



CARDINAL®



825 Gen2 INDICATOR

Desktop Weight Indicator Installation and Technical Manual

INTRODUCTION

Thank you for selecting and purchasing the Cardinal Model 825 Desktop Weight Indicator. The Model 825 Desktop indicator was built with quality and reliability and incorporates the latest in digital technology and innovative features for the weighing industry. Configuration and upgrades can easily be performed in the field, while still maintaining the rigid control the most demanding installations require. This flexibility ensures the Model 825 Desktop Weight Indicator will be able to meet your weight indicating needs for years to come.

The purpose of this manual is to provide you with a guide through the installation, setup, and calibration of your new Model 825 Desktop Weight Indicator. Please read it thoroughly before attempting to install your indicator and keep it handy for future reference.

COPYRIGHT

All rights reserved. Reproduction or use, without express written permission, of editorial or pictorial content, in any manner, is prohibited. No patent liability is assumed with respect to the use of the information contained herein.

DISCLAIMER

While every precaution has been taken in the preparation of this manual, the Seller assumes no responsibility for errors or omissions. Neither is any liability assumed for damages resulting from the use of the information contained herein. All instructions and diagrams have been checked for accuracy and ease of application; however, success and safety in working with tools depend largely upon individual accuracy, skill, and caution. For this reason, the Seller is not able to guarantee the result of any procedure contained herein. Nor can they assume responsibility for any damage to property or injury to persons occasioned by the procedures. Persons engaging in the procedures do so entirely at their own risk.

SERIAL NUMBER _____
DATE OF PURCHASE _____
PURCHASED FROM _____

RETAIN THIS INFORMATION FOR FUTURE USE

PRECAUTIONS

Before using this indicator, read this manual and pay special attention to all "NOTIFICATION" symbols:



IMPORTANT



**ELECTRICAL
WARNING**

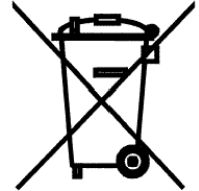


**STATIC
SENSITIVE**

PROPER DISPOSAL

When this device reaches the end of its useful life, it must be properly disposed of. It must not be disposed of as unsorted municipal waste. Within the European Union, this device should be returned to the distributor from where it was purchased for proper disposal. This is in accordance with EU Directive 2002/96/EC. Within North America, the device should be disposed of in accordance with the local laws regarding the disposal of waste electrical and electronic equipment.

It is everyone's responsibility to help maintain the environment and to reduce the effects of hazardous substances contained in electrical and electronic equipment on human health. Please do your part by making certain that this device is properly disposed of. The symbol shown to the right indicates that this device must not be disposed of in unsorted municipal waste programs.



CAUTION



CAUTION: RISK OF EXPLOSION IF BATTERY IS REPLACED BY AN INCORRECT TYPE. DISPOSE OF USED BATTERIES ACCORDING TO THE INSTRUCTIONS.

ATTENTION: RISQUE D'EXPLOSION SI LA BATTERIES EST REMPLAC'E PAR UN TYPE INCORRECT. REJETEZ LES BATTERIES UTILISE'ES SELON LES INSTRUCTIONS.

Contains FCC ID: 2ADHKWINC3400

1. This device complies with Part 15 of the FCC rules. Operation is subject to the following two conditions:
 - (1) This device may not cause harmful interference.
 - (2) This device must accept any interference received, including interference that may cause undesired operation.
2. Changes or modifications not expressly approved by the party responsible for compliance could void the user's authority to operate the equipment.

FCC RADIATION EXPOSURE STATEMENT

This equipment complies with FCC RF radiation exposure limits set forth for an uncontrolled environment. This transmitter must not be co-located or operated in conjunction with any other antenna or transmitter.

TABLE OF CONTENTS

SPECIFICATIONS	Page 1
FEATURES	Page 2
APPLICATION SOFTWARE USED IN TRADE	Page 3
PRECAUTIONS	Page 4
Static Electricity	Page 4
SITE PREPARATION REQUIREMENTS	Page 5
Environmental	Page 5
Electrical Power	Page 6
Electrical Noise Interference	Page 6
Transient Suppression	Page 6
RFI Immunity	Page 7
INSTALLATION	Page 9
Placement	Page 9
Indicator Power Switch and Gland Connector Layout	Page 10
825 Internal I/O Ports	Page 10
Load Cell Cable Connection with RFI Suppression	Page 11
Load Cell Cable Connection <u>without</u> RFI Suppression	Page 14
Load Cell Connections with Over 30 Feet of Cable	Page 14
Serial and I/O Cable Installation	Page 15
RS232 Terminal Connections	Page 16
20mA Terminal Connections	Page 18
RS485 Terminal Connections	Page 19
I/O (Input/Output) Terminal Connections - 825 Source Power	Page 20
I/O (Input/Output) Terminal Connections - <u>External</u> Power Source	Page 21
MAIN PC BOARD	Page 22
Jumpers	Page 23
Connectors	Page 24
Status LED's	Page 25
825-SIB (SCALE INPUT BOARD)	Page 26
CLOSING THE FRONT DISPLAY PANEL	Page 27
TOUCHSCREEN FUNCTIONS	Page 28
Navigation Keys	Page 29
Qwerty Keyboard	Page 29
Standard Indicator Keys	Page 31
Application Program Keys	Page 34
ANNUNCIATORS	Page 37

TABLE OF CONTENTS, CONT.

SETUP	Page 38
Calibration Jumper (J11 – CAL INHIBIT)	Page 38
To Begin Setup	Page 41
Display <u>M</u> ode	Page 43
<u>L</u> anguage	Page 46
<u>C</u> ommunication	Page 47
Network	Page 47
Ethernet	Page 47
Bluetooth	Page 51
WiFi	Page 52
Services	Page 55
Comm Port 1 Defaults	Page 59
Comm Port 2 Defaults	Page 62
Comm Port 3 Defaults	Page 64
Calibration	Page 66
Setup Scale Number	Page 66
Scale 1 – Calibration - General	Page 67
Scale 1 – Calibration - Conversion	Page 70
Scale 1 – Calibration - Filtering	Page 72
Filter Setting Recommendations	Page 75
Scale 1 – Calibration - Options	Page 76
Scale 1 – Calibration - Other Options	Page 78
Scale 1 – Calibration - Multi Interval	Page 80
Calibration Methods	Page 85
Calibration after Entering Scale Parameters	Page 85
Calibration from the Setup Menu	Page 89
Fine Span Adjustment	Page 94
Fine Span Adjustment with 2nd Order Linearization	Page 95
Review Setup Parameters	Page 98
Totalizer Function	Page 99
<u>T</u> otal	Page 99
Total - Calibration - Filtering	Page 101
Total - Calibration - Options	Page 104
Total - Calibration - Other Options	Page 106
Total - Calibration - Multi Interval	Page 108
Totalizer	Page 113
Select Scale to Calibrate	Page 114
Calibrate Selected Scale	Page 114

TABLE OF CONTENTS, CONT.

Preferences	Page 118
Preferences Menu	Page 118
<u>D</u> ate/Time	Page 118
<u>C</u> olor Scheme	Page 124
<u>C</u> olor Palette	Page 128
<u>L</u> CD Settings	Page 129
<u>S</u> ound Settings	Page 131
DATE/TIME	Page 136
OPERATORS	Page 138
<u>1.</u> List Operators	Page 140
<u>2.</u> Add Operators	Page 141
<u>3.</u> Edit Operators	Page 145
<u>4.</u> Delete Operators	Page 149
<u>5.</u> Set Default Operators	Page 151
SERVICES	Page 152
DIAGNOSTICS	Page 157
Diagnostics Menu	Page 159
Storage Info	Page 160
Mainboard I/O	Page 161
Comm Ports	Page 162
USB Ports	Page 163
Network	Page 164
Sound	Page 166
Option Cards	Page 167
Ambient Light	Page 168
Return to Normal Operations	Page 169
EVENT COUNTERS	Page 171
To View the Event Counters	Page 171
Return to Normal Operations	Page 173
CERTIFICATIONS / ID INFORMATION	Page 174
To View the Certifications / ID Information	Page 174
Return to Normal Operations	Page 176
LOCK AND WIRE SECURITY SEAL INSTALLATION	Page 177

TABLE OF CONTENTS, CONT.

PARTS IDENTIFICATION	Page 178
Final Assembly Parts List	Page 178
Final Assembly – ISO View	Page 179
Final Assembly – Open Flat View	Page 180
Final Assembly – Section B-B View	Page 181
Final Assembly – Bottom View	Page 181
Rear Enclosure Parts List	Page 182
Rear Enclosure – Open Flat View	Page 183
Rear Enclosure – Base Assembly, No Lid View	Page 184
Rear Enclosure – Base Assembly, No Lid, No Power Supply Guard View	Page 184
Desktop Screen Assembly Parts List	Page 185
Desktop Screen Assembly – Rear View	Page 186
Desktop Screen Assembly – Exploded View	Page 187

SPECIFICATIONS

Power Requirements:	100 to 240 VAC (50/60 Hz) at 1A Max.
Enclosure Type:	Painted Mild Steel Desktop Mount
Enclosure Size:	14.25 in W x 10.5 in H x 11.75 in D (36.2 cm W x 26.7 cm H x 29.9 cm D)
Net Weight:	15 lb (6.5 kg)
Shipping Weight:	17 lb (7.7 kg)
Operating Environment:	Temperature: 14 to 104 °F (-10 to +40 °C) Humidity: 90% non-condensing (maximum)
Display Size:	12.1 in (307 mm) Diagonal Active Area: 10.3 in W x 6.4 in H (261 mm W x 163 mm H)
Display Resolution:	1280 x 800 Color Graphics TFT LCD w/ LED Backlight
Transducer Excitation:	10.85 VDC
Signal Input Range:	1.0 mV min. to 33 mV max. (with dead load boost)
Number of Load Cells:	14 each, 350 OHM minimum resistance
Load Cell Cable Length:	1260 feet maximum with sense lines (Consult the factory for other requirements) 30 feet maximum without sense lines
Division Value:	Commercial: 1, 2, or 5 x 10, 1, 0.1, 0.01, 0.001, and 0.0001 Non-commercial: 0 to 99
Sensitivity: NON-COMMERCIAL NTEP CANADA OIML	0.15 uV/e 0.3uV/e (Class III/IIIL) 0.3uV/e (Class III/IIIHD) 0.5 uV/e (Class III)
Scale Divisions: NON-COMMERCIAL NTEP CANADA OIML	100 to 240,000 100 to 10,000 (Class III/IIIL) 100 to 10,000 (Class III/IIIHD) 100 to 10,000 (Class III), 1,000 (Class IIII)
Internal Resolution:	> 100,000 Counts
Tare Capacity:	Six Digits (999,999)
Sample Rate:	1 to 200 samples per second, selectable
Auto Zero Range:	0.5 or 1 through 9 divisions
Weighing Units:	Tons, Pounds, Tonnes (Metric Tons), and Kilograms
Keypad:	Interactive touchscreen
Standard I/O:	(1) Bi-directional RS-232 port (1) Bi-directional RS-232/20mA port (1) Bi-directional RS-232/RS485 port (1) 10/100/1000 Base-T Ethernet (4) Isolated input/output (2) USB 3.0 ports, (1) USB 2.0 port, and (1) USB C port (1) HDMI port 802.11b/g/n WiFi Bluetooth v4.2 BR/EDR/BLE

FEATURES

Standard

- 4GB memory standard
- 16GB onboard memory storage
- Up to 256GB USB memory storage
- Menu-driven set-up and configuration
- Time and Date with selectable 12 or 24 hour operation
- Adjustable Filtering
- Multi-Point Calibration
- Gross, Tare, and Net Conversion
- Multi-Interval Feature
- Push Button and Keypad Tare Function
- SMA Level 2 Compliant Serial Communications (See www.scalemanufacturers.org)
- Interactive Touch Screen
- Up to Eight Operators (one administrator and seven configurable users)
- Includes standard applications
- Truck/ID storage
- DFC Batcher
- Check Weigher
- Highway Weigh Station
- Multi-Scale
- File Manager

Optional

- Eight option card slots (*Seven are available with included installed 825-SIB.*)
- 825-SIB High-Speed Scale Input Board
- 825-DLC Digital Load Cell Interface*
- 825-DIO Digital Input/Output (provides 8 configurable digital input and output lines) *
- 825-DAC Analog Output Card (0 to 10v or 4 to 20 mA) *

* Requires additional hardware and includes additional documentation.

Models

- 825A-D – 825 Desktop Mount for Analog Scales
- 825D-D – 825 Desktop Mount for Digital Scales

APPLICATION SOFTWARE USED IN TRADE

1. Must be evaluated and accepted by a responsible metrology authority.
In the EU, this is the TSO (Technical Services Official).
In the US and Canada, the metrology inspector responsible for your area.
2. If you have more than one indicator using the same application program, you may have to obtain an NTEP Certificate of Conformance. Check with your local Weights and Measures inspector for more information.
3. The application program cannot be loaded into the indicator or, once in, cannot be modified as long as the calibration inhibit jumper is installed.
4. Provisions are included for verifying the metrological integrity of the displayed and transmitted weights from the application program:
 - A. Displayed Weight
 1. With the application program running, place a weight on the load-receiving platform.
 2. Record the weight value. (Do not remove the weight)
 3. Return to the Menu Screen (turn power off then on) and select the standard (STD) program.
 4. When the weight is displayed, verify it is the same as that recorded in step No. 2.
 - B. Transmitted Weight
 1. With the application program running, connect a display terminal device (Laptop, PC, Display, etc.) to COM1.
 2. Observe the Gross weight being transmitted by the standard (STD) program from COM1. (Note that COM1 is under the exclusive control of the standard (STD) program when the indicator is configured for "Trade" or legal applications).
 3. Observe the Gross weight transmitted from a port utilized by the application program (any port but COM1). This weight must be identical to that observed in step No. 2.
5. When developing application programs for use in Trade, you should check with the responsible metrology authorities to ensure that your program employs the proper safeguards.

PRECAUTIONS

Static Electricity



CAUTION! This device contains static-sensitive circuit cards and components. Improper handling of these devices or printed circuit cards can result in damage to or destruction of the component or card. Such actual and/or consequential damage IS NOT covered under the warranty and is the responsibility of the device owner. Electronic components must be handled only by qualified electronic technicians who follow the guidelines listed below:



ALWAYS handle printed circuit card assemblies by the outermost edges. NEVER touch the components, component leads, or connectors.

ALWAYS observe warning labels on static protective bags and packaging and NEVER remove the card or component from the packaging until ready for use.

ALWAYS store and transport electronic printed circuit cards and components in anti-static protective bags or packaging.



ATTENTION! ALWAYS use a properly grounded wrist strap when handling, removing, or installing electronic circuit cards or components. Make certain that the wrist strap ground lead is securely attached to an adequate ground. If you are uncertain of the quality of the ground, you should consult a licensed electrician.

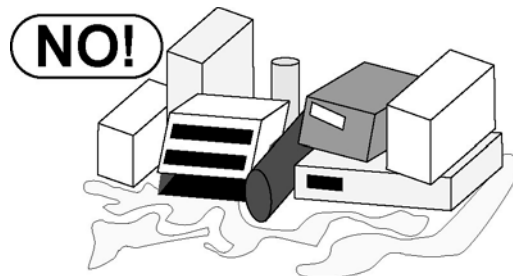
SITE PREPARATION REQUIREMENTS

The Model 825 Desktop Weight Indicator is a precision weight-measuring instrument. As with any precision instrument, it requires an acceptable environment to operate at its peak performance and reliability. This section is provided to assist you in obtaining such an environment.

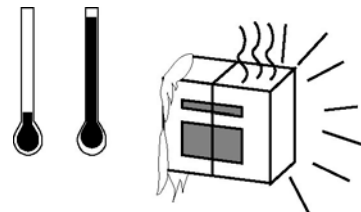
Environmental

The Model 825 Desktop Weight Indicator meets or exceeds all certification requirements within a temperature range of 14 to 104 °F (-10 to +40 °C).

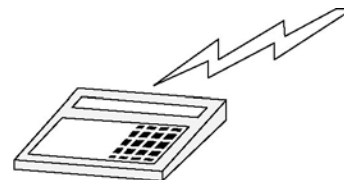
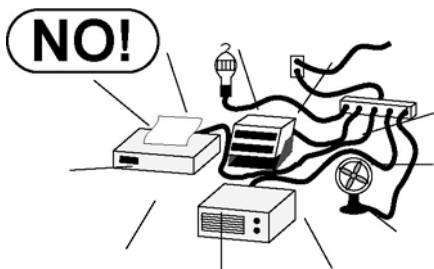
In order to keep cooling requirements to a minimum, the indicator should be placed out of direct sunlight and to provide adequate air circulation, keep the area around the indicator clear.



Make certain the indicator is not directly in front of a heating or cooling vent. Such a location will subject the indicator to sudden temperature changes, which may result in unstable weight readings.



Insure that the indicator has good, clean AC power and is properly grounded. In areas subject to lightning strikes, additional protection to minimize lightning damage, such as surge suppressors, should be installed.



SITE PREPARATION REQUIREMENTS, CONT.

Electrical Power

The Model 825 Desktop Weight Indicator has been designed to operate from 100 to 240 VAC at 50/60 Hz. Note that a special order is not required for operation at 230/240 VAC.



CAUTION! - To avoid electrical hazards and possible damage to the indicator, DO NOT, under any circumstance, cut, remove, alter, or in any way bypass the power cord grounding prong.

- The socket outlet supplying power to the indicator should be on a separate circuit from the distribution panel and dedicated to the exclusive use of the indicator.
- The socket outlet shall be installed near the equipment and shall be easily accessible. Note that the AC power cord on the 825 or the push-button power switch (located on the rear enclosure above the AC power cord) serves as the power disconnect.
- The wiring should conform to national and local electrical codes and ordinances and should be approved by the local inspector to ensure compliance.
- For outdoor operations, the socket-outlet must provide GFCI (ground fault circuit interrupter) protection.
- On installations requiring 230/240 VAC power, **it is the responsibility of the customer** to have a qualified electrician install the proper power cord plug that conforms to national electrical codes and local codes and ordinances.

Electrical Noise Interference

To prevent electrical noise interference, make certain all other wall outlets for use with air conditioning and heating equipment, lighting, or other equipment with heavily inductive loads, such as welders, motors, and solenoids are on circuits separate from the indicator. Many of these disturbances originate within the building itself and can seriously affect the operation of the instrument. These sources of disturbances must be identified and steps must be taken to prevent possible adverse effects on the instrument. Examples of available alternatives include isolation transformers, power regulators, uninterruptible power supplies, or simple line filters.

Transient Suppression

The following recommendations will help to reduce transients:

- Always use shielded cables to connect signal wires to the weight indicator.
- Secure the cables in the cable clips provided inside the indicator.
- Connect the cable shield (indicator end only) to a ground point inside the indicator. Keep wires that extend beyond the shield as short as possible.
- Do not run load cell or signal cables from the weight indicator alongside or parallel to wiring carrying AC power. If unavoidable, position the load cell and signal cables a minimum of 24" away from all AC wiring.
- Always use arc suppressors across all AC power relay contacts (see recommendations at https://d2f6h2rm95zq9t.cloudfront.net/32376511/QRL_Quencharc_21185346.pdf)
- Use zero voltage switching relays, optically isolated if possible.

SITE PREPARATION REQUIREMENTS, CONT.

RFI Immunity

The operation of sensitive electronic equipment can be adversely affected by RF (Radio Frequency) radio transmissions. Digital weight indicators are one such type of equipment. Radio transmissions come from things like hand-held radio transmitters and cell phones. One symptom of RFI (Radio Frequency Interference) in a digital weight indicator is weight indication instability during a radio transmission.

Cardinal digital weight indicators are designed with special grounding and RFI shielding to achieve a high degree of immunity to common RFI. To maximize the digital weight indicator's immunity to radio transmissions, follow these guidelines:

1. ALWAYS use shielded cable for all I/O (Input/Output) connections to the digital weight indicator.
2. NEVER operate any radio transmitter within 2 meters (~6ft.) of the weight indicator.
3. NEVER connect un-terminated serial, digital, or analog I/O cables to the internal printed circuit boards of the digital weight indicator.
4. KEEP the intended external I/O device connected to I/O cables entering the digital weight indicator.
5. ALWAYS connect the shield of the shielded cable to the indicator back panel gland connector or other closest ground terminal inside the indicator.
6. ALWAYS connect the shield of the shielded I/O cable at the indicator end only. Leave the shield unconnected at the I/O device.

INSTALLATION

Before beginning installation of your Model 825 Desktop Weight Indicator, make certain that it has been received in good condition. Carefully remove it from the shipping carton and inspect it for any evidence of damage (such as exterior dents or scratches) that may have taken place during shipment. Keep the carton and packing material for return shipment if it should become necessary. It is the responsibility of the purchaser to file all claims for any damages or loss incurred during transit.

Placement

The Model 825 Desktop Weight Indicator is housed in a mild steel enclosure designed to be placed on a desk, table, or other smooth, flat, horizontal surface. Refer to Figure No. 1.



Figure No. 1

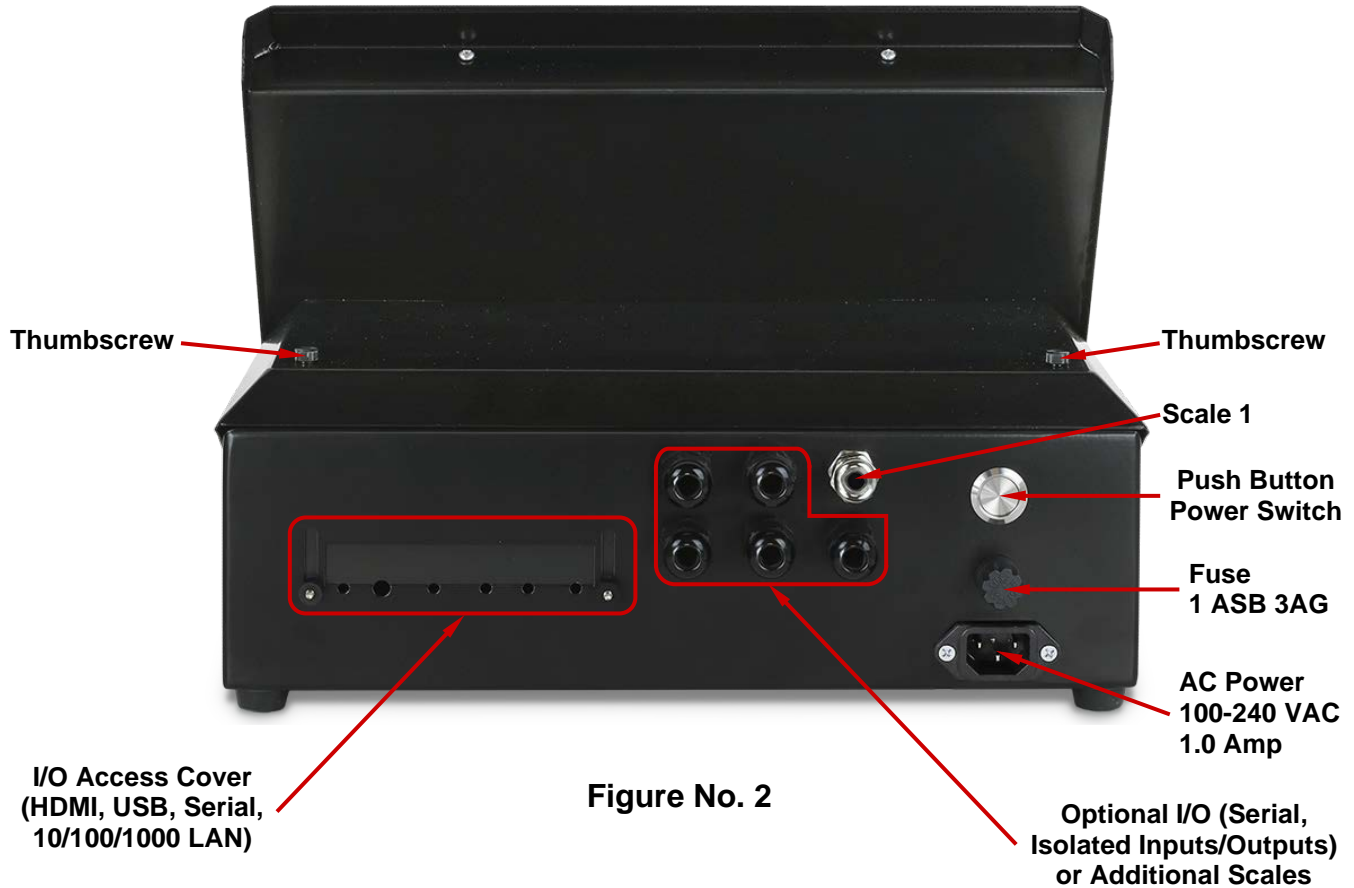
Position the indicator on a stable, flat, and level surface, ensuring it is shielded from direct sunlight and any swiftly moving air sources such as heating or cooling vents, and fans. Route the power cord and peripheral cables away from regular traffic pathways. Optimal placement of the indicator should prioritize easy visibility of the display while also providing convenient access to the keypad for operators.

INSTALLATION, CONT.

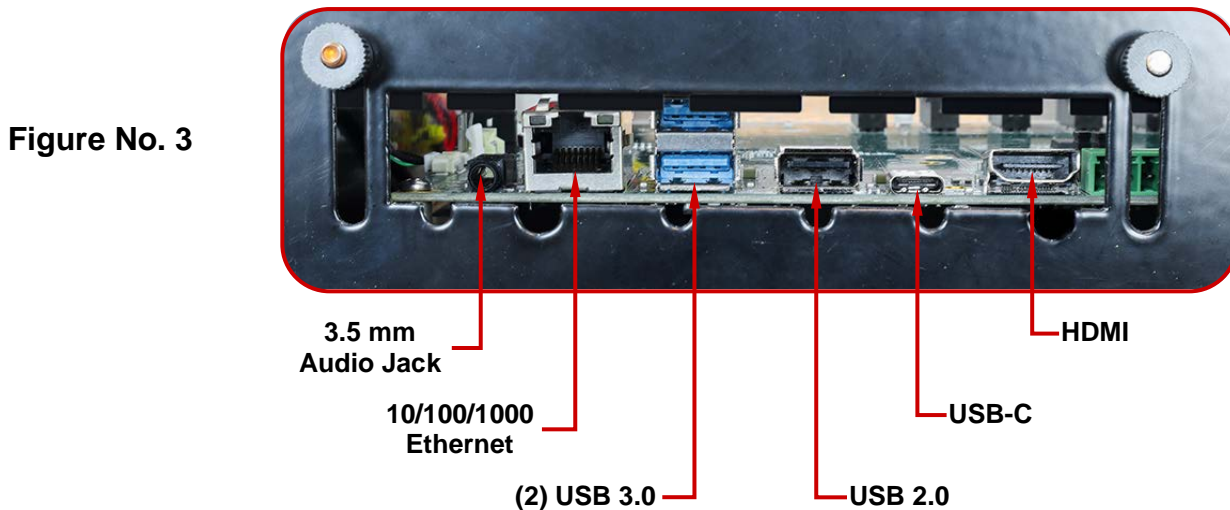
Indicator Power Switch and Gland Connector Layout

PUSH-BUTTON POWER SWITCH

The push-button power switch located on the rear enclosure above the AC power cord is used to power the indicator on and off. If the indicator is off, pressing this switch will turn the indicator ON. If the indicator is already on, pressing this switch will turn it OFF.



825 Internal I/O Ports



INSTALLATION, CONT.

Load Cell Cable Connection with RFI Suppression



WARNING! Disconnect any external load cell power supply before connecting load cells to the indicator. Failure to do so will result in permanent damage to the indicator.

To eliminate RFI, the load cell cable should be routed through the special metallic gland connector, and the shield wire from the load cell cable must be connected to this gland connector for grounding. Refer to Figure No. 2 for the gland connector layout.

1. Referring to Figure No. 2, remove the two (2) thumbscrews securing the hinged front display panel to the base enclosure. Next, referring to Figure No. 4, pull forward on the panel and then lower the front display panel until it is completely opened. See Figure No. 5.



Figure No.4



Figure No. 5

2. Loosen and remove the metal gland connector nut and then remove the plastic insert.

3. Referring to Figure No. 6, route the single cable from the load cell or load cell junction box through the nut and plastic insert and into the base enclosure.

4. With the load cell cable routed into the base enclosure, refer to Figure No. 6 and then remove approximately 6 inches of the cable outer insulating jacket exposing the internal wires.

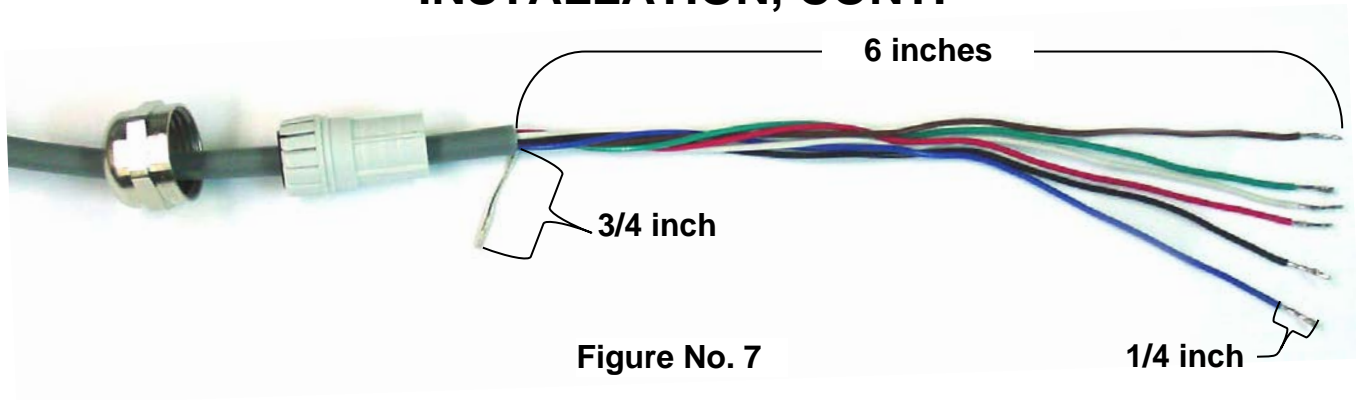
5. Next, cut the shield wire so that it extends past the outer jacket approximately 3/4 inch.

6. Now, remove 1/4 inch of insulation from the end of each of the six wires (with sense leads) or four wires (without sense leads).

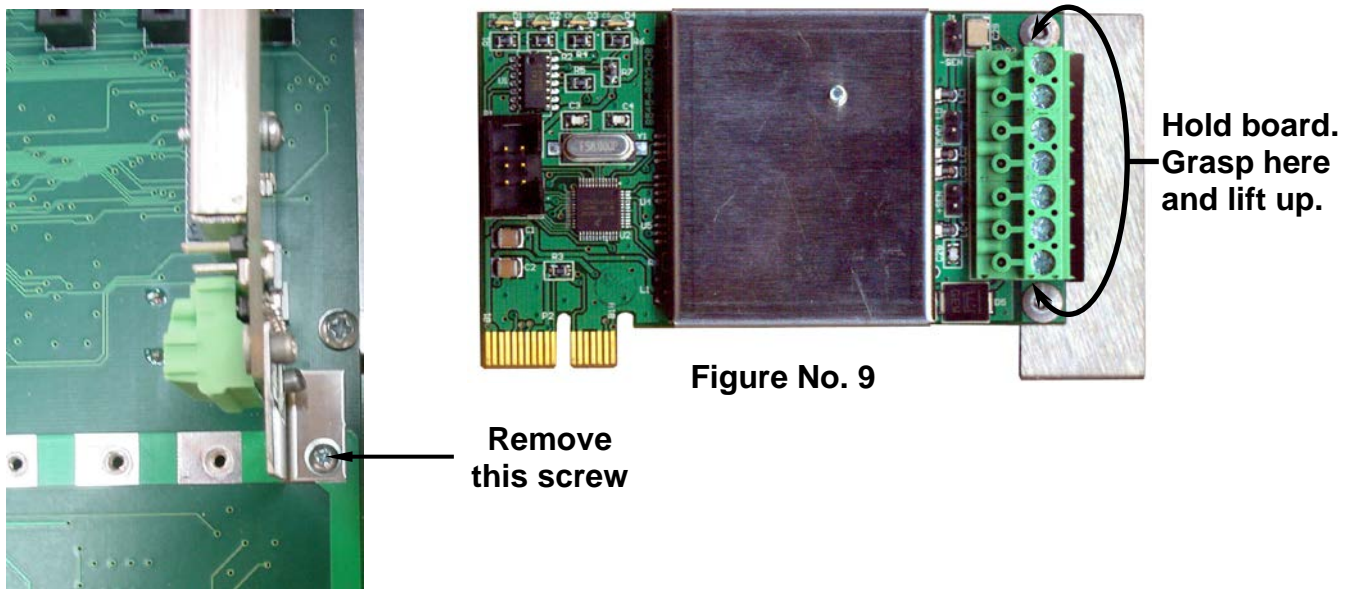


Figure No. 6

INSTALLATION, CONT.



7. Remove the screw securing the 825 Scale Input Board (825-SIB) to the main PC board and then lift the 825-SIB straight up to remove it from the base enclosure. See Figure No. 8.
8. Remove the 7-conductor terminal from the 825-SIB. (Hold the board in place, grasp the terminal block connector, and lift straight up away from the board). See Figure No. 9.



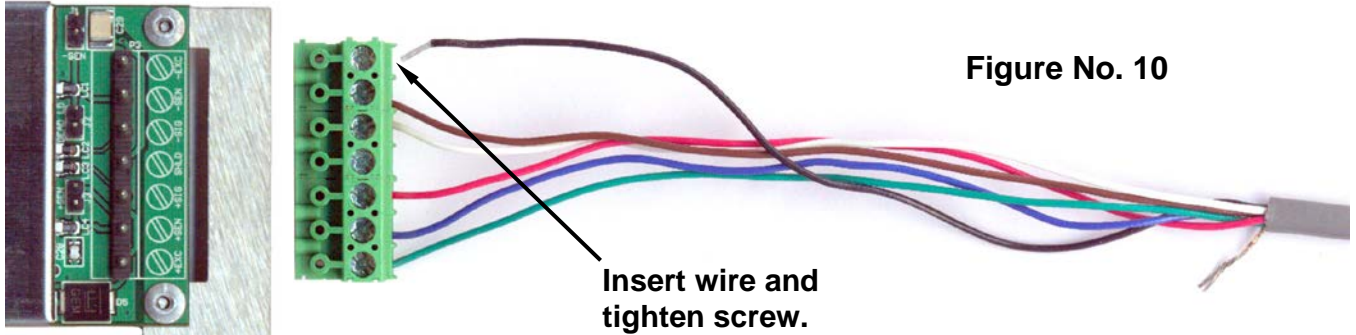
9. Referring to the table below and the labels on the circuit board for terminal connections, connect each wire to the terminal block.

Load Cell Wiring Table

Board Label	Function	Board Label	Function
+EXC	+ EXCITATION	-SIG	- SIGNAL
+SEN	+ SENSE	-SEN	- SENSE
+SIG	+ SIGNAL	-EXC	- EXCITATION
SHLD	SHIELD (Not used, the shield wire is connected to the metal gland).		

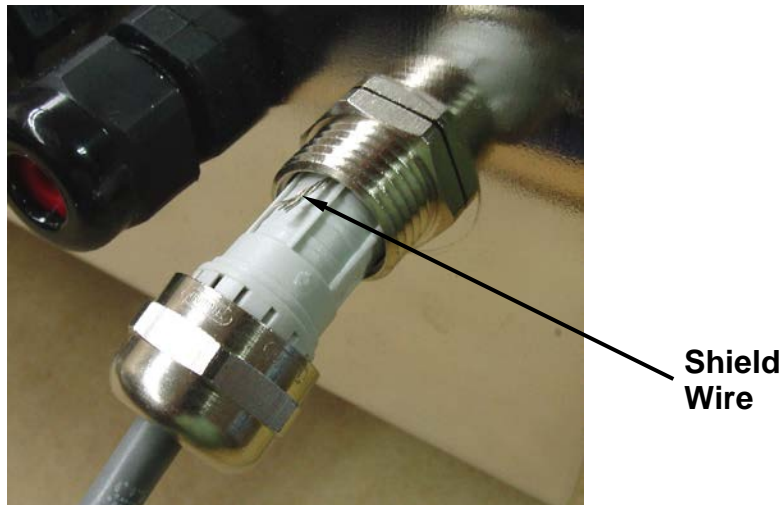
INSTALLATION, CONT.

10. To terminate a wire, loosen the screws in the terminal block and then insert the wire into the terminal opening. Tighten the screw to secure the wire in place. See Figure No. 10.
11. Repeat the procedure until all wires are in place.

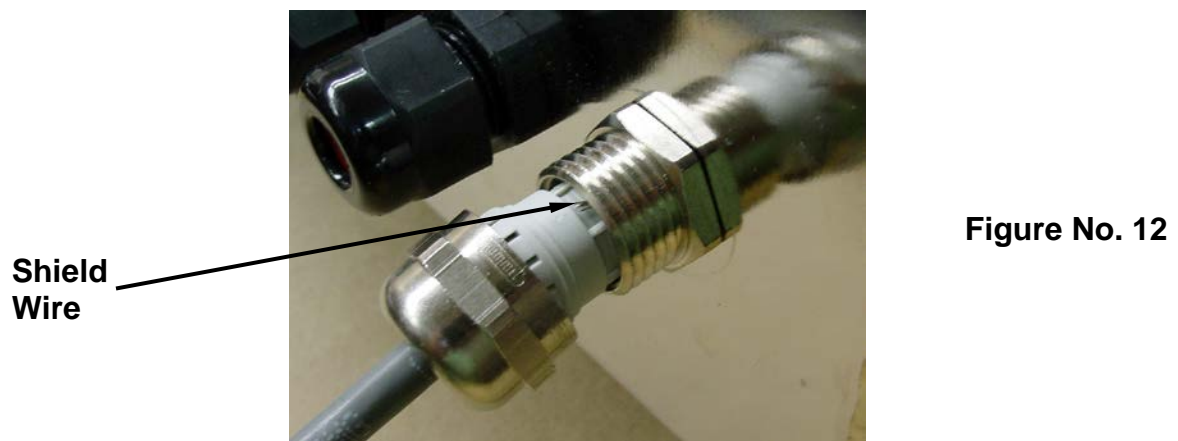


12. After all terminations have been made, remove the excess cable from the base enclosure.
13. Referring to Figure No. 11, fold the shield wire back over the plastic insert and then insert the plastic insert (with the shield wire) into the gland connector.

Figure No. 11



14. The shield wire is secured when tightening the gland connector nut. Do not over-tighten the connector but make certain it is snug. See Figure No. 12.



INSTALLATION, CONT.

Load Cell Cable Connection without RFI Suppression

The following instructions describe the load cell connection without RFI Suppression should it not be required. Refer to Figure No. 2 for the gland connector layout.

1. Referring to Figure No. 2, remove the two (2) thumbscrews securing the hinged front display panel to the base enclosure. Next, referring to Figure No. 4, pull forward on the panel and then lower the front display panel until it is completely opened. See Figure No. 5.
2. Choose a gland connector for the load cell cable and loosen it.
3. Slip the single cable from the load cell or load cell junction box through the gland connector and into the enclosure.

4. Referring to Figure No. 13, remove 3 inches of the outer insulation jacket of the load cell cable.

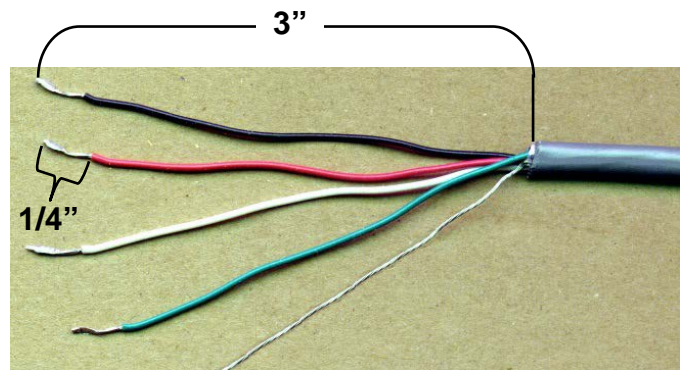


Figure No. 13

5. Next, remove 1/4 inch of insulation from each of the four wires and shield (without sense leads) or six wires and shield (with sense leads).
6. Referring to the table below and the labels on the circuit board for terminal connections, connect each wire to the terminal block.

Load Cell Wiring Table

Board Label	Function	Board Label	Function
+EXC	+ EXCITATION	-SIG	- SIGNAL
+SEN	+ SENSE	-SEN	- SENSE
+SIG	+ SIGNAL	-EXC	- EXCITATION
SHLD	SHIELD (Connect the load cell cable shield wire here).		

7. To terminate a wire, loosen the screws in the terminal block and then insert the wire into the terminal opening. Tighten the screw to secure the wire in place. See Figure No. 10.
8. Repeat the procedure until all wires are in place.

Load Cell Connections with Over 30 Feet of Cable

For installations with over 30 feet of cable between the 825 and the load cells, sense wires should be used. The sense wires must be connected between the +SENS, -SENS terminals on the 825-SIB (Scale Input Board) and the +EXCITATION, -EXCITATION wires of the load cells or the +SENS, -SENS terminals of the load cell trim board (or the section seal trim board). For the 825-SIB to use the sense wires, the -SENS and +SENS jumpers J1 and J3 must be open (on one pin only) or removed. Refer to Figure No. 23 for the location of these jumpers.

INSTALLATION, CONT.

Serial and I/O Cable Installation

The 825 indicator may be connected to a printer to record weight and associated data or it may be connected to a remote display or even to a computer for transmission of weight data. The weight data may be transmitted on demand (by pressing the **PRINT** key or on receipt of a command from the computer).

1. Referring to Figure No. 2, remove the two (2) thumbscrews securing the hinged front display panel to the base enclosure. Next, referring to Figure No. 3, pull forward on the panel and then lower the front display panel until it is completely opened. See Figure No. 4.
2. Choose a gland connector for the I/O cable and loosen it.
3. Slip the cable through the gland connector and into the enclosure.
4. Referring to Figure No. 14, remove 3 inches of the outer insulation jacket of the cable.
5. Next, remove 1/4 inch of insulation from each of the wires.
6. Referring to the corresponding I/O tables and figures in the next sections, connect each wire to the terminal block.
7. To terminate a wire, loosen the screws in the terminal block and then insert the wire into the terminal opening. Tighten the screw to secure the wire in place.
8. Repeat the procedure until all wires are in place.

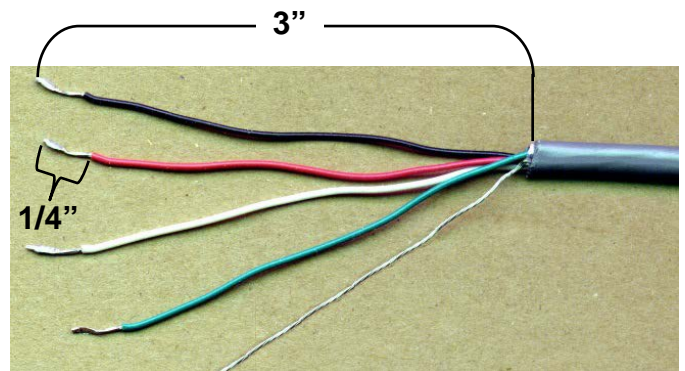


Figure No. 14

INSTALLATION, CONT.

RS232 Terminal Connections

Refer to the tables below and Figure No. 15 on the next page to connect each wire to the terminal block.

RS232 COM1 - TERMINAL P22

Terminal	Function
1	TXD (Transmit)
2	RXD (Receive)
3	RTS (Ready To Send)
4	CTS (Clear To Send)
5	GND (Ground)

IMPORTANT!

- **COM1** is RS232 only (no jumper or shunt).
- **COM2** requires **J7** shunt installed on RS232.
- **COM3** requires **J8** shunt installed on RS232.

RS232 COM2 - TERMINAL P21

Terminal	Function
1	TXD (Transmit)
2	RXD (Receive)
3	NC
4	5V/.25A (5 VCD @ .25A)
5	GND (Ground)

RS232 COM3 - TERMINAL P20

Terminal	Function
1	TXD (Transmit)
2	RXD (Receive)
3	NC
4	5V/.25A (5 VCD @ .25A)
5	GND (Ground)

INSTALLATION, CONT.

RS232 Terminal Connections, Cont.

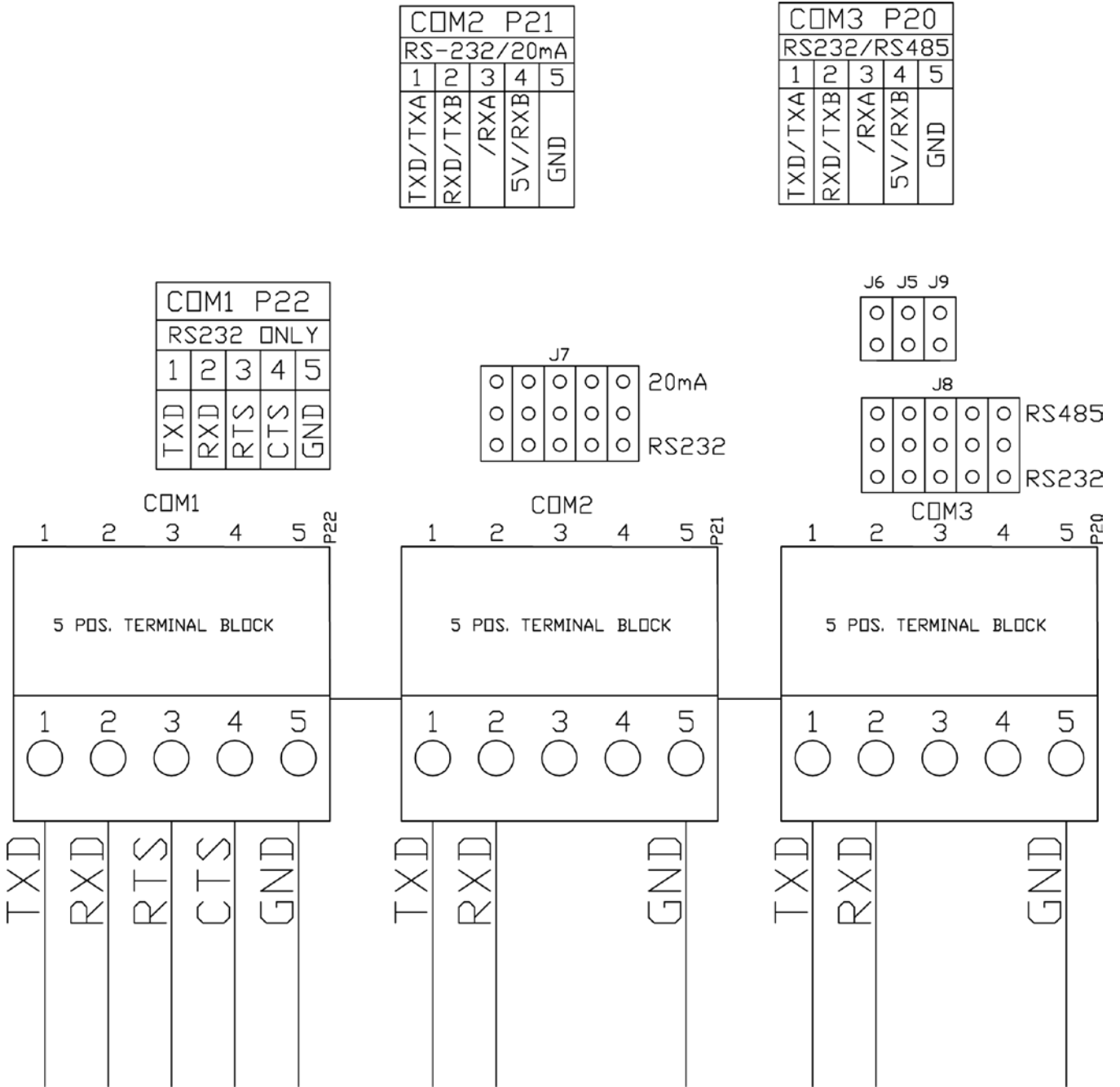


Figure No. 15

INSTALLATION, CONT.

20mA Terminal Connections

Refer to the table and Figures No. 16 and 17 below to connect each wire to the terminal block.

20mA COM2 - TERMINAL P21

Terminal	Function
1	TXA (Transmit A)
2	TXB (Transmit B)
3	RXA (Receive A)
4	RXB (Receive B)
5	GND (Ground)

IMPORTANT!

- **COM2** requires **J7** shunt installed on 20mA.
- **825 Active** requires **J3** installed.
- **825 Passive** requires **J3** removed.

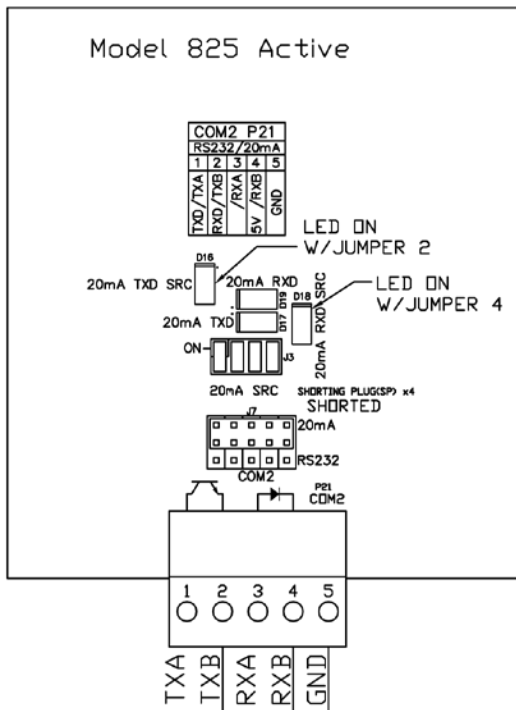


Figure No. 16

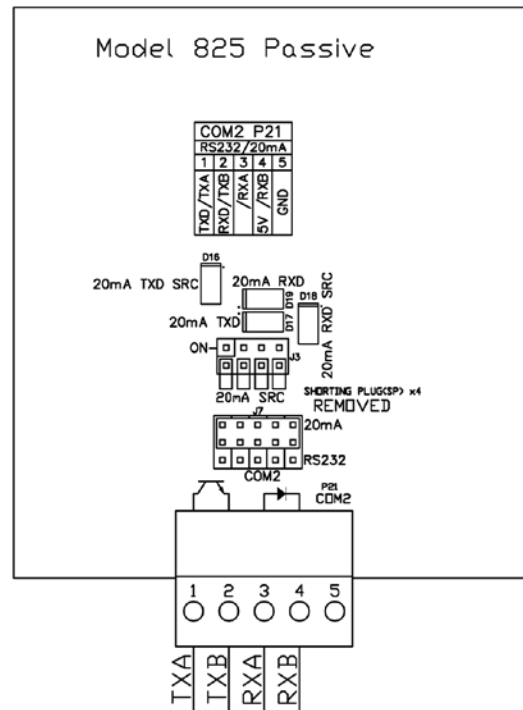
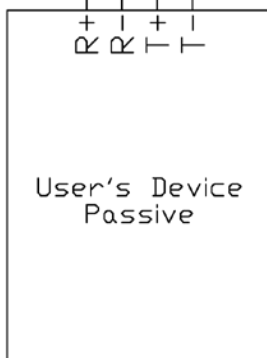
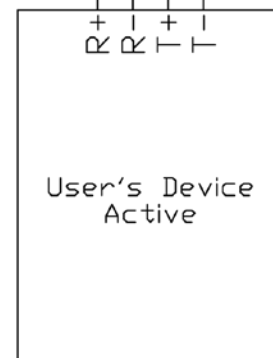


Figure No. 17



INSTALLATION, CONT.

RS485 Terminal Connections

Refer to the table and Figures No. 18 and 19 below to connect each wire to the terminal block.

RS485 COM3 - TERMINAL P20

Terminal	Function
1	TXA (Transmit A)
2	TXB (Transmit B)
3	RXA (Receive A)
4	RXB (Receive B)
5	GND (Ground)

IMPORTANT!

- **COM3** requires **J8** shunt installed on RS485.
- **2-Wire** requires **J5** and **J6** installed.
- **4-Wire** requires **J5** and **J6** removed.
- Install **J9** if the 825 is last device on the RS-485 bus.

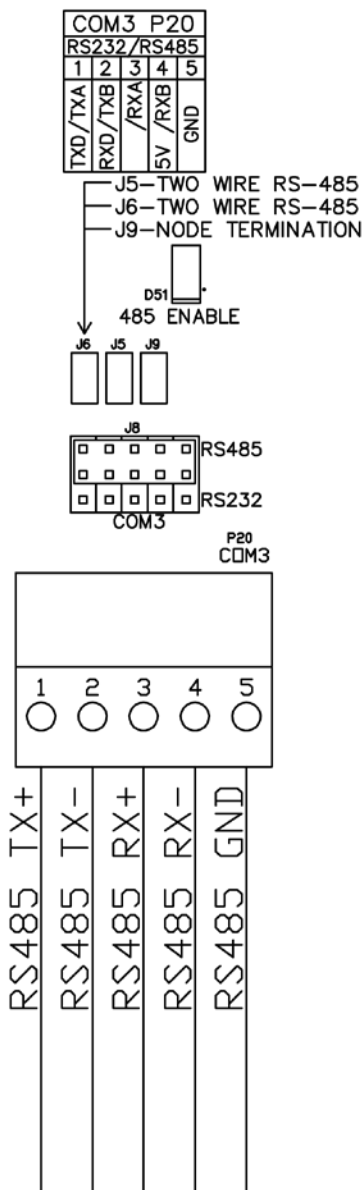


Figure No. 18

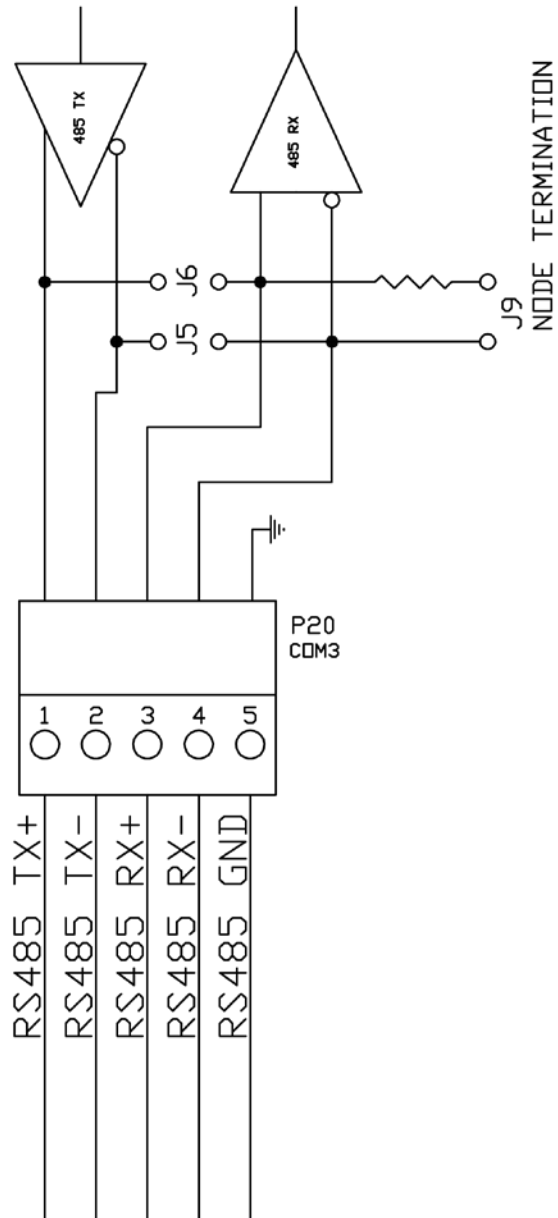


Figure No. 19

INSTALLATION, CONT.

I/O (Input/Output) Terminal Connections - 825 Source Power

Refer to the table and Figure No. 20 below to connect each wire to the terminal block.

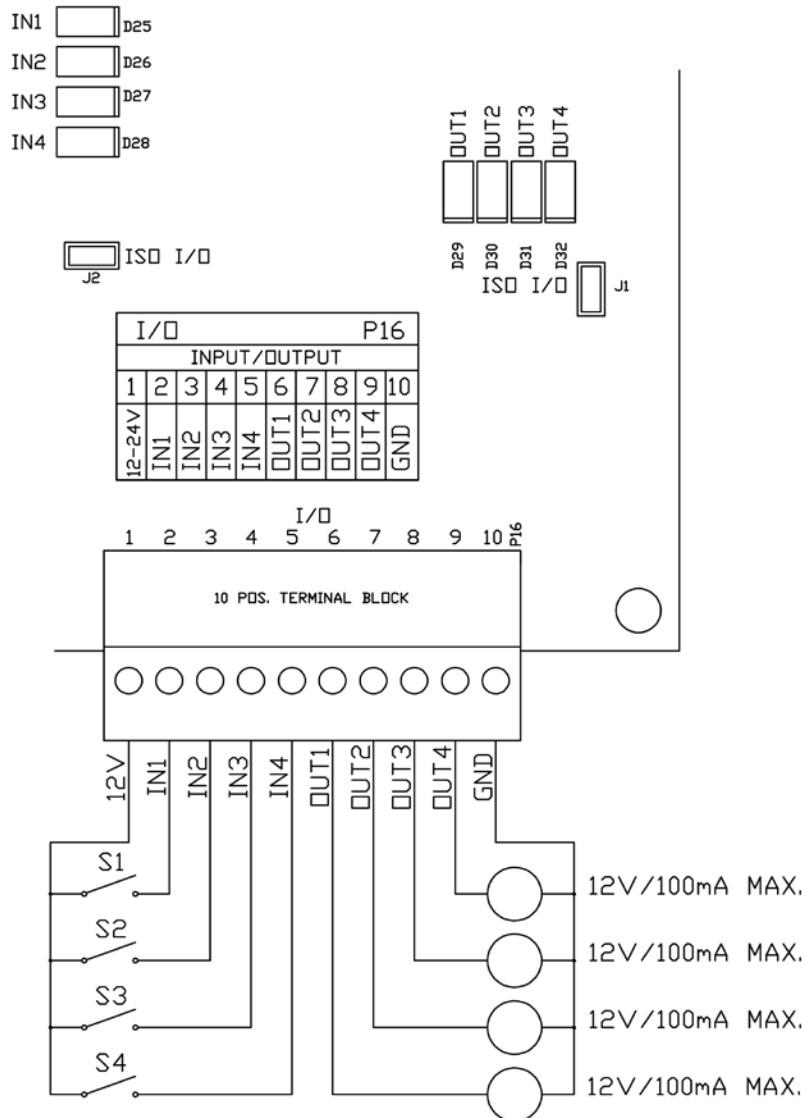
INPUT/OUTPUT - TERMINAL P16 (825 SOURCE POWER)

Terminal	Function	Terminal	Function
1	12v (12VDC from 825)	6	OUT1 (Output 1 @ 100mA MAX.)
2	IN1 (Input 1)	7	OUT2 (Output 2 @ 100mA MAX.)
3	IN2 (Input 2)	8	OUT3 (Output 3 @ 100mA MAX.)
4	IN3 (Input 3)	9	OUT4 (Output 4 @ 100mA MAX.)
5	IN4 (Input 4)	10	GND (Ground)



IMPORTANT! Install **J1** and **J2** to allow the 825 to supply (source) 12VDC to a solid-state relay or other load (100 mA maximum).

Figure No. 20



INSTALLATION, CONT.

I/O (Input/Output) Terminal Connections - External Power Source

Refer to the table and Figure No. 21 below to connect each wire to the terminal block.

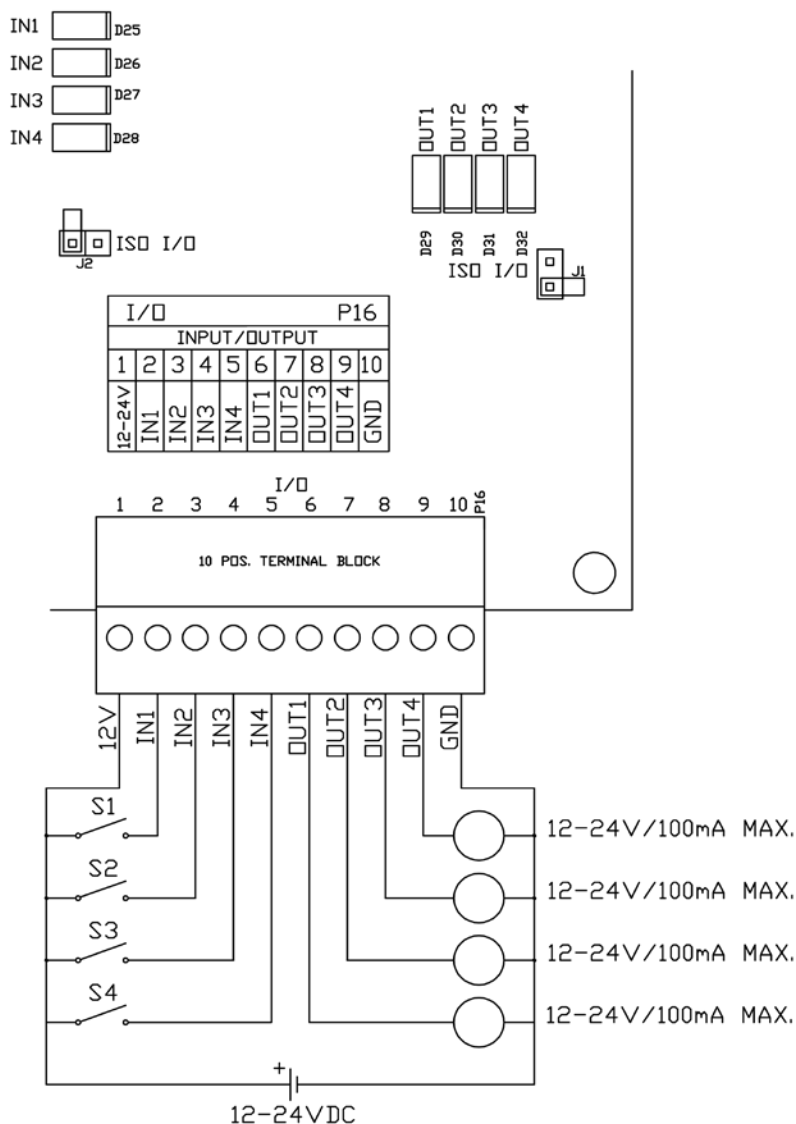
INPUT/OUTPUT - TERMINAL P16 (EXTERNAL POWER SOURCE)

Terminal	Function	Terminal	Function
1	12v (12 to 24VDC)	6	OUT1 (Output 1 @ 100mA MAX.)
2	IN1 (Input 1)	7	OUT2 (Output 2 @ 100mA MAX.)
3	IN2 (Input 2)	8	OUT3 (Output 3 @ 100mA MAX.)
4	IN3 (Input 3)	9	OUT4 (Output 4 @ 100mA MAX.)
5	IN4 (Input 4)	10	GND (Ground)



IMPORTANT! For completely isolated outputs (when using an external power source), remove **J1** and **J2** and connect 12 to 24VDC to P16 pin 1 and GND to P16 pin 10. Note that the load must still be 100 mA maximum.

Figure No. 21



MAIN PC BOARD



CAUTION! This board contains static-sensitive components. Improper handling can result in damage to or destruction of the components or board. Such actual and/or consequential damage IS NOT covered under the warranty.

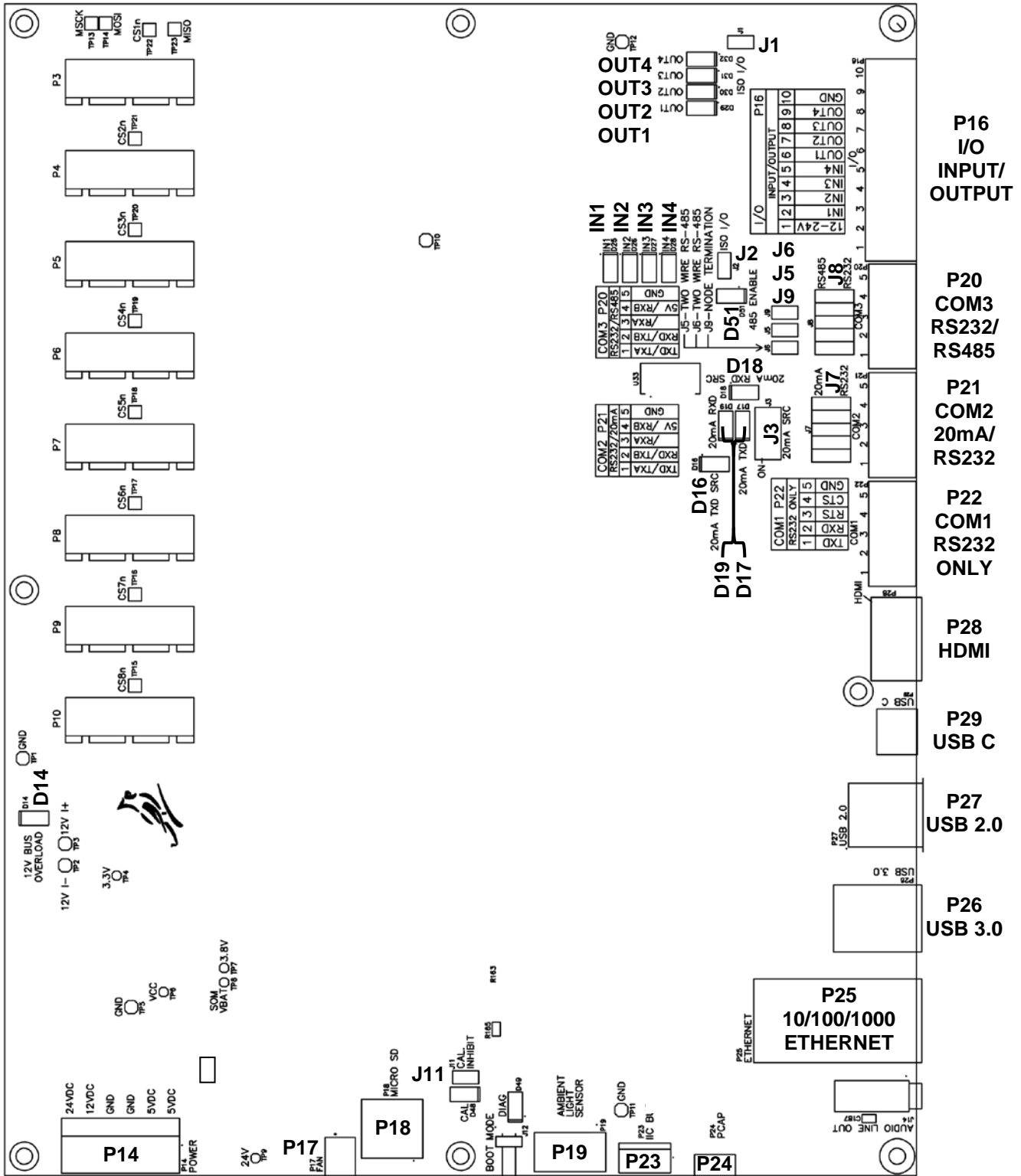


Figure No. 22

MAIN PC BOARD, CONT.

Jumpers

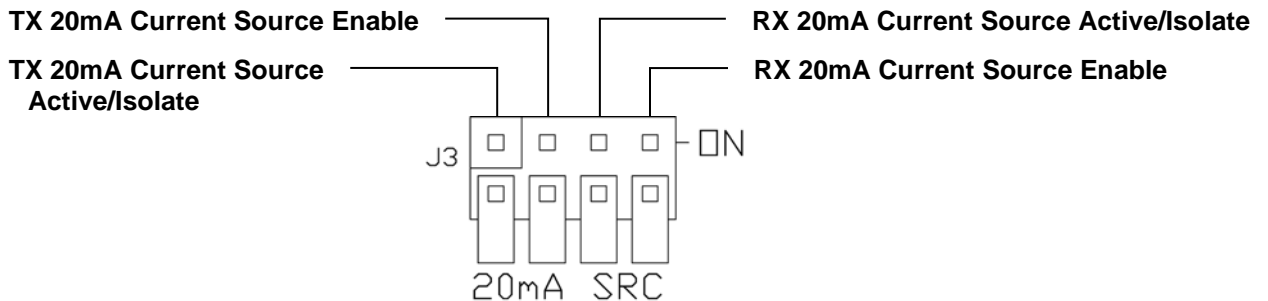
J1 and J2 - ISO I/O

When installed, these jumpers allow the 825 indicator to supply (source) 12VDC to a solid-state relay or other load (100 mA maximum).

To completely isolate the outputs when using an external power source, remove (or place on one pin only) J1 and J2. The external power source must provide 12 to 24 VDC to P16 pin 1 (12V) and a ground return to P16 pin 10 (GND). The load must still be 100 mA maximum.

J3 - 20mA SRC

This bank of 4 individual jumpers control the 20mA TXD and RXD current source and active/isolate status of P21 (COM2) when the J7 shunt has been installed to select the 20mA current loop serial protocol for P21 (COM2).

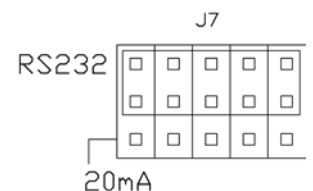


J5 and J6 - 2 WIRE RS-485 JUMPERS

These jumpers select RS-485 2-wire or 4-wire operation. When installed, the RS-485 operation is 2-wire (half duplex). To enable 4-wire (full duplex) operation, jumpers J5 and J6 must be open (on one pin only or removed).

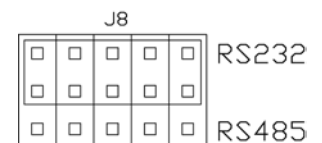
J7 - RS-232/20mA

This shunt (2x5-pin jumper) controls whether P21 (COM2) uses RS-232 or 20mA current loop serial protocol. When the shunt is installed on the center row of pins and the RS232 row of pins, the RS-232 serial protocol is used. To enable the 20mA current loop serial protocol for P21 (COM2) the shunt must be installed on the center row of pins and the 20mA row of pins.



J8 - RS-232/RS485

This shunt (2x5-pin jumper) controls whether P20 (COM3) uses RS-232 or RS-485 serial protocol. When the shunt is installed on the center row of pins and the RS232 row of pins, the RS-232 serial protocol is used. To enable the RS-485 serial protocol for P20 (COM3) the shunt must be installed on the center row of pins and the RS485 row of pins.



MAIN PC BOARD, CONT.

J9 - NODE TERMINATION

This jumper is for the RS-485 node termination selection. When installed, the RS-485 node is terminated indicating the 825 is the last device on the RS-485 bus. If the 825 is not the last device on the RS-485 bus (e.g., it is in the middle of the bus), then it must be un-terminated and jumper J9 must be open (on one pin only or removed).

J11 - CAL INHIBIT

This jumper is for the CAL INHIBIT selection. When installed, this jumper inhibits (prevents) calibration of the 825 indicator.

When removed, the word CAL will be shown in the lower right corner of the screen to indicate calibration is allowed and calibration of the 825 indicator can be performed.

Connectors

P3 = PCI Express connector for standard Scale Input Board (825-SIB).

P4 to P10 = PCI Express connectors for 825 option cards.

P14 = Power connector.

P15 = BDM connector (For Factory Use only).

P16 = I/O (Input/Output) 10 position terminal block.

P17 = FAN.

P18 = MicroSD (for programming only).

P19 = Ambient Light Sensor.

P20 = COM3 (RS-232/RS-485) 5 position terminal block.

P21 = COM2 (RS-232/20mA) 5 position terminal block.

P22 = COM1 (RS-232 only) 5 position terminal block.

P24 = Touchscreen USB interface cable

P25 = Ethernet Port 10/100/1000

P26 = 2X USB3.0 Host

P27 = USB2.0 Host

P28 = HDMI

P29 = USBC Dual Role Port

MAIN PC BOARD, CONT.

Status LED'S

- D14** = Turned on to indicate the 12 VDC supply exceeds 1.5A.
- D16** = Turned on to indicate the 20mA TXD SRC (transmit current source) is enabled.
- D17** = Turned on to indicate 20mA is present in the TXD (transmit) loop.
- D18** = Turned on to indicate the 20mA RXD SRC (receive current source) is enabled.
- D19** = Turned on to indicate 20mA is present in the RXD (receive) loop.
- D25** = Turned on to indicate that I/O Input 1 is active.
- D26** = Turned on to indicate that I/O Input 2 is active.
- D27** = Turned on to indicate that I/O Input 3 is active.
- D28** = Turned on to indicate that I/O Input 4 is active.
- D29** = Turned on to indicate that I/O Output 1 is active.
- D30** = Turned on to indicate that I/O Output 2 is active.
- D31** = Turned on to indicate that I/O Output 3 is active.
- D32** = Turned on to indicate that I/O Output 4 is active.
- D48** = Turned on to indicate Calibration can be accessed.
- D50** = Turned on to indicate board RESET.
- D51** = Turned on to indicate RS485 mode is enabled on COM3.

825-SIB (SCALE INPUT BOARD)

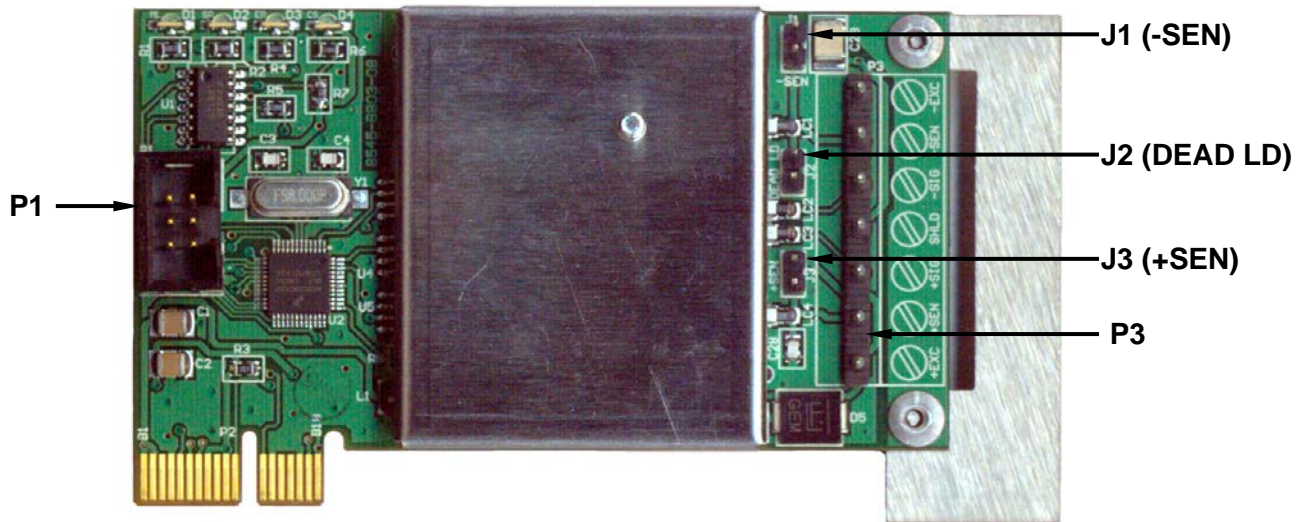


Figure No. 23

P1 - FACTORY USE ONLY

P3 - LOAD CELL TERMINAL

Board Label	Function	Board Label	Function
+EXC	+ EXCITATION	-SIG	- SIGNAL
+SEN	+ SENSE	-SEN	- SENSE
+SIG	+ SIGNAL	-EXC	- EXCITATION
SHLD	SHIELD		

J1 (-SEN) and J3 (+SEN) - SENSE JUMPERS

If the sense leads are NOT used, you must install the -SEN and +SEN jumpers at J1 and J3 (near the P3 terminal block). These jumpers connect the sense leads to the excitation leads. If sense leads ARE used (as in motor truck scales or installations with over 30 feet between the indicator and load cells), these jumpers should be open (on one pin only) or removed.

J2 (DEAD LD) - DEAD LOAD BOOST JUMPER

For scales with extremely low dead loads (less than 10% of the combined load cell capacity), connect the DEAD LD (dead load boost) jumper J2 (near the P3 terminal block).

CLOSING THE FRONT DISPLAY PANEL

After all terminations have been made.

1. Reinstall the 825-SIB into the enclosure and secure it to the main PC board with the screw removed earlier. See Figure No. 24.
2. Remove the excess cable from the base enclosure and securely tighten each of the cable gland connectors.
 - Do not overtighten these connectors but make certain they are snug.
 - **DO NOT USE TOOLS!** Finger-tighten only!
3. Ensure any unused gland connectors are plugged.
4. Next, close the hinged front display panel by lifting it until it is against the base enclosure.
5. Secure the front display panel to the base enclosure with the 2 thumbscrews removed earlier.

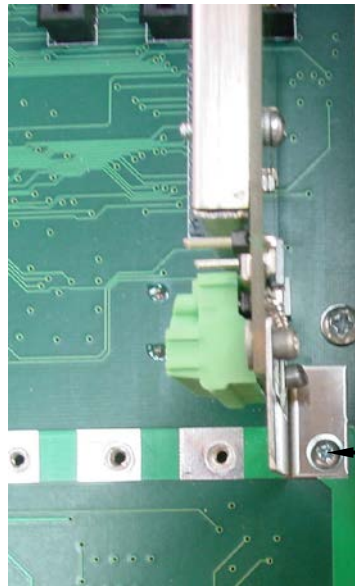


Figure No. 24

Secure 825-SIB to main board by installing this screw.

TOUCHSCREEN FUNCTIONS

The Model 825 Desktop Weight Indicator has an Interactive Touch Screen that will display a full Qwerty alphabet keyboard, a numeric keypad, and navigation keys with an **ENTER** key to be used to enter commands and data into the indicator during normal operations as well as during Calibration and Setup. Refer to the **Start-Up** screen, Figure No. 26, and the **Qwerty** screen, Figure No. 27, or the actual indicator while reading this section.



WARNING! The interactive touchscreen is not to be operated with pointed objects (pencils, pens, fingernails, etc.). Damage to the touch screen resulting from this practice is **NOT** covered under the warranty.

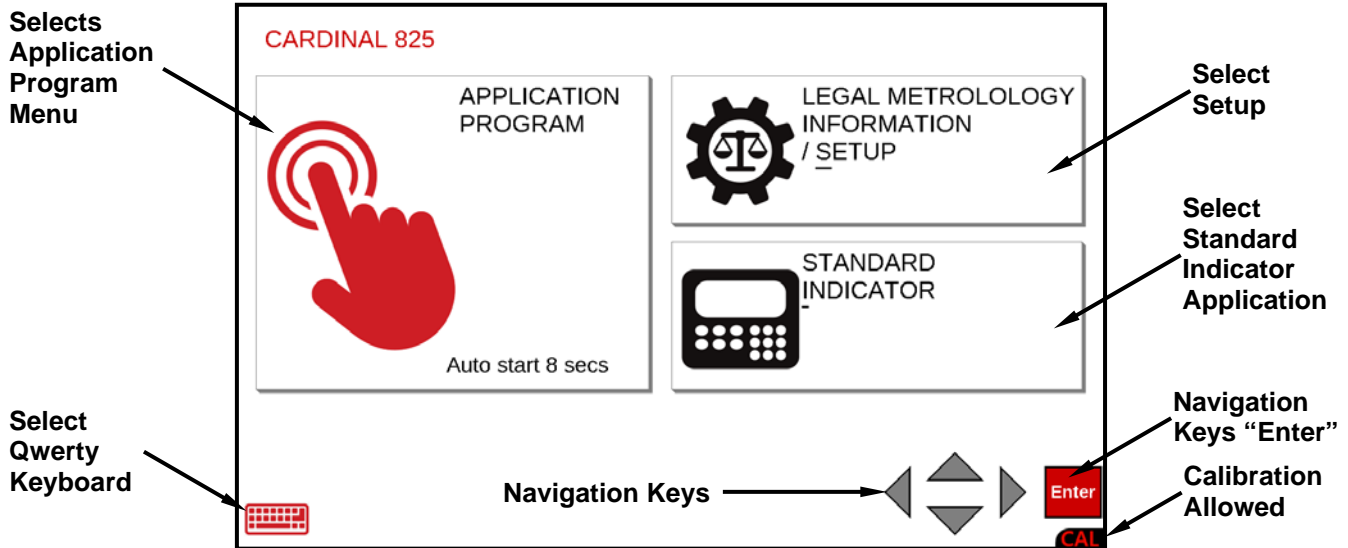


Figure No. 26

Selecting the Qwerty Keyboard will change the touchscreen to show the alphabet keyboard, the numeric keys, and a different view of the Navigation with **ENTER** keys. Note that the APPLICATION PROGRAM, LEGAL METROLOGY INFORMATION/SETUP, and STANDARD INDICATOR selections are the same as the **Start-Up** screen.

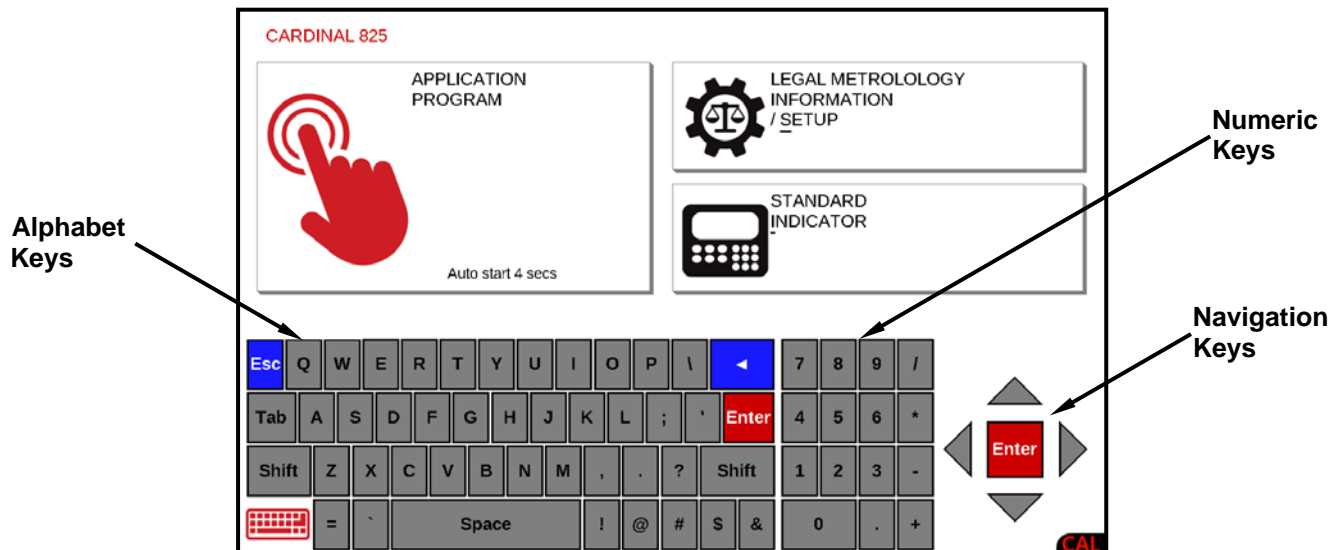


Figure No. 27

TOUCHSCREEN FUNCTIONS, CONT.

Navigation Keys

The Navigation Keys are used to move around and highlight the soft keys and menu selections configured by the STANDARD INDICATOR and APPLICATION PROGRAM selections. During setup and calibration, they are used to select (highlight) the parameter to change and to advance to the next parameter, back up to the previous parameter, or exit to the previous screen. Refer to Figures No. 22 and 23 or the actual indicator while reading this section.



Press the Down Arrow key to move “down” to highlight the selection.



Press the UP Arrow key to move “up” to highlight the selection.



Press the Left Arrow key to move “left” to highlight the selection.



Press the Right Arrow key to move “right” to highlight the selection.

ENTER

The Navigation Keys **ENTER** key is used to select and perform the function of a highlighted soft key or menu selection.

Note that this key and the alphabet **ENTER** key perform the same functions. Either key can be used when entering or changing data to signal the completion of data entry and process the data entered. During normal operations (as well as Calibration and Setup), pressing the key will retain the current settings displayed and advance to the next setup parameter or setup screen.

Qwerty Keyboard

This section describes the qwerty keyboard along with any special functions they have. The alphabet and numeric keys are used to enter commands and data into the indicator during normal operations as well as during Calibration and Setup.

Alphabet Keys

These keys are used to enter alphabetical characters during Calibration and Setup as well as during normal operations.

Numeric Keys (1 to 9 and 0)

These keys are used to enter numeric data during the setup and calibration as well as during the normal operation of the indicator. Note that they have alternate meanings. See the **SHIFT** key.

TOUCHSCREEN FUNCTIONS, CONT.


Qwerty Keyboard, Cont.

SHIFT

Pressing this key before pressing an alphabet or numeric key will cause the key to output its alternate meaning.

When combined with the alphabet keys, the **SHIFT** key causes a lowercase (not a capital letter) to be output. For example, pressing the **SHIFT** key then the **A** key will output a lowercase "a" (not a capital letter).

(BACKSPACE)

When entering data (either during setup and calibration or during normal operation) pressing this key will delete (backspace) the last character entered. If more than the last character is incorrect, press the  (**BACKSPACE**) key for each character to be deleted. Note that the indicator will ignore pressing this key if no characters have been entered.

Esc

Pressing this key will "escape" (return or backup) to the previous screen.

ENTER

The **ENTER** key is used when entering or changing data to signal the completion of data entry and process the data entered. During normal operations (as well as Calibration and Setup), pressing the key will retain the current settings for the parameters displayed and advance to the next screen.

Note that this key and the Navigation Keys **ENTER** key perform the same functions. Either key can be used to select and perform the function of a highlighted soft key or menu selection.

SPACE

This key is used to enter a blank space during alphanumeric data input for setup and calibration as well as during normal operations. In addition, some parameters in setup and calibration require pressing the **SPACE** key to toggle its status or to step through the available selections.

TOUCHSCREEN FUNCTIONS, CONT.

Standard Indicator Keys

This section describes the Standard Indicator keys displayed on the weight screen along with their functions as programmed by the STANDARD INDICATOR selection on the **Start-Up** screen. Refer to Figure No. 28 or the actual indicator screen while reading this section.

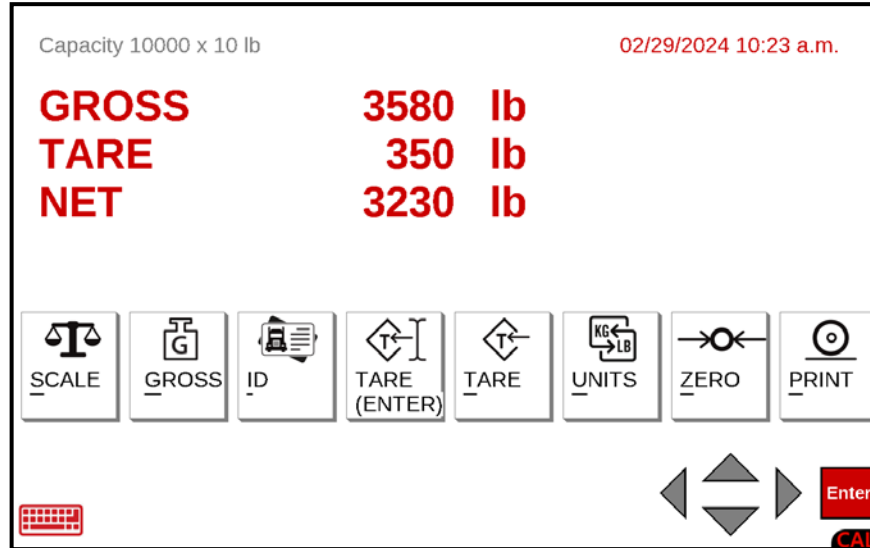


Figure No. 28

SCALE

Pressing the **SCALE** key (with multiple scales) will toggle through the available scales and, if enabled, the totalizer. Note that by pressing this key with only one scale, the key press will be ignored.

NET/GROSS

Pressing the **NET** key (if in Gross mode) or the **GROSS** key (if in Net mode) will toggle between the Gross weight and Net weight. In the Gross weight mode, the total of all weight placed on the scale since the display was zeroed is displayed. In the Net weight mode, the Gross, Tare, and Net weight are displayed.

NOTE: If a valid tare weight has not been entered, pressing this key will momentarily display the message:

Cannot show net - tare zero

The display will return to the weight screen, showing gross weight only

TOUCHSCREEN FUNCTIONS, CONT.

Standard Indicator Keys, Cont.

ID

This key allows the operator to enter an ID (identification) for use in printing

1. Press the **I**D key.
2. The display will change to show the **Set ID** screen.
3. Using the alpha and numeric keys, enter up to a ten (10) character ID and press the **ENTER** key to save it.
4. The display will return to the weight screen.

NOTE: Once an ID has been entered, it will remain until another ID is entered or it is cleared.

1. To clear an ID, first press the **I**D key.
2. With the **Set ID** screen displayed, press the **SPACE** key and then the **ENTER** key.
3. The display will return to the weight screen.

TARE (ENTER)

This key allows the operator to enter a tare weight (up to the capacity of the scale). Note that the tare weight is the amount of weight to be subtracted from the gross weight to obtain the net weight.

1. Press the **TARE (ENTER)** key.
2. The display will change to show the **Set Tare** screen.
3. Using the numeric keys (use the period for the decimal point), enter the tare weight and press the **ENTER** key.
4. The display will return to the weight screen, showing the Gross, Tare, and Net weights.

NOTE: The tare weight will remain until another tare weight is entered or it is cleared. Clearing the tare weight can only be performed when zero weight is on the scale.

1. With the zero weight on the scale, press the **TARE** key.
2. The display will return to the weight screen, showing gross weight only.

TARE (Pushbutton Tare)

Pressing the **TARE** key will act as a pushbutton tare and will store the current Gross weight as the new tare weight and will switch the display to the Net weight mode.

UNITS

Pressing the **UNITS** key will change the weighing units to the alternate units if available. For example, with lb (pounds) showing, pressing this key will change the weight units to kg (kilograms).

NOTE: This feature must be enabled during setup and calibration (see the Base Units and Conv Units parameters).

TOUCHSCREEN FUNCTIONS, CONT.

Standard Indicator Keys, Cont.

ZERO

Pressing the **ZERO** key allows the operator to reset the Gross weight to zero.

NOTE: If the gross weight exceeds the zero limit for this key, pressing this key will momentarily display the message:

CANNOT ZERO -

The display will return to the weight screen, showing gross weight only

Note that the zero limit may be either 4% or 100% of the scale capacity. This limit is set during setup and calibration (see the Zero Limit parameter).

PRINT

Pressing the **PRINT** key will initiate the transmission of weight data to the ticket printer. If displaying Gross weight, the time, date, and gross weight are printed. If displaying net weight, the time, date, gross, tare, and net weights are printed.

NOTE: If the weight is less than zero (negative weight), pressing this key will momentarily display the message:

Cannot print BELOW ZERO -

The display will return to the weight screen, showing gross weight only.

NOTE: If the weight is unstable (motion on the scale), pressing this key will momentarily display the message:

Cannot print MOTION -

The display will return to the weight screen, showing gross weight only

TOUCHSCREEN FUNCTIONS, CONT.

Application Program Keys

This section describes the various touch screen keys displayed on the screen along with their functions as programmed by the included APPLICATION PROGRAM selection on the **Start-Up** screen. Refer to Figure No. 29 or the actual indicator screen for the included applications.

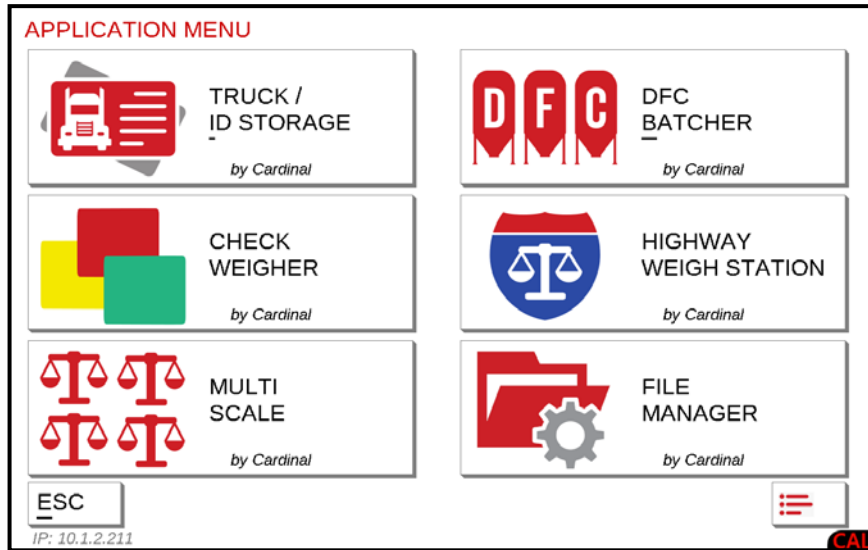


Figure No. 29



NOTE: The following describes the keys that are displayed on the screen and their functions as programmed for the TRUCK / ID STORAGE, CHECK WEIGHER, MULTI SCALE, DFC BATCHER, and HIGHWAY WEIGH STATION applications.

MENU

Pressing this key will change the screen to display the menu selections for the application. The menu selection allows setting the date and time, configuring parameters for the application, and inputting various data used by the application.

ZERO

Pressing the **ZERO** key allows the operator to reset the Gross weight to zero.

NOTE: If the gross weight exceeds the zero limit for this key, pressing this key will momentarily display the message:

CANNOT ZERO -

The display will return to the weight screen, showing gross weight only

Note that the zero limit may be either 4% or 100% of the scale capacity. This limit is set during setup and calibration (see the Zero Limit parameter).

TOUCHSCREEN FUNCTIONS, CONT.

Application Program Keys, Cont.

UNITS

Pressing the **UNITS** key will change the weighing units to the alternate units if available. For example, with lb (pounds) showing, pressing this key will change the weight units to kg (kilograms).

NOTE: This feature must be enabled during setup and calibration (see the Base Units and Conv Units parameters).

TARE (ENTER)

This key allows the operator to enter a tare weight (up to the capacity of the scale). Note that the tare weight is the amount of weight to be subtracted from the gross weight to obtain the net weight.

1. Press the **TARE (ENTER)** key.
2. The display will change to show the **Set Tare** screen.
3. Using the numeric keys (use the period for the decimal point), enter the tare weight and press the **ENTER** key.
4. The display will return to the weight screen, showing the Gross, Tare, and Net weights.

NOTE: The tare weight will remain until another tare weight is entered or it is cleared. Clearing the tare weight can only be performed when zero weight is on the scale.

1. With the zero weight on the scale, press the **TARE** key.
2. The display will return to the weight screen, showing gross weight only.

TARE (Pushbutton Tare)

Pressing the **TARE** key will act as a pushbutton tare and will store the current Gross weight as the new tare weight and will switch the display to the Net weight mode.

NET/GROSS

Pressing the **NET** key (if in Gross mode) or the **GROSS** key (if in Net mode) will toggle between the Gross weight and Net weight. In the Gross weight mode, the total of all weight placed on the scale since the display was zeroed is displayed. In the Net weight mode, the Gross, Tare, and Net weight are displayed.

NOTE: If a valid tare weight has not been entered, pressing this key will momentarily display the message:

Cannot show net - tare zero

The display will return to the weight screen, showing gross weight only

TOUCHSCREEN FUNCTIONS, CONT.

Application Program Keys, Cont.

ID

This key allows the operator to enter an ID (identification) for use in printing

1. Press the **ID** key.
2. The display will change to show the **Set ID** screen.
3. Using the alpha and numeric keys, enter up to a ten (10) character ID and press the **ENTER** key to save it.
4. The display will return to the weight screen.

NOTE: Once an ID has been entered, it will remain until another ID is entered or it is cleared.

1. To clear an ID, first press the **ID** key.
2. With the **Set ID** screen displayed, press the **SPACE** key and then the **ENTER** key.
3. The display will return to the weight screen.

PRINT

Pressing the **PRINT** key will initiate the transmission of weight data to the ticket printer. If displaying Gross weight, the time, date, and gross weight are printed. If displaying net weight, the time, date, gross, tare, and net weights are printed.

NOTE: If the weight is less than zero (negative weight), pressing this key will momentarily display the message:

Cannot print BELOW ZERO -

The display will return to the weight screen, showing gross weight only.

NOTE: If the weight is unstable (motion on the scale), pressing this key will momentarily display the message:

Cannot print MOTION -

The display will return to the weight screen, showing gross weight only

ANNUNCIATORS

The annunciators are displayed on the weight screen to show that the 825 is in the mode corresponding to the annunciator label or that the status indicated by the label is active.

CENTER ZERO

This is shown on the weight screen to indicate that the displayed (zero) weight is within +/- 1/4 division of the center of zero.

GROSS

This is shown on the weight screen to indicate that the 825 is in the Gross weight mode.

NET

This is shown on the weight screen when the 825 is in the Net weight mode. Note that the screen will display the Gross, Tare, and Net weights.

TARE

This is shown on the weight screen to indicate that a Tare weight has been stored. Note that the Gross and Net weights will be displayed also.

tn

This is displayed on the weight screen to show that the weight units are avoirdupois tons.

lb

This is displayed on the weight screen to show that the weight unit is pounds.

t

This is displayed on the weight screen to show that the weight units are tonnes (metric tons).

kg

This is displayed on the weight screen to show that the weight units are kilograms.

SETUP

Your 825 indicator has been thoroughly tested and calibrated before being shipped to you. If you received the indicator attached to a scale, calibration is not necessary. If the indicator is being connected to a scale for the first time or recalibration is necessary for other reasons, proceed as indicated.

Setup and Calibration of the indicator is accomplished entirely by using the touchscreen display. However, it may require changing the position of the calibration jumper depending on the method of sealing required by your local metrology laws.

Calibration Jumper (J11 - CAL INHIBIT)

The calibration jumper J11 (CAL INHIBIT) is located on the edge of the 825 circuit board and can **only** be accessed by lowering the front panel of the indicator. See Figure No. 22 for the location of the calibration jumper. Refer to the table below and Figure No. 22 for the jumper settings.

When the calibration jumper is removed (off or on one pin), the word CAL will be shown in the lower right corner of the screen to indicate calibration is allowed and that calibration of the 825 can be performed.

NOTE: On an indicator with the jumper in this position, the Category 1 event counter security seal is used as the sealing method.

When the calibration jumper is installed (on both pins), the word CAL will NOT be shown in the lower right corner of the screen, and calibration is NOT permitted.

NOTE: With the jumper on (installed), the calibration screens are “read-only” and when the calibration mode is selected, the indicator will display:

Calibration locked by hardware jumper inside enclosure

On an indicator with the jumper in this position and a lock-wire seal, you cannot perform the calibration unless you break the lock-wire security seal to access the calibration jumper and remove it to enable the hardware calibration. Refer to the table below:

Table of Calibration Switch Settings

Calibration Jumper Position	Sealing Method Used	Calibration Enabled?	Display when calibration mode is accessed
OFF	Category 1 Event Counters	Yes	Calibration is allowed
ON	Category 1 Lock-Wire Seal	No	Calibration is <u>not</u> allowed.

SETUP, CONT.

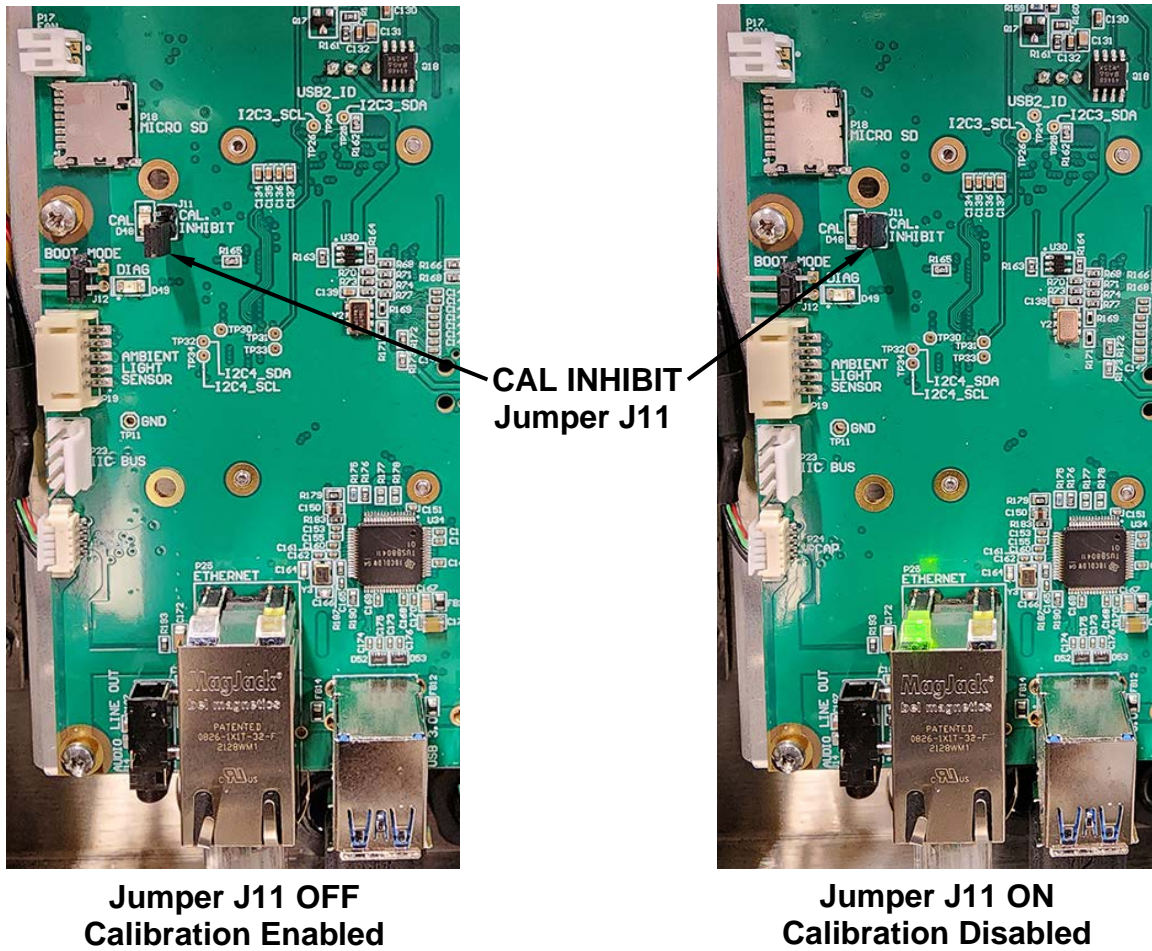


Figure No. 30



NOTE: With the calibration jumper removed (or on one pin), the CAL LED D48 will be illuminated when the 825 is powered on. In the left image above, the 825 was powered off to clearly show that jumper J11 has been removed and is on one pin.

If you attempt calibration with the J11 jumper installed, by performing the following steps:

1. Selecting LEGAL METROLOGY INFORMATION / SETUP on the Start-Up screen,
2. Selecting Setup Menu on the Legal metrology information / Setup screen
3. Entering your login on the Login screen,
4. Selecting Calibration on the Setup Menu screen,
5. Selecting 1. Scale 1 on the Setup Scale Number screen,

The screen will change to the Scale 1 Calibration Options with the following message shown:

Calibration locked by hardware jumper inside enclosure

SETUP, CONT.



WARNING! The interactive touchscreen is not to be operated with pointed objects (pencils, pens, fingernails, etc.). Damage to the touch screen resulting from this practice is **NOT** covered under the warranty.

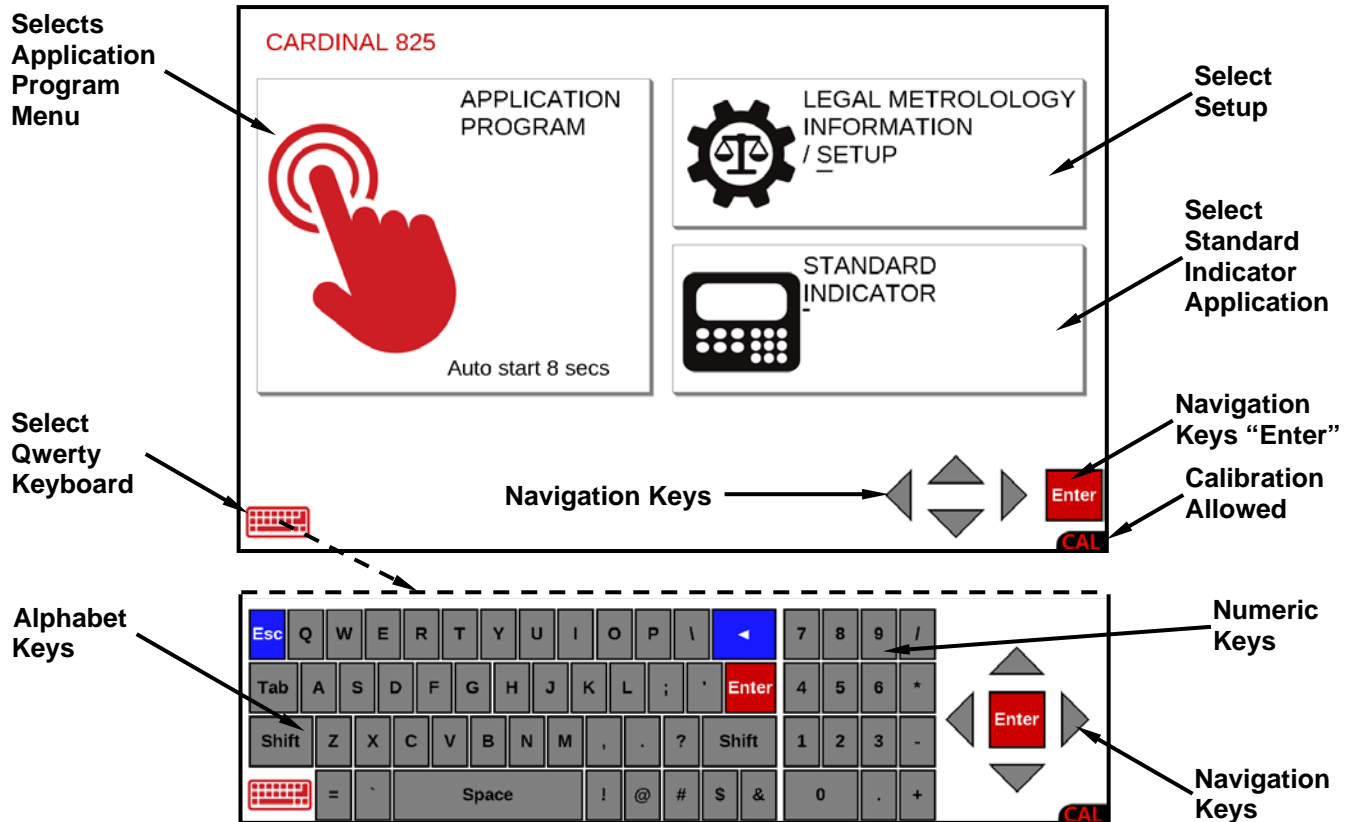


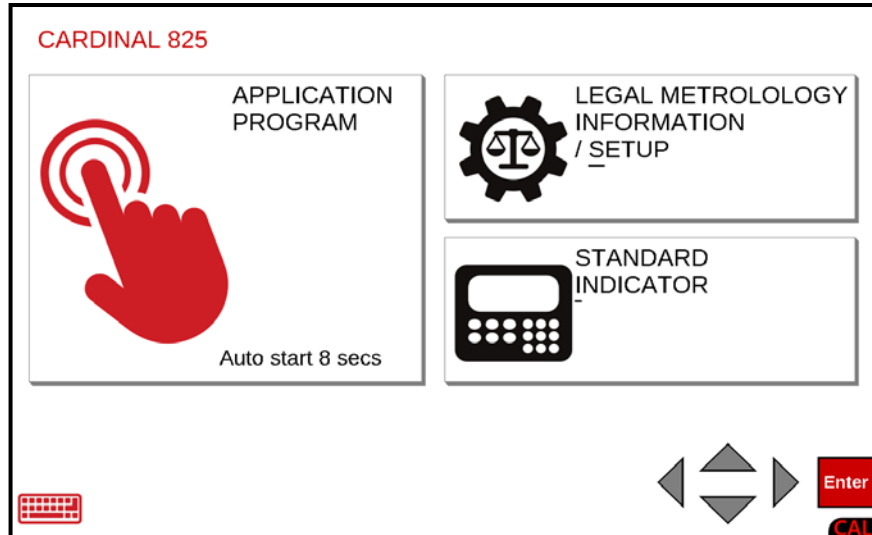
Figure No. 31

- Use the Navigation Keys to select (highlight) the parameter to change or press the underlined letter or number key corresponding to the parameter to change.
- Press the Navigation Keys ▼ Down Arrow to “advance” to the next parameter selection.
- Press the Navigation Keys ▲ UP Arrow to “back up” to the previous parameter selection.
- Press the Navigation Keys ► Right Arrow to “advance” to the next parameter column.
- Press the Navigation Keys ◀ Left Arrow to “exit” to the previous screen.
- Press the **Esc** key to “escape” (return or backup) to the previous screen.
- Pressing the Qwerty keyboard or Navigation Keys **ENTER** key without entering a new value will retain the current setting and return to the previous screen.
- Use the Qwerty keyboard to enter new values for parameters requiring data input.
- Some parameters require pressing the **SPACE** key to toggle its status or to step through the available selections.
- After entering (or selecting) a new value, press the Navigation Keys ▼ Down Arrow to advance to the next parameter or press the **ENTER** key to save the new setting and return to the previous screen.
- Press the **◀ (BACKSPACE)** key to delete an incorrect value or character entered.

SETUP, CONT.

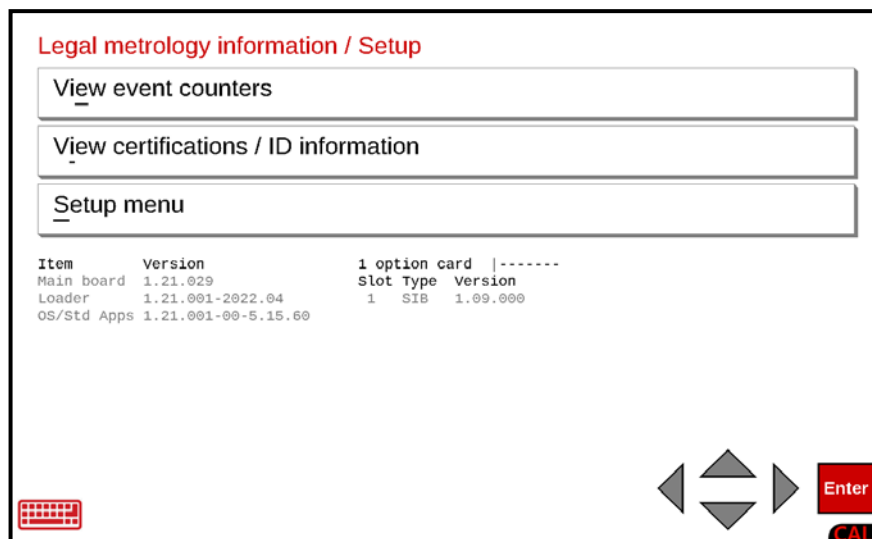
To Begin Setup

1. Press the Push Button Power Switch on the rear enclosure (see Figure No. 2) of the 825 to turn it on. The display will perform a short self-test and then change to the **Start-Up** screen.



NOTE: When the 825 is initially started, an Auto-start countdown beginning at 8 seconds will appear on the APPLICATION PROGRAM selection. When the countdown is complete, the application program mode will automatically start.

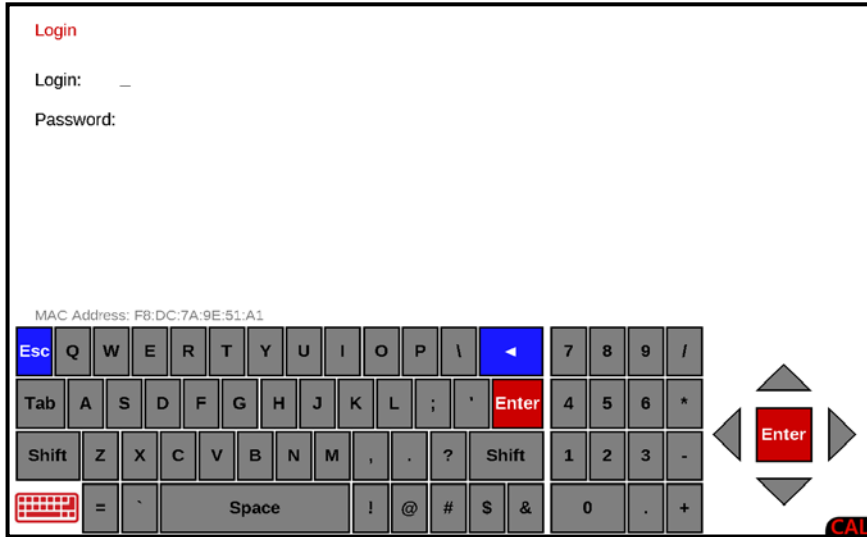
2. With the **Start-Up** screen displayed, press the LEGAL METROLOGY INFORMATION / SETUP selection on the touchscreen or use the Qwerty keyboard and press the **S** key to select LEGAL METROLOGY INFORMATION / SETUP or use the Navigation Keys ► Right Arrow to (highlight) the selection and press the **ENTER** key.
3. The display will change to show the **Legal metrology information / Setup** screen.



NOTE: The lower portion of this screen shows the software versions of the main board and option cards installed as well as a representation of the slot the option card is installed in.

SETUP, CONT.

With the **Legal metrology information / Setup** screen displayed, press the Navigation Keys **▼** Down Arrow to (highlight) the Setup menu option and press the **ENTER** key or use the Qwerty keyboard and press the **S** key to select the Setup menu option. The display will change to show the **Login** screen and prompt for the Login and Password.

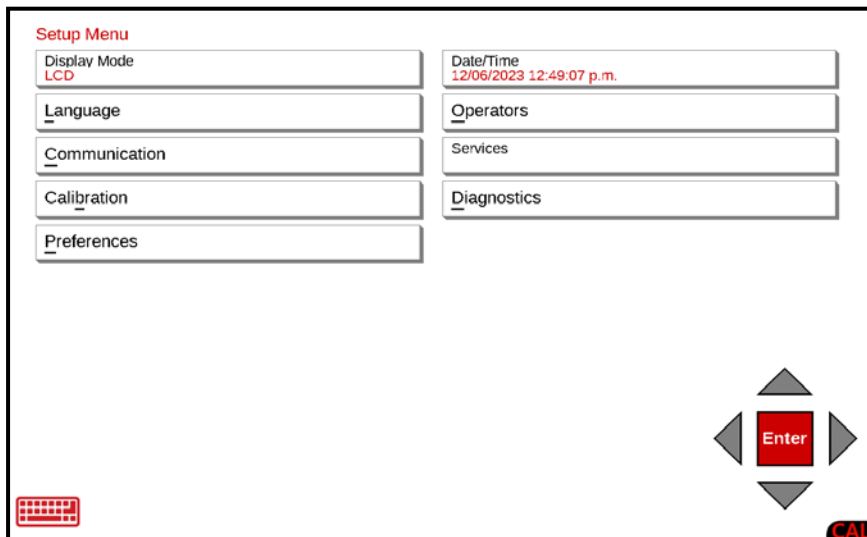


1. With the **Login** screen and prompt displayed, use the Qwerty keyboard to enter the login and press the **▼** Down Arrow to advance to the password prompt.
2. Enter the password using the numeric keys and press the **ENTER** key to proceed with Setup.



NOTE: The 825 will arrive from the factory with the calibration access locked by the “login” and “password” prompts protection. The factory default login and password are “ADMIN” and “81440”.

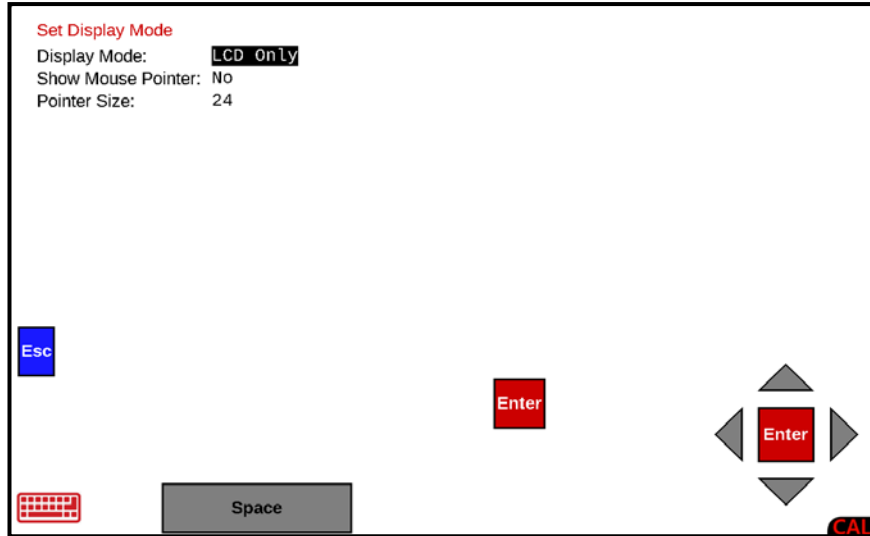
3. After logging in, the display will change to the **Setup Menu** screen.



SETUP, CONT.

Display Mode

With the **Setup Menu** screen displayed, press the Display Mode menu option, or use the Qwerty keyboard and press the **M** key to select Display Mode, or use the Navigation Keys to select (highlight) Display Mode and press the **ENTER** key. The display will change to show the **Set Display Mode** screen.



Display Mode:

With the **Set Display Mode** screen displayed the current setting for the Display Mode: parameter will be shown. If the setting displayed is acceptable, press the ▼ Down Arrow to proceed to the next parameter or press the **ENTER** key to return to the Setup Menu.

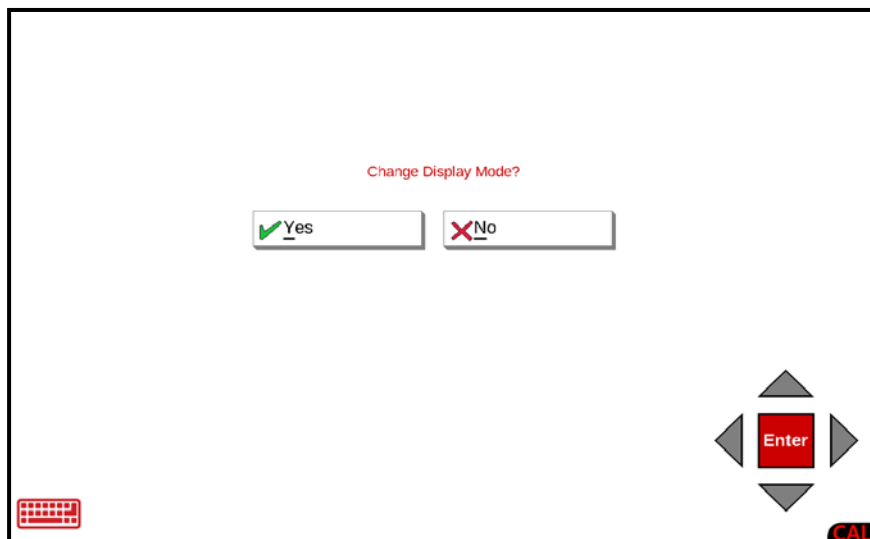
If the current setting is not acceptable, press the **SPACE** key to step through and select the display mode, and press the **ENTER** key. Available display modes are:

LCD Only

HDMI Only

LCD and HDMI

After selecting the display mode and pressing the **ENTER** key, the screen will change to show a **Change Display Mode?** confirmation screen.



SETUP, CONT.

Display Mode, Cont.

With the **Change Display Mode?** confirmation screen displayed, press the Yes or No option on the screen, or use the Qwerty keyboard and press the **Y** or **N** key, or use the Navigation Keys to select (highlight) Yes or No and press the **ENTER** key.

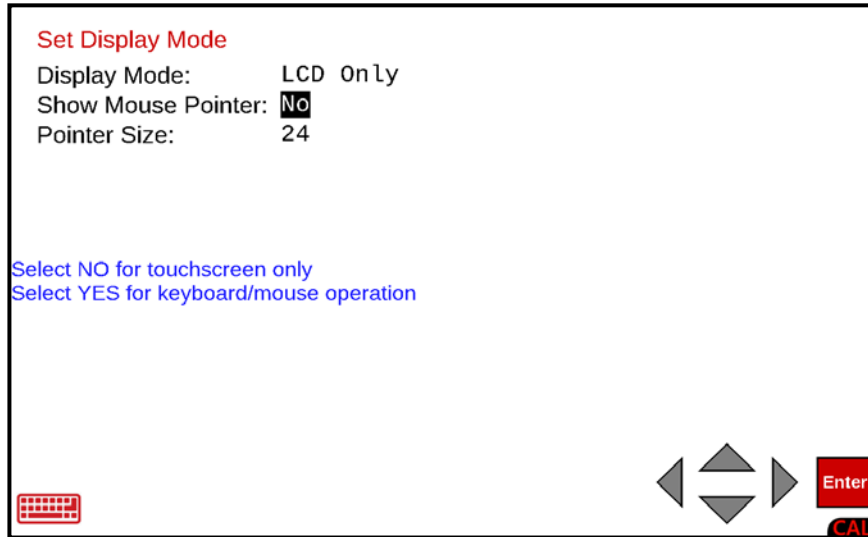
- If No is selected, the display will return to the **Setup Menu** screen.
- If Yes is selected, the display will change to show (in the middle of the screen)

Shutting down... Cycle Power after shutdown is complete

and then blank the display of the indicator. Press the push button power switch to turn the indicator completely off and then press it again to turn the indicator back on

Show Mouse Pointer:

With the **Set Display Mode** screen displayed the current setting for the Show Mouse Pointer: parameter will be shown. If the setting displayed is acceptable, press the ▼ Down Arrow to proceed to the next parameter or press the **ENTER** key to return to the Setup Menu.



If the current setting is not acceptable, press the **SPACE** key to toggle the setting between Yes and No.

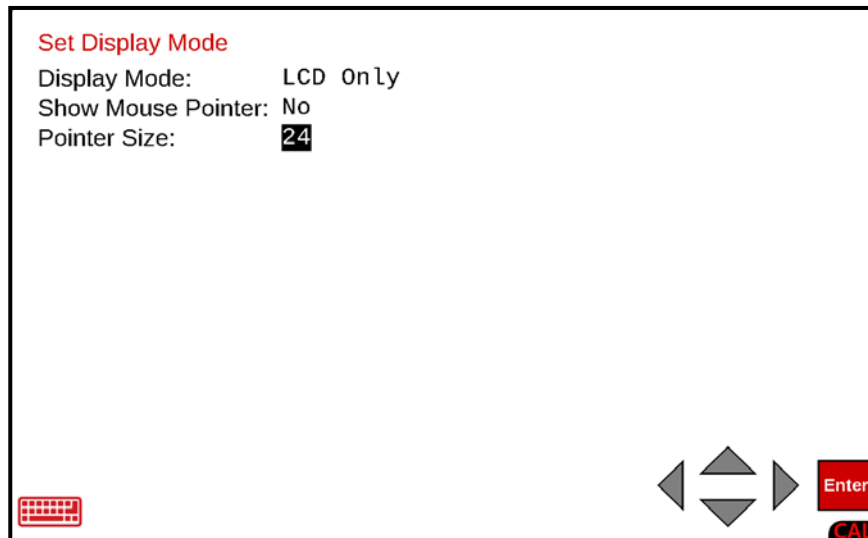
- Select Yes to show the mouse pointer when using a keyboard/mouse and press the **ENTER** key to return to the **Setup Menu** screen.
- Select No when using the Touchscreen Only and press the **ENTER** key to return to the **Setup**

SETUP, CONT.

Pointer Size:

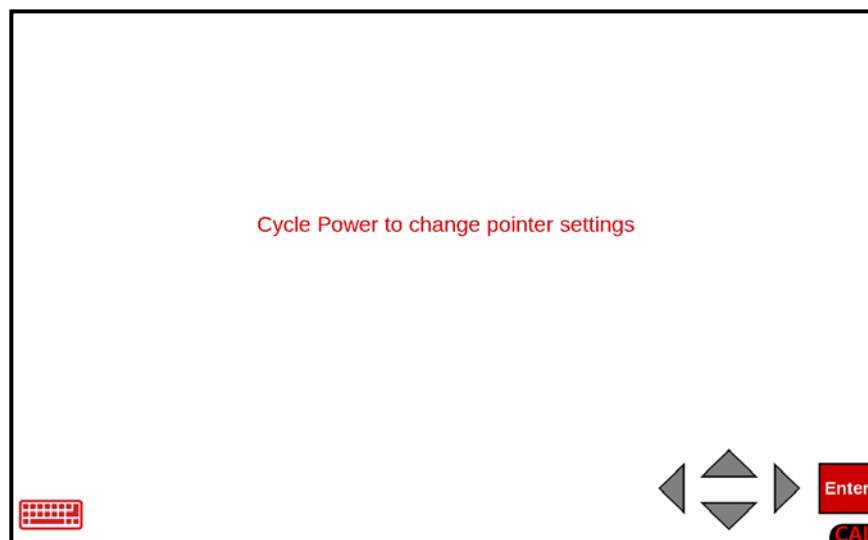
With the **Setup Menu** screen displayed, press the Display Mode menu option, or use the Navigation Keys to select (highlight) Display Mode and press the **ENTER** key. The display will change to show the **Set Display Mode** screen.

The current setting for the Show Mouse Pointer: parameter will be shown. If the setting displayed is acceptable, press the **ENTER** key to return to the Setup Menu.



If the current setting is not acceptable, use the numeric keys to enter a new mouse pointer size and press the **ENTER** key. Available mouse pointer sizes are 8 to 60.

After selecting a new mouse pointer size, the display will change to show **Cycle Power to change pointer settings** in the middle of the screen.

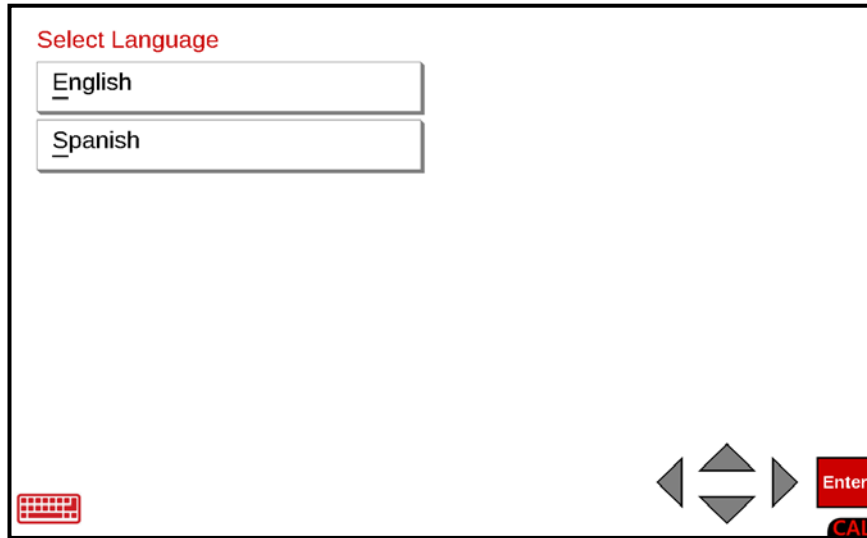


Press the push button power switch to turn the indicator off and then then press it again to turn the indicator back on. The indicator will now have the new mouse pointer size.

SETUP, CONT.

Language

With the **Setup Menu** screen displayed, press the Language menu option, or use the Qwerty keyboard and press the **L** key to select Language, or use the Navigation Keys to select (highlight) Language and press the **ENTER** key. The display will change to show the **Select Language** screen.



With the **Select Language** screen displayed, perform one of the following to select the language for the indicator displays:

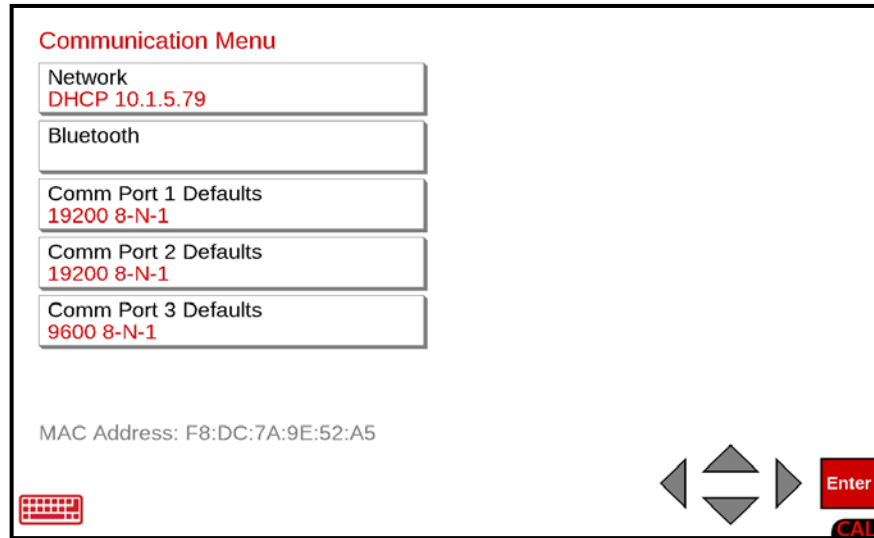
- Press the language selection English, or Spanish on the touchscreen.
- Use the Qwerty keyboard and press the **E** or **S** key to select the language.
- Use the Navigation Keys to select (highlight) the language and press the **ENTER** key.

After selecting the language, the display will return to the Setup Menu.

SETUP, CONT.

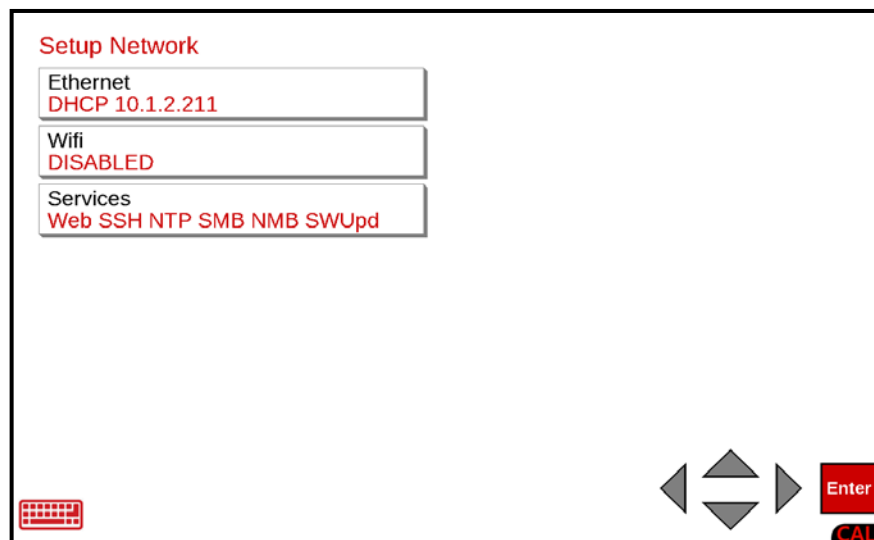
Communication

With the **Setup Menu** screen displayed, press the Communication menu option, or use the Qwerty keyboard and press the **C** key to select Communication, or use the Navigation Keys to select (highlight) Communication and press the **ENTER** key. The display will change to show the **Communication Menu** screen.



Network

With the **Communication Menu** screen displayed, press the Network menu option, or use the Qwerty keyboard and press the **N** key to select Network, or use the Navigation Keys to select (highlight) Network and press the **ENTER** key. The display will change to show the **Setup Network** screen.



Ethernet

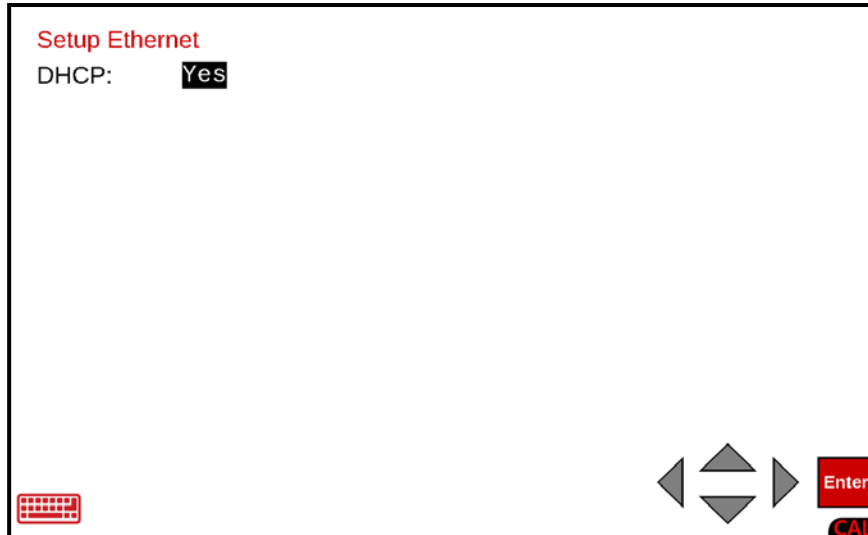
With the **Setup Network** screen displayed, press the Ethernet menu option, or use the Qwerty keyboard and press the **E** key to select Ethernet, or use the Navigation Keys to select (highlight) Ethernet and press the **ENTER** key. The display will change to show the **Setup Ethernet** screen.

SETUP, CONT.

Setup Ethernet

DHCP:

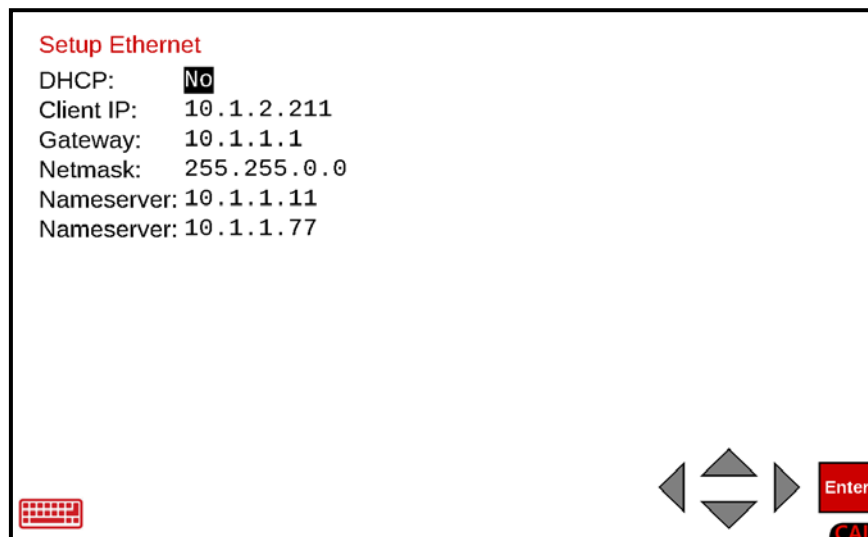
With the **Setup Ethernet** screen displayed the current setting for the DHCP: parameter will be shown. If the setting displayed is acceptable press the **ENTER** key to return to the **Setup Network** screen.



If the current setting is not acceptable, press the **SPACE** key to toggle the setting between Yes and No.

- Select Yes (for automatic IP assignment from a DHCP server connected to your network) and press the **ENTER** key to return to the **Setup Network** screen. Next press the Navigation Keys ◀ Left Arrow or use the Qwerty keyboard **Esc** key to return to the **Communication Menu** screen.
- Select No (to allow manual entry of the Client IP, Gateway, Netmask, and Nameserver values) and press the ▼ Down Arrow to advance to the next parameter.

NOTE: When No is selected for DHCP:, there are additional parameters shown on the **Setup Ethernet** screen that require data to be entered.



SETUP, CONT.

Setup Ethernet, Cont.



NOTE: The following additional parameters will be shown on the **Setup Ethernet** screen when No is selected for DHCP:.

Client IP:

With No selected for DHCP: the current setting for Client IP: will be shown. If the setting displayed is acceptable, press the ▼ Down Arrow to advance to the next parameter or press the **ENTER** key to return to the **Setup Network** screen.

If the current setting is not acceptable, use the numeric keys (and the period key) to enter the IP address for this indicator and press the ▼ Down Arrow to advance to the next parameter or press the **ENTER** key to save the new setting and return to the **Setup Network** screen.

NOTE: The format for the Client IP address is ## . # . # . ## (e.g., 10.1.2.211).



IMPORTANT! No other device on the network should have this IP address.

Gateway:

With No selected for DHCP: the current setting for Gateway: will be shown. If the setting displayed is acceptable, press the ▼ Down Arrow to advance to the next parameter or press the **ENTER** key to return to the **Setup Network** screen.

If the current setting is not acceptable, use the numeric keys (and the period key) to enter the gateway address and press the ▼ Down Arrow to advance to the next parameter, or press the **ENTER** key to save the new setting and return to the **Setup Network** screen.

NOTE: The format for the gateway address is # . # . # . # (e.g., 10.1.1.1).

Netmask:

With No selected for DHCP: the current setting for Netmask: will be shown. If the setting displayed is acceptable, press the ▼ Down Arrow to advance to the next parameter or press the **ENTER** key to return to the **Setup Network** screen.

If the current setting is not acceptable, use the numeric keys (and the period key) to enter the Netmask and press the ▼ Down Arrow to advance to the next parameter, or press the **ENTER** key to save the new setting and return to the **Setup Network** screen.



IMPORTANT! The Netmask of the indicator should match the Netmask of the other computers on your network. The format for the Netmask is ### . ### . ### . # (e.g., 255.255.0.0).

SETUP, CONT.

Setup Ethernet, Cont.

Nameserver:

With No selected for DHCP: the current setting for Nameserver: will be shown. If the setting displayed is acceptable, press the ▼ Down Arrow to advance to the next parameter or press the **ENTER** key to return to the **Setup Network** screen.

If the current setting is not acceptable, use the numeric keys (and the period key) to enter the address of a Nameserver to translate names into IP addresses and press the ▼ Down Arrow to advance to the next parameter or press the **ENTER** key to save the new setting and return to the **Setup Network** screen.

NOTE: The format for the Nameserver is ## . # . # . # (e.g., 10.1.1.11).

Nameserver:

With No selected for DHCP: the current setting for a second Nameserver: will be shown. If the setting displayed is acceptable, press the **ENTER** key to return to the **Setup Network** screen.

If the current setting is not acceptable, use the numeric keys (and the period key) to enter the address of a second Nameserver to translate names into IP addresses and press the **ENTER** key to save the new setting, and return to the **Setup Network** screen.

NOTE: The format for the Nameserver is ## . # . # . # (e.g.,10.1.1.77).

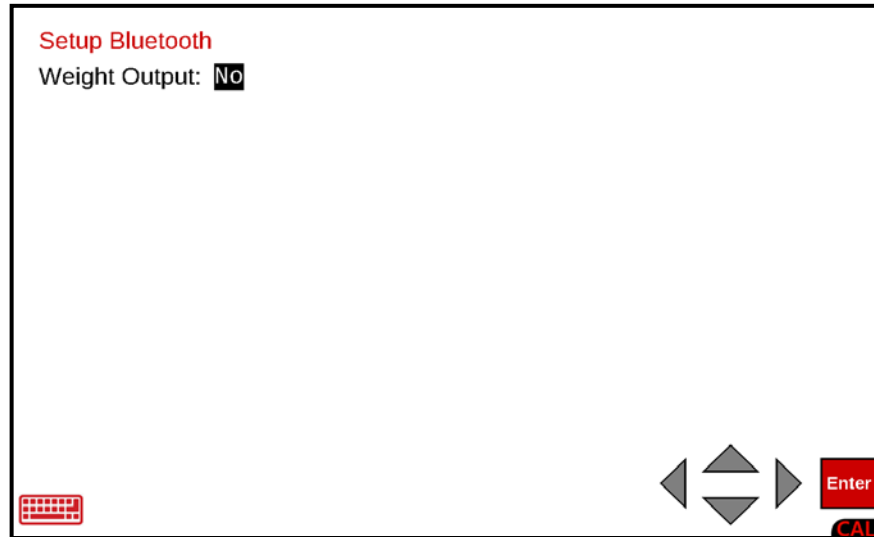
Setup Network Completed

- Press the Navigation Keys ◀ Left Arrow or use the Qwerty keyboard **Esc** key to return to the **Communication Menu** screen.

SETUP, CONT.

Bluetooth

With the **Communication Menu** screen displayed, press the Bluetooth menu option, or use the Qwerty keyboard and press the **B** key to select Bluetooth, or use the Navigation Keys to select (highlight) Bluetooth and press the **ENTER** key. The display will change to show the **Setup Bluetooth** screen.



Weight Output:

With the **Setup Bluetooth** screen displayed the current setting for the Weight Output: parameter will be shown. If the setting displayed is acceptable, press the **ENTER** key to return to the **Communication Menu** screen.

If the current setting is not acceptable, press the **SPACE** key to toggle the setting between Yes and No.

- Select Yes (to make the weight output *available* using a Bluetooth connection) and press the **ENTER** key to return to the **Communication Menu** screen.
- Select No (to make the weight output *unavailable* to a Bluetooth connection) and press the **ENTER** key to return to the **Communication Menu** screen.

SETUP, CONT.

Wifi

With the **Setup Network** screen displayed, press the Wifi menu option, or use the Qwerty keyboard and press the **W** key to select Wifi, or use the Navigation Keys to select (highlight) Wifi and press the **ENTER** key. The display will change to show the **Wifi Enable/Disable** screen.



Wifi Enable:

With the **Wifi Enable/Disable** screen displayed the current setting for the Wifi Enable: parameter will be shown. If the setting displayed is acceptable, press the **ENTER** key to return to the **Setup Network** screen.

If the current setting is not acceptable, press the **SPACE** key to toggle the setting between Yes and No.

- If No is selected, the display will return to the **Setup Network** screen.
- If Yes is selected, the display will change to show (in the middle of the screen)

Shutting down... Cycle Power after shutdown is complete

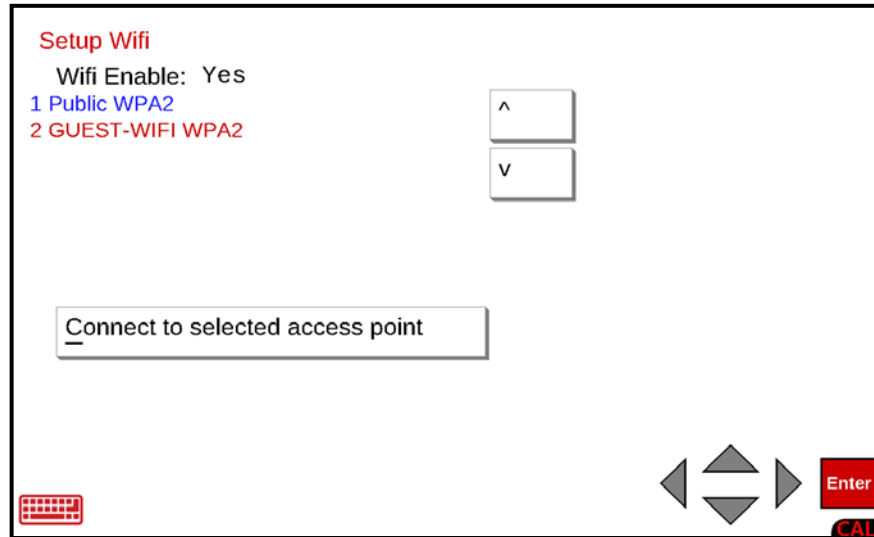
and then blank the display of the indicator. Press the push button power switch to turn the indicator completely off and then press it again to turn the indicator back on

SETUP, CONT.

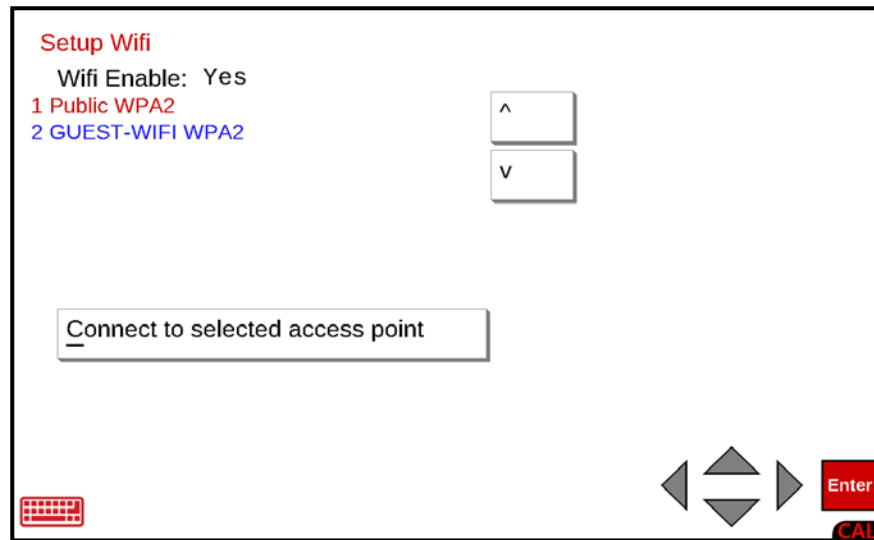
Wifi, Cont.

Setup Wifi

With the **Setup Wifi** screen displayed the current setting for the Wifi Enable: parameter and the available Wifi access points will be shown. Note that the first access point in the list will be highlighted (the text will be blue).



Use the ^ (Up) or v (Down) arrow keys on the touchscreen to select (highlight) the desired access point to connect to. Note that the select access point text will change to blue.



The above **Setup Wifi** screen shows the second access point has been selected (blue text).

SETUP, CONT.

Wifi, Cont.

Setup Wifi, Cont.

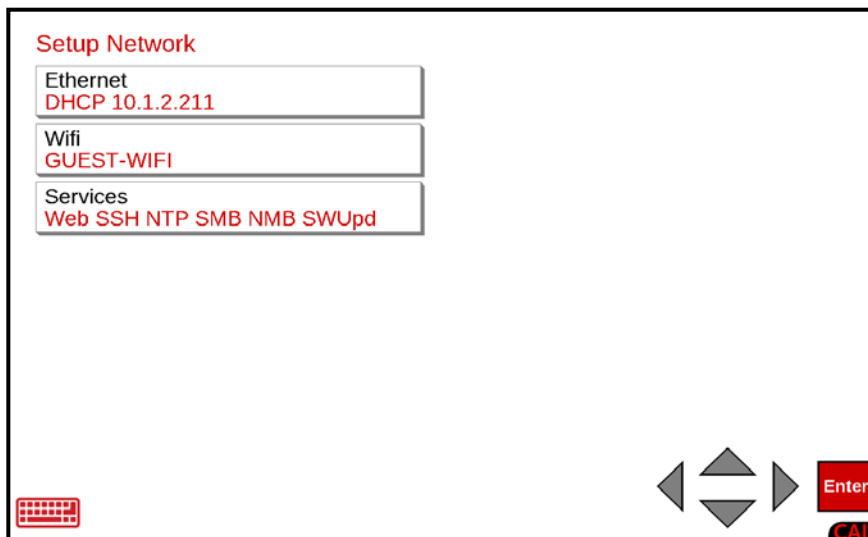
With the desired access point selected, press “Connect to selected access point” on the touchscreen or use the Qwerty keyboard and press the **C** key to connect to the selected access point. The display will change to show the **Wifi Connect Password:** screen.



Use the Qwerty keyboard to enter the password and press the **ENTER** key. The display will change to show Connecting... for several seconds and return to the **Setup Wifi** screen.

With the **Setup Wifi** screen displayed, press the Navigation Keys ◀ Left Arrow or use the Qwerty keyboard **Esc** key to return to the **Setup Network** screen.

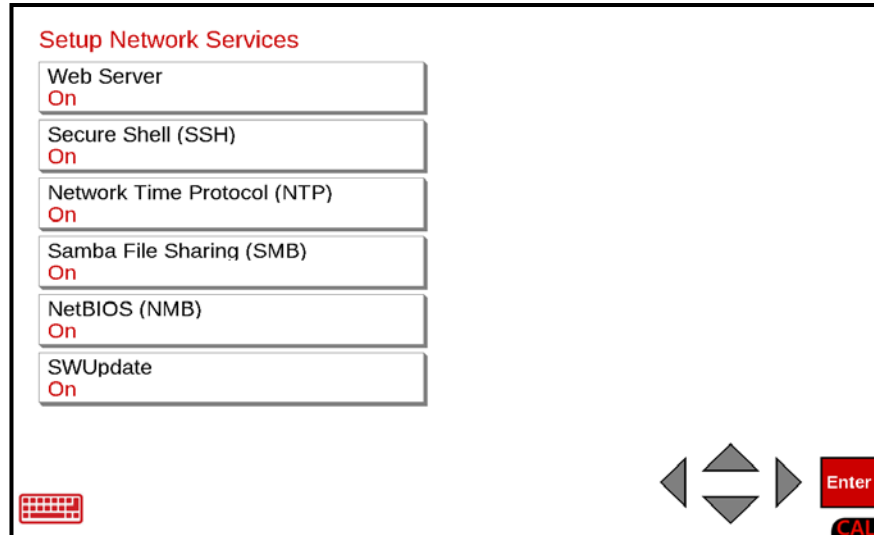
Note that the connected access point will be shown on the Setup Network screen WiFi menu option.



SETUP, CONT.

Services

With the **Setup Network** screen displayed, press the Services menu option, use the Qwerty keyboard, and press the **S** key to select Services, or use the Navigation Keys to select (highlight) Services and press the **ENTER** key. The display will change to show the **Setup Network Services** screen.



Web Server

With the **Setup Network Services** screen displayed the current setting for the Web Server parameter will be shown. If the setting displayed is acceptable, press the ▼ Down Arrow to advance to the next parameter.

If the current setting is not acceptable, press the **SPACE** key to toggle the setting between Yes and No.

- Select Yes to enable the built-in Web Server and press the **ENTER** key to return to the **Setup Network Services** screen.
- Select No to disable the built-in Web Server and press the **ENTER** key to return to the **Setup Network Services** screen.

NOTE: When the Web Server status is changed (to either Yes or No), the display will be blank for a few seconds, return to the **Setup Network Services** screen, and show the updated Web Server status, On or Off.

SETUP, CONT.

Setup Network Services, Cont.

Secure Shell (SSH)

With the **Setup Network Services** screen displayed the current setting for the Secure Shell parameter will be shown. If the setting displayed is acceptable, press the ▼ Down Arrow to advance to the next parameter.

If the current setting is not acceptable, press the **SPACE** key to toggle the setting between Yes and No.

- Select Yes to enable the Secure Shell and press the **ENTER** key to return to the **Setup Network Services** screen.
- Select No to disable the Secure Shell and press the **ENTER** key to return to the **Setup Network Services** screen.

NOTE: When the Secure Shell status is changed (to either Yes or No), the display will blank for a few seconds, return to the **Setup Network Services** screen, and show the updated Secure Shell status, On or Off.

Network Time Protocol

With the **Setup Network Services** screen displayed the current setting for the Network Time Protocol parameter will be shown. If the setting displayed is acceptable, press the ▼ Down Arrow to advance to the next parameter.

If the current setting is not acceptable, press the **SPACE** key to toggle the setting between Yes and No.

- Select Yes to enable automatic date/time updates from a server and press the **ENTER** key to return to the **Setup Network Services** screen.
- Select No to disable automatic date/time updates from a server and press the **ENTER** key to return to the **Setup Network Services** screen.

NOTE: When the Network Time Protocol status is changed (to either Yes or No), the display will blank for a few seconds, return to the **Setup Network Services** screen, and show the updated Network Time Protocol status, On or Off.



IMPORTANT! With the Network Time Protocol *enabled*, setting the date and time on any other setup screen or operation screen will be ignored and the date and time will return to the network date and time.

SETUP, CONT.

Setup Network Services, Cont.

Samba File Sharing (SMB)

With the **Setup Network Services** screen displayed the current setting for the Samba File Sharing (SMB) parameter will be shown. If the setting displayed is acceptable, press the ▼ Down Arrow to advance to the next parameter.

If the current setting is not acceptable, press the **SPACE** key to toggle the setting between Yes and No.

- Select Yes to enable file sharing and press the **ENTER** key to return to the **Setup Network Services** screen.
- Select No to disable file sharing and press the **ENTER** key to return to the **Setup Network Services** screen.

NOTE: When the Samba File Sharing (SMB) status is changed (to either Yes or No), the display will go blank for a few seconds, return to the **Setup Network Services** screen, and show the updated Samba File Sharing (SMB), On or Off.

NetBIOS (NMB)

With the **Setup Network Services** screen displayed the current setting for the NetBIOS (NMB) parameter will be shown. If the setting displayed is acceptable, press the ▼ Down Arrow to advance to the next parameter.

If the current setting is not acceptable, press the **SPACE** key to toggle the setting between Yes and No.

- Select Yes to enable NetBIOS (NMB) and press the **ENTER** key to return to the **Setup Network Services** screen.
- Select No to disable NetBIOS (NMB) and press the **ENTER** key to return to the **Setup Network Services** screen.

NOTE: When the NetBIOS (NMB) status is changed (to either Yes or No), the display will blank for a few seconds, return to the **Setup Network Services** screen, and show the updated NetBIOS (NMB), On or Off.

SETUP, CONT.

Setup Network Services, Cont.

SWUpdate

With the **Setup Network Services** screen displayed the current setting for the SWUpdate parameter will be shown. If the setting displayed is acceptable, press the ▼ Down Arrow to advance to the next parameter.

If the current setting is not acceptable, press the **SPACE** key to toggle the setting between Yes and No.

- Select Yes to enable the SWUpdate Server and press the **ENTER** key to return to the **Setup Network Services** screen.
- Select No to disable the SWUpdate Server and press the **ENTER** key to return to the **Setup Network Services** screen.

NOTE: When the SWUpdate status is changed (to either Yes or No), the display will go blank for a few seconds, return to the **Setup Network Services** screen, and show the updated SWUpdate, On or Off.

Setup Network Services Completed

- Press the Navigation Keys ◀ Left Arrow or use the Qwerty keyboard **Esc** key to return to the **Setup Network** screen.

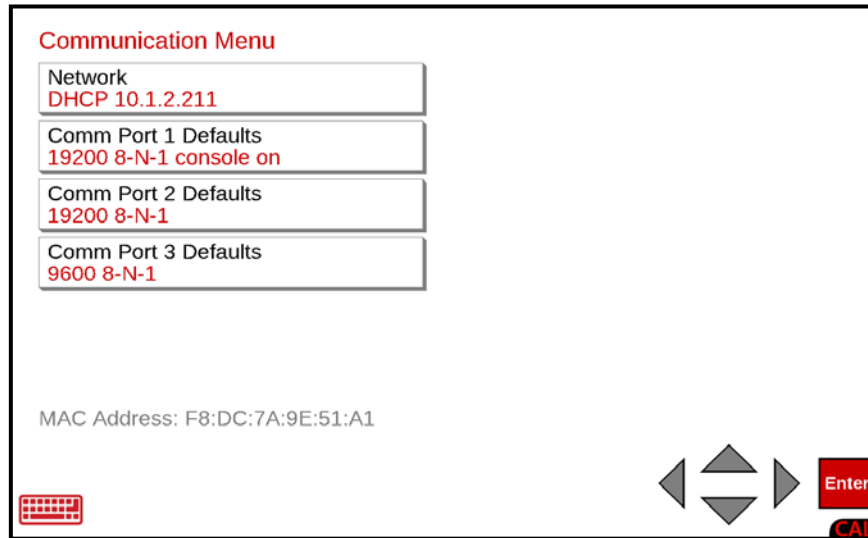
Setup Network Completed

- Press the Navigation Keys ◀ Left Arrow or use the Qwerty keyboard **Esc** key to return to the **Communication Menu** screen.

SETUP, CONT.

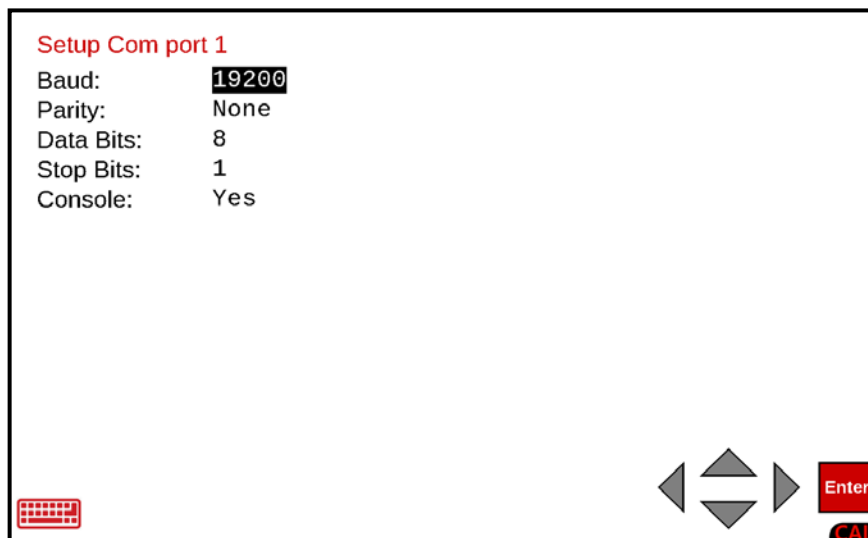
Communication, Cont.

With the **Setup Menu** screen displayed, press the Communication menu option, or use the Qwerty keyboard and press the **C** key to select Communication, or use the Navigation Keys to select (highlight) Communication and press the **ENTER** key. The display will change to show the **Communication Menu** screen.



Comm Port 1 Defaults

With the **Communication Menu** screen displayed, press the Comm Port 1 Defaults menu option, or use the Qwerty keyboard and press the **1** key to select Network, or use the Navigation Keys to select (highlight) Comm Port 1 Defaults and press the **ENTER** key. The display will change to show the **Setup Com port 1** screen.



SETUP, CONT.

Setup Com port 1

Baud:

With the **Setup Com port 1** screen displayed the current setting for the Baud: parameter will be shown. If the setting displayed is acceptable, press the ▼ Down Arrow to advance to the next parameter.

If the current setting is not acceptable, press the **SPACE** key to step through and select the baud rate, and press the ▼ Down Arrow to advance to the next parameter or press the **ENTER** key to save the new setting and return to the **Communication Menu** screen.

Supported Baud rates are:

1200	4800	19200	57600
2400	9600	38400	115200

Parity:

With the **Setup Com port 1** screen displayed the current setting for the Parity: parameter will be shown. If the setting displayed is acceptable, press the ▼ Down Arrow to advance to the next parameter.

If the current setting is not acceptable, press the **SPACE** key to step through and select the parity, and press the ▼ Down Arrow to advance to the next parameter or press the **ENTER** key to save the new setting and return to the **Communication Menu** screen. Supported Parity is:

None (No Parity)	Even	Odd
-------------------------	-------------	------------

Data Bits:

With the **Setup Com port 1** screen displayed the current setting for the Data Bits: parameter will be shown. If the setting displayed is acceptable, press the ▼ Down Arrow to advance to the next parameter.

If the current setting is not acceptable, use the numeric keys to enter the Data Bits and press the ▼ Down Arrow to advance to the next parameter, or press the **ENTER** key to save the new setting and return to the **Communication Menu** screen.

Supported Data Bits are **7** or **8**.

Stop Bits:

With the **Setup Com port 1** screen displayed the current setting for the Stop Bits: parameter will be shown. If the setting displayed is acceptable, press the ▼ Down Arrow to advance to the next parameter.

If the current setting is not acceptable, use the numeric keys to enter the Stop Bits and press the ▼ Down Arrow to advance to the next parameter, or press the **ENTER** key to save the new setting and return to the **Communication Menu** screen.

Supported Stop Bits are **1** or **2**.

SETUP, CONT.

Setup Com port 1, Cont.

Console:

With the **Setup Com port 1** screen displayed the current setting for the Console: parameter will be shown. If the setting displayed is acceptable press the **ENTER** key to return to the **Communication Menu** screen.

If the current setting is not acceptable, press the **SPACE** key to toggle the setting between Yes and No.

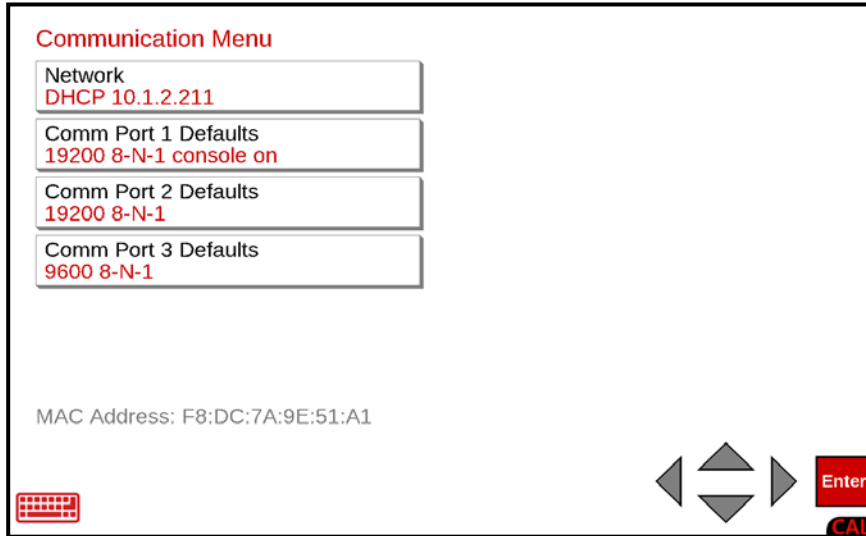
- Select Yes to enable the Console feature and use Com Port 1 to send boot-up diagnostics to an external terminal and press the **ENTER** key to return to the **Communication Menu** screen.
- Select No to disable the Console feature and use Com Port 1 for serial devices such as a printer or badge reader and press the **ENTER** key to return to the **Communication Menu** screen.

NOTE: When the Console status is changed (to either Yes or No), the display will blank momentarily, and then for a few seconds show **Saving Settings** in the upper left corner of the screen, return to the **Communications Menu** screen, and show the updated Console status, On or Off.

SETUP, CONT.

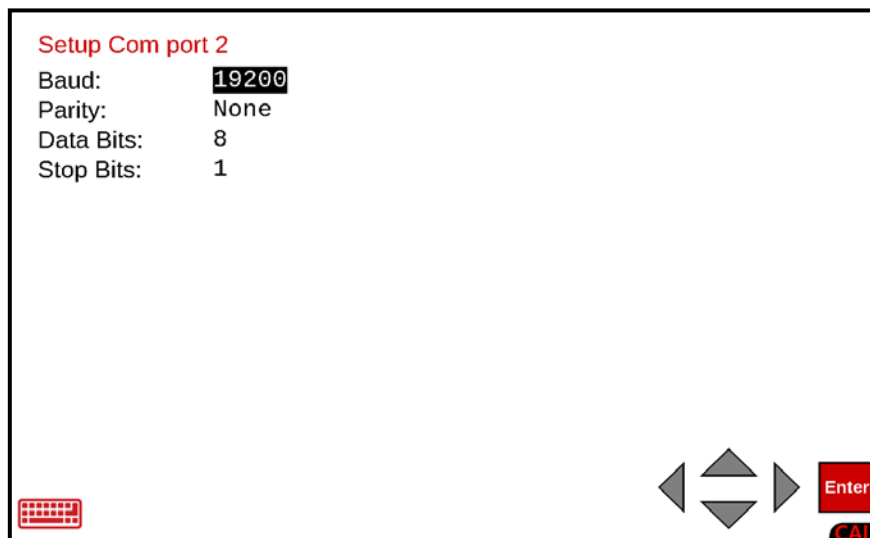
Communication, Cont.

With the **Setup Menu** screen displayed, press the Communication menu option, or use the Qwerty keyboard and press the **C** key to select Communication, or use the Navigation Keys to select (highlight) Communication and press the **ENTER** key. The display will change to show the **Communication Menu** screen.



Comm Port 2 Defaults

With the **Communication Menu** screen displayed, press the Comm Port 2 Defaults menu option, or use the Qwerty keyboard and press the **2** key to select Network, or use the Navigation Keys to select (highlight) Comm Port 2 Defaults and press the **ENTER** key. The display will change to show the **Setup Com port 2** screen.



SETUP, CONT.

Setup Com port 2

Baud:

With the **Setup Com port 2** screen displayed the current setting for the Baud: parameter will be shown. If the setting displayed is acceptable, press the ▼ Down Arrow to advance to the next parameter.

If the current setting is not acceptable, press the **SPACE** key to step through and select the baud rate, and press the ▼ Down Arrow to advance to the next parameter or press the **ENTER** key to save the new setting and return to the **Communication Menu** screen.

Supported Baud rates are:

1200	4800	19200	57600
2400	9600	38400	115200

Parity:

With the **Setup Com port 2** screen displayed the current setting for the Parity: parameter will be shown. If the setting displayed is acceptable, press the ▼ Down Arrow to advance to the next parameter.

If the current setting is not acceptable, press the **SPACE** key to step through and select the parity, and press the ▼ Down Arrow to advance to the next parameter or press the **ENTER** key to save the new setting and return to the **Communication Menu** screen. Supported Parity is:

None (No Parity)	Even	Odd
-------------------------	-------------	------------

Data Bits:

With the **Setup Com port 2** screen displayed the current setting for the Data Bits: parameter will be shown. If the setting displayed is acceptable, press the ▼ Down Arrow to advance to the next parameter.

If the current setting is not acceptable, use the numeric keys to enter the Data Bits and press the ▼ Down Arrow to advance to the next parameter, or press the **ENTER** key to save the new setting and return to the **Communication Menu** screen.

Supported Data Bits are **7** or **8**.

Stop Bits:

With the **Setup Com port 2** screen displayed the current setting for the Stop Bits: parameter will be shown. If the setting displayed is acceptable, press the ▼ Down Arrow to advance to the next parameter.

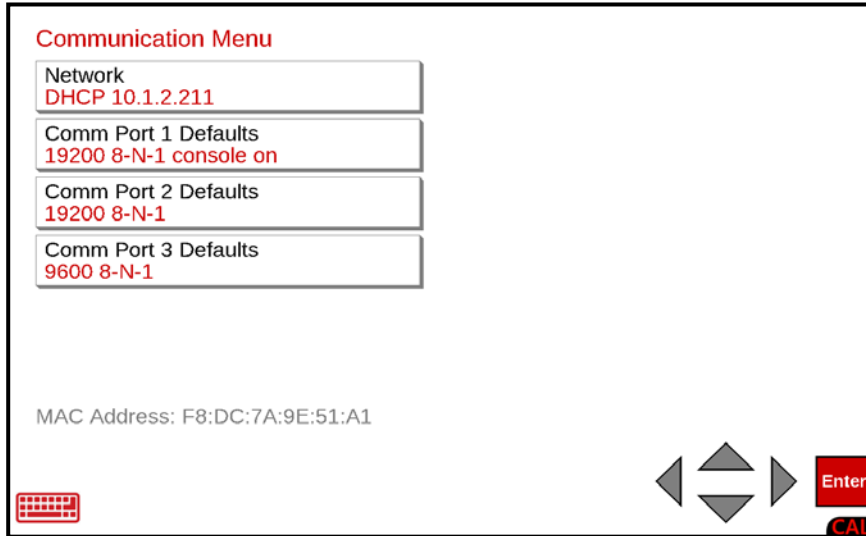
If the current setting is not acceptable, use the numeric keys to enter the Stop Bits and press the ▼ Down Arrow to advance to the next parameter, or press the **ENTER** key to save the new setting and return to the **Communication Menu** screen.

Supported Stop Bits are **1** or **2**.

SETUP, CONT.

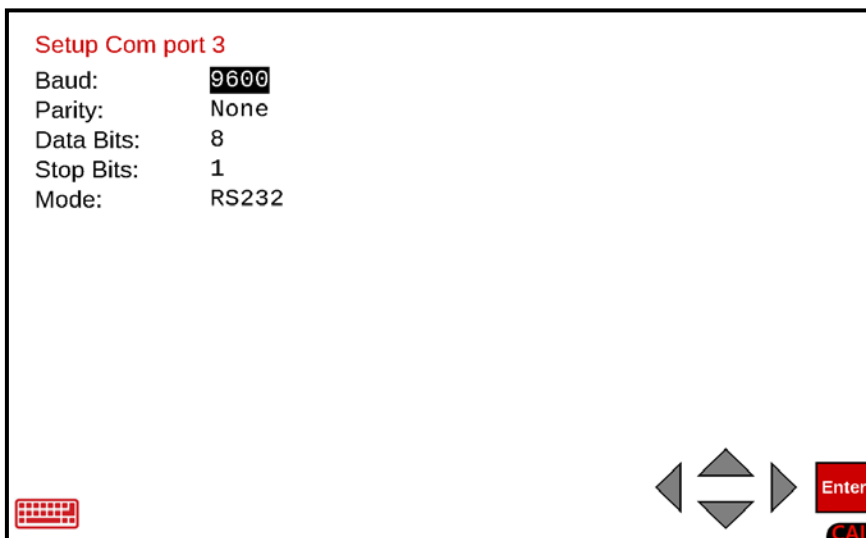
Communication, Cont.

With the **Setup Menu** screen displayed, press the Communication menu option, or use the Qwerty keyboard and press the **C** key to select Communication, or use the Navigation Keys to select (highlight) Communication and press the **ENTER** key. The display will change to show the **Communication Menu** screen.



Comm Port 3 Defaults

With the **Communication Menu** screen displayed, press the Comm Port 2 Defaults menu option, or use the Qwerty keyboard and press the **3** key to select Network, or use the Navigation Keys to select (highlight) Comm Port 3 Defaults and press the **ENTER** key. The display will change to show the **Setup Com port 3** screen.



SETUP, CONT.

Setup Com port 3

Baud:

With the **Setup Com port 3** screen displayed the current setting for the Baud: parameter will be shown. If the setting displayed is acceptable, press the ▼ Down Arrow to advance to the next parameter.

If the current setting is not acceptable, press the **SPACE** key to step through and select the baud rate, and press the ▼ Down Arrow to advance to the next parameter or press the **ENTER** key to save the new setting and return to the **Communication Menu** screen.

Supported Baud rates are:

1200	4800	19200	57600
2400	9600	38400	115200

Parity:

With the **Setup Com port 3** screen displayed the current setting for the Parity: parameter will be shown. If the setting displayed is acceptable, press the ▼ Down Arrow to advance to the next parameter.

If the current setting is not acceptable, press the **SPACE** key to step through and select the parity, and press the ▼ Down Arrow to advance to the next parameter or press the **ENTER** key to save the new setting and return to the **Communication Menu** screen. Supported Parity is:

None (No Parity)	Even	Odd
-------------------------	-------------	------------

Data Bits:

With the **Setup Com port 3** screen displayed the current setting for the Data Bits: parameter will be shown. If the setting displayed is acceptable, press the ▼ Down Arrow to advance to the next parameter.

If the current setting is not acceptable, use the numeric keys to enter the Data Bits and press the ▼ Down Arrow to advance to the next parameter, or press the **ENTER** key to save the new setting and return to the **Communication Menu** screen.

Supported Data Bits are **7** or **8**.

Stop Bits:

With the **Setup Com port 3** screen displayed the current setting for the Stop Bits: parameter will be shown. If the setting displayed is acceptable, press the ▼ Down Arrow to advance to the next parameter.

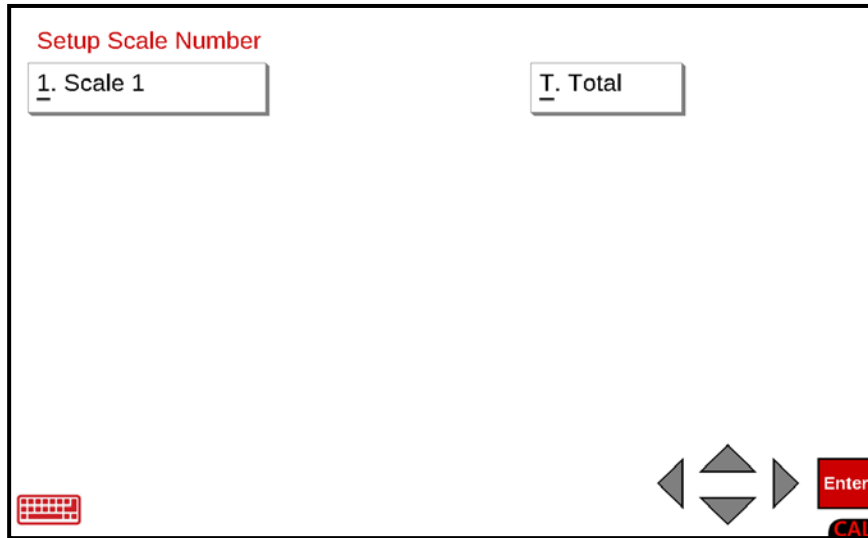
If the current setting is not acceptable, use the numeric keys to enter the Stop Bits and press the ▼ Down Arrow to advance to the next parameter, or press the **ENTER** key to save the new setting and return to the **Communication Menu** screen.

Supported Stop Bits are **1** or **2**.

SETUP, CONT.

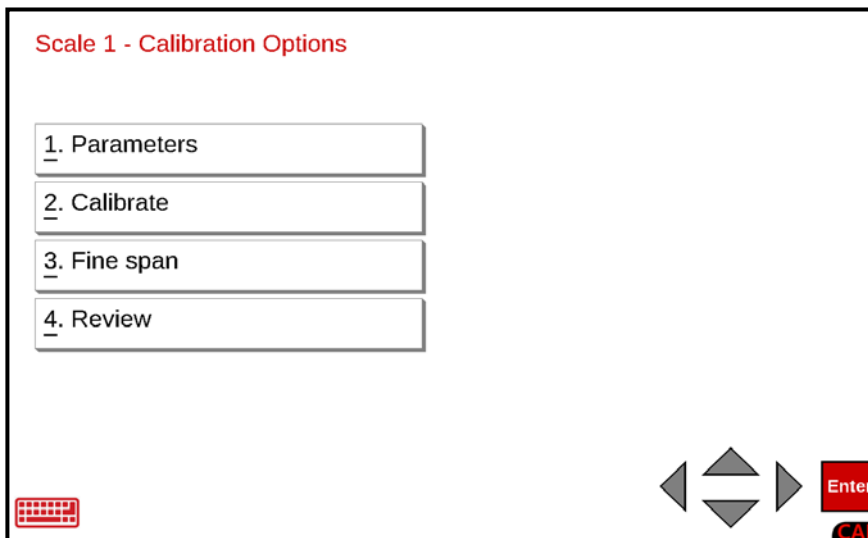
Calibration

With the **Setup Menu** screen displayed, press the Calibration menu option, or use the Qwerty keyboard and press the **b** key to select Calibration, or use the Navigation Keys to select (highlight) Calibration and press the **ENTER** key. The display will change to show the **Setup Scale Number** screen.



Setup Scale Number

With the **Setup Scale Number** screen displayed, press the 1. Scale 1 menu option or use the Qwerty keyboard and press the **1** key to select Scale 1 or use the Navigation Keys to select (highlight) Scale 1 and press the **ENTER** key. The display will change to show the **Scale 1 - Calibration Options** screen.

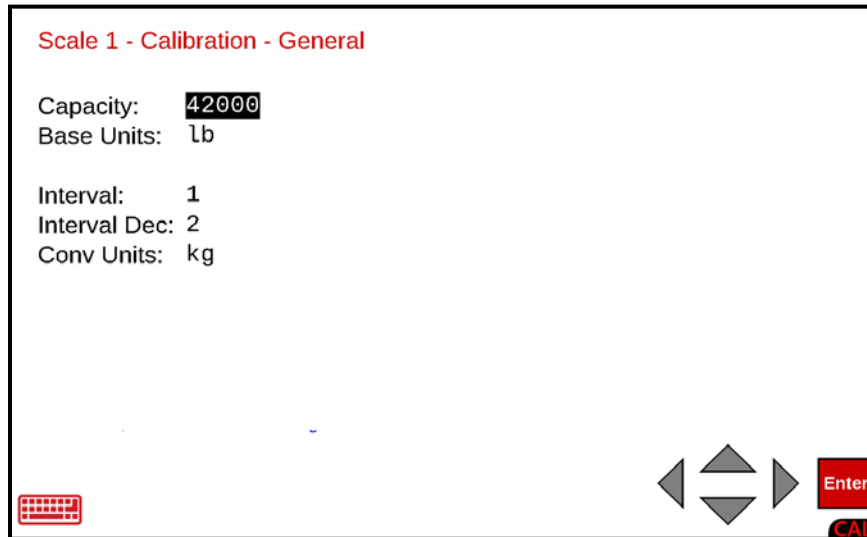


1. Parameters

With the **Scale 1 - Calibration Options** screen displayed, press the 1. Parameters menu option or use the Qwerty keyboard and press the **1** key to select 1. Parameters, or use the Navigation Keys to select (highlight) 1. Parameters and press the **ENTER** key. The display will change to show the **Scale 1 - Calibration - General** screen.

SETUP, CONT.

Scale 1 - Calibration - General



Capacity:

With the **Scale 1 - Calibration - General** screen displayed the current setting for the Capacity: parameter will be shown. If the setting displayed is acceptable, press the ▼ Down Arrow to advance to the next parameter.

If the current setting is not acceptable, use the numeric keys to enter the maximum weight that may be weighed on the scale and press the ▼ Down Arrow to advance to the next parameter or press the **ENTER** key to save the new setting and proceed to the **Scale 1 - Calibration - Filtering** screen. Note that the Capacity cannot exceed 7 digits.

Allowable values are 1 through 9,999,999.

Base Units:

With the **Scale 1 - Calibration - General** screen displayed the current setting for the Base Units: parameter will be shown. If the setting displayed is acceptable, press the ▼ Down Arrow to advance to the next parameter.

If the current setting is not acceptable, press the **SPACE** key to step through and select the Base Units, and press the ▼ Down Arrow to advance to the next parameter or press the **ENTER** key to save the setting and proceed to the **Scale 1 - Calibration - Filtering** screen.

Supported Base Units are:

lb (pounds)

tn (tons)

Custom (see NOTE: below)

kg (kilograms)

tonne (metric tons)

NOTE: If Custom is selected for Base Units:, an additional parameter (Custom label:) will be shown (below the Base Units: parameter) and requires data to be entered. Proceed to the Custom label: parameter following the Conv Units: parameter.

SETUP, CONT.

Interval:

With the **Scale 1 - Calibration - General** screen displayed the current setting for the Interval: parameter will be shown. If the setting displayed is acceptable, press the ▼ Down Arrow to advance to the next parameter.

NOTE! If using multiple intervals, this is the low interval.

If the current setting is not acceptable, use the numeric keys to enter the interval (or minimum increment of weight reading) and press the ▼ Down Arrow to advance to the next parameter or press the **ENTER** key to save the new setting and proceed to the **Scale 1 - Calibration - Filtering** screen.

Allowable values are **1, 2, 5, 10, 20, 50, or 100.**

Interval Dec:

With the **Scale 1 - Calibration - Conversion** screen displayed the current setting for the Interval Dec: parameter will be shown. If the setting displayed is acceptable, press the ▼ Down Arrow to advance to the next parameter.

If the current setting is not acceptable, use the numeric keys to enter the interval decimal places and press the ▼ Down Arrow to advance to the next parameter, or press the **ENTER** key to save the new setting and proceed to the **Scale 1 - Calibration - Filtering** screen.

Allowable values are **0 to 5.**

0 = #####	2 = #####.##	4 = ###.####
1 = #####.#	3 = #####.###	5 = ##.#####

Conv Units:

With the **Scale 1 - Calibration - General** screen displayed the current setting for the Conv Units: parameter will be shown. If the setting displayed is acceptable, press the **ENTER** key to proceed to the **Scale 1 - Calibration - Filtering** screen, or use the Navigation Keys ◀ Left Arrow to return to the **Scale 1 - Calibration - Options** screen.

If the current setting is not acceptable, press the **SPACE** key to step through and select the Conv Units and press the **ENTER** key to save the new setting, and proceed to the **Scale 1 - Calibration - Filtering** screen.

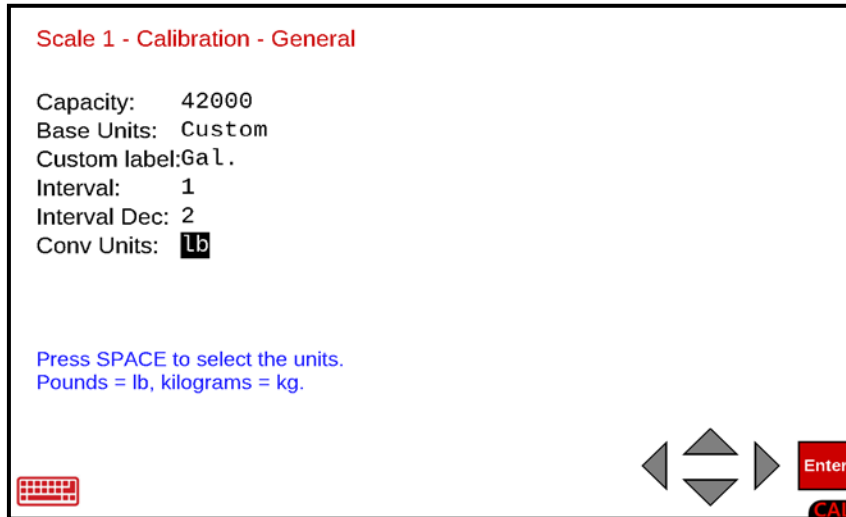
Supported Conv Units are:

lb (pounds)	tn (tons)	Custom (see NOTE: below)
kg (kilograms)	tonne (metric tons)	

NOTE: If Custom is selected for Conv Units:, an additional parameter (Custom label:) will be shown (below the Conv Units: parameter) and requires data to be entered. Proceed to the Custom label: parameter.

SETUP, CONT.

Custom Label: (Base Units:)



With Custom selected for the Base Units: the current setting for the Custom label: parameter will be shown. If the setting displayed for Base Units: Custom label is acceptable, press the ▼ Down Arrow to advance to the next parameter or press the **ENTER** key to proceed to the **Scale 1 - Calibration - Conversion** screen.

If the current setting is not acceptable, use the Qwerty keyboard to enter a new description (up to 5 characters) for the Base Units: Custom label, and press the **ENTER** key to save the new setting and proceed to the **Scale 1 - Calibration - Conversion** screen.

Custom Label: (Conv Units:)

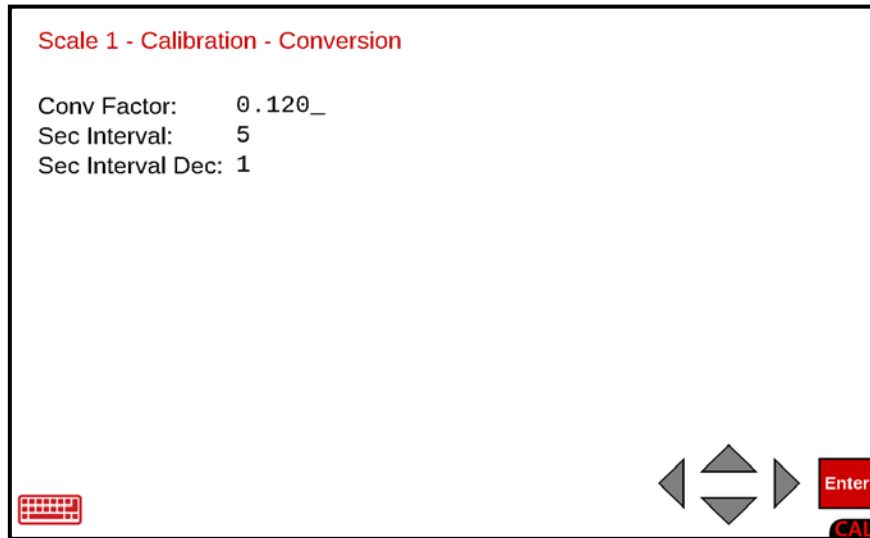


With Custom selected for the Conv Units: the current setting for the Custom label: parameter will be shown. If the setting displayed for Conv Units: Custom label is acceptable, press the **ENTER** key to proceed to the **Scale 1 - Calibration - Conversion** screen.

If the current setting is not acceptable, use the Qwerty keyboard to enter a new description (up to 5 characters) for the Conv Units: Custom label, and press the **ENTER** key to save the new setting and proceed to the **Scale 1 - Calibration - Conversion** screen.

SETUP, CONT.

Scale 1 - Calibration - Conversion



Conversion Factor (Conv Factor:)

The Conversion Factor (Conv Factor) is a number that the Base Units (or Conv Units) must be multiplied by to obtain the Custom unit of measurement.

For example, to find the weight of water in a container:

Note that in the example screen shown on the previous page, Gal. (for Gallons) has been entered for the Base Units: Custom label.

1. To weigh water, we begin with the fact that at room temperature (70°F or 21°C), water weighs 8.33 pounds per 1 Gallon.
2. To compute the conversion factor, you would divide 1 gallon by 8.33 pounds, with the result being 0.120.
3. Therefore, if the NET weight displayed was 276.5 lb, pressing the **UNITS** key would change the display to show 33.2 Gal. ($276.5 \times 0.120 = 33.18$, rounded up to 33.2).

Conv Factor:

With the **Scale 1 - Calibration - Conversion** screen displayed the current setting for the Conv Factor: parameter will be shown. If the setting displayed is acceptable, press the ▼ Down Arrow to advance to the next parameter or press the **ENTER** key to save the setting and proceed to the **Scale 1 - Calibration - Filtering** screen.

If the current setting is not acceptable, use the numeric keys to enter the conversion factor and press the ▼ Down Arrow to advance to the next parameter, or press the **ENTER** key to save the new setting and proceed to the **Scale 1 - Calibration - Filtering** screen.

NOTE: The conversion factor cannot exceed 7 digits (including the decimal point).

SETUP, CONT.

Sec Interval:

With the **Scale 1 - Calibration - Conversion** screen displayed the current setting for the Sec Interval: parameter will be shown. If the setting displayed is acceptable, press the ▼ Down Arrow to advance to the next parameter or press the **ENTER** key to save the setting and proceed to the **Scale 1 - Calibration - Filtering** screen.

NOTE: If using multiple intervals, this is the low interval.

If the current setting is not acceptable, use the numeric keys to enter the interval (or minimum increment of weight reading) and press the ▼ Down Arrow to advance to the next parameter or press the **ENTER** key to save the new setting and proceed to the **Scale 1 - Calibration - Filtering** screen.

Allowable values are **1, 2, 5, 10, 20, 50, or 100.**

Sec Interval Dec:

With the **Scale 1 - Calibration - Conversion** screen displayed the current setting for the Sec Interval Dec: parameter will be shown. If the setting displayed is acceptable, press the **ENTER** key to save the setting and proceed to the **Scale 1 - Calibration - Filtering** screen, or use the Navigation Keys ◀ Left Arrow to return to the **Scale 1 - Calibration - General** screen.

If the current setting is not acceptable, use the numeric keys to enter the interval decimal places and press the **ENTER** key to save the new setting, and proceed to the **Scale 1 - Calibration - Filtering** screen.

Allowable values are **0 to 5.**

0 = #####

2 = #####.##

4 = ###.####

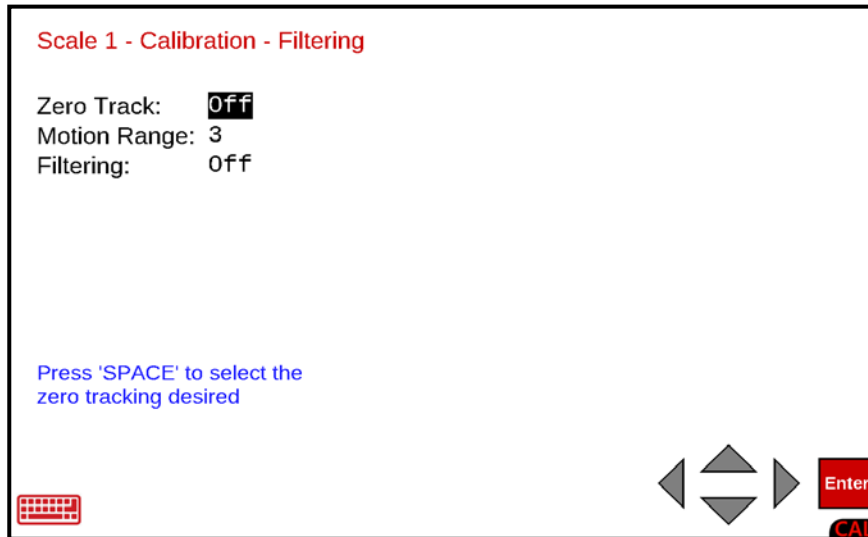
1 = #####.#

3 = ####.###

5 = ##.#####

SETUP, CONT.

Scale 1 - Calibration - Filtering



Zero Track:

With the **Scale 1 - Calibration - Filtering** screen displayed the current setting for the Zero Track: (zero tracking) parameter will be shown. If the setting displayed is acceptable, press the ▼ Down Arrow to advance to the next parameter.

If the current setting is not acceptable, press the **SPACE** key to step through and select the zero tracking range, and press the ▼ Down Arrow to advance to the next parameter or press the **ENTER** key to save the new setting and proceed to the **Scale 1 - Calibration - Options** screen.

Available selections are Off, 0.5 div, and 1 through 9 div.

Off 0.5 div 1 div 2 div 3 div 4 div 5 div 6 div 7 div 8 div 9 div

Motion Range:

With the **Scale 1 - Calibration - Filtering** screen displayed the current setting for the Motion Range: parameter will be shown. If the setting displayed is acceptable, press the ▼ Down Arrow to advance to the next parameter.

If the current setting is not acceptable, use the numeric keys to enter the motion range (the number of divisions of change permitted before indicating unstable) and press the ▼ Down Arrow to advance to the next parameter or press the **ENTER** key to save the new setting and proceed to the **Scale 1 - Calibration - Options** screen.

Allowable values are **0** to **9**.

NOTE: Entering zero (**0**) will disable the motion range.

SETUP, CONT.

Filtering:

With the **Scale 1 - Calibration - Filtering** screen displayed the current setting for the Filtering: parameter will be shown. If the setting displayed is acceptable, press the **ENTER** key to save the setting and proceed to the **Scale 1 - Calibration - Options** screen, or use the Navigation Keys ◀ Left Arrow to return to the previous screen.

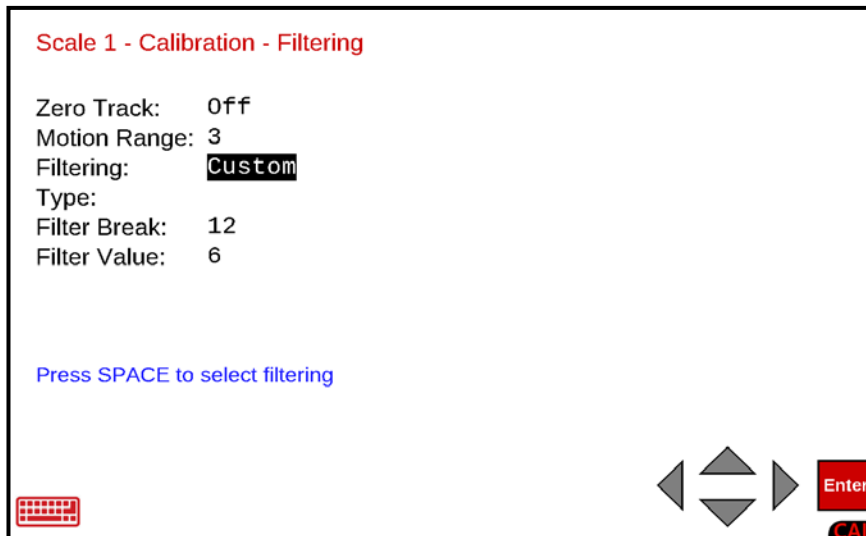
If the current setting is not acceptable, press the **SPACE** key to step through and select the digital filtering, and press the **ENTER** key to save the new setting and proceed to the **Scale 1 - Calibration - Options** screen.

Allowable selections are **Off**, **Minimal**, **Moderate**, and **Custom**.

Off	Disabled (No Filtering)
Minimal	Minimal Filtering (Sample Rate automatically set to 2)
Moderate	Moderate Filtering (Sample Rate automatically set to 1)
Custom	Custom Filtering (Additional Parameters displayed, data entry required)

NOTE: If Custom is selected for Filtering: additional parameters, Type:, Filter Break:, and Filter Value: will be shown (below the Filtering: parameter) and requires data to be entered. Proceed to the Custom Filtering: parameter.

Custom Filtering:



Type:

With Custom selected for Filtering:, the current setting for the Type: parameter will be shown. If the setting displayed is acceptable, press the ▼ Down Arrow to advance to the next parameter or press the **ENTER** key to save the new setting and proceed to the **Scale 1 - Calibration - Options** screen.

SETUP, CONT.

Custom Filtering:, Cont.

Type:, Cont.

If the current setting for Type: is not acceptable, press the **SPACE** key to toggle between the selections and press the ▼ Down Arrow to advance to the next parameter or press the **ENTER** key to save the new setting and proceed to the **Scale 1 - Calibration - Options** screen.

Allowable selections are **IIR** or **FIR**.

IIR (Infinite Impulse Response) - Same as previous custom filtering.

FIR (Finite Impulse Response) - Better for high sample rates, and high-speed weighing.

Filter Break:

The filter break range is a number from 1 to 64 that corresponds to the number of division changes to break out of the filtering.

With Custom selected for Filtering:, the current setting for the Filter Break: parameter will be shown. If the setting displayed is acceptable, press the ▼ Down Arrow to advance to the next parameter or press the **ENTER** key to save the new setting and proceed to the **Scale 1 - Calibration - Options** screen.

If the current setting is not acceptable, use the numeric keys to enter the value for the filter break range and press the ▼ Down Arrow to advance to the next parameter or press the **ENTER** key to save the new setting and proceed to the **Scale 1 - Calibration - Filtering** screen.

Allowable values are **1** to **64**.

Filter Value:

The filter value is a number from 1 to 255 that corresponds to the level of filtering with 255 being the greatest filtering and 1 the least.

With Custom selected for Filtering:, the current setting for the Filter Value: parameter will be shown. If the setting displayed is acceptable, press the **ENTER** key to save the setting and proceed to the **Scale 1 - Calibration - Options** screen, or use the Navigation Keys ◀ Left Arrow to return to the previous screen.

If the current setting is not acceptable, use the numeric keys to enter the value for the filter value and press the **ENTER** key to save the new setting, and proceed to the next screen.

Allowable values are **1** to **255**.

SETUP, CONT.

Filter Setting Recommendations

Non-Critical Sample Rate

If the sample rate is not critical, as in static weighing, set **Filtering:** to:

- **Filtering: Off**
(No Filtering)
- **Filtering: Minimal**
(Filter Value: 6, Filter Break: 12, Sample Rate: 2/Sec)
- **Filtering: Moderate**
(Filter Value: 6, Filter Break: 8, Sample Rate: 1/Sec)

Critical Sample Rate

With a critical sample rate, as in a filling operation, use (**Filtering: Custom**).

1. **Sample Rate:** (1 to 200 samples/second) determination:

Set the sample rate as close as possible to produce a display graduation change for every graduation of material added to the scale.

$$\frac{\text{Material Flow Rate (lbs/second)}}{\text{Interval}} = \text{Sample Rate:}$$

$$\text{EXAMPLE: } \frac{100\text{lbs/sec}}{10\text{lbs}} = 10\text{s/s} = \text{Sample Rate:}$$

3. **Filter Value:** (1 to 255) determination:

Set to desired results.

3. **Filter Break:** (1 to 64 graduations) determination:

Turn the filtering off by setting **Filtering: Off**. Operate the system as it will be normally used and, by observation, determine the number of graduations of instability that need to be filtered out. Set the **Filter Break:** range to that value.

$$\frac{\text{Weight Change}}{\text{Interval}} = \text{Filter Break:}$$

EXAMPLE: 20,000 x 10lb capacity scale with 800lb variation in the weight display.

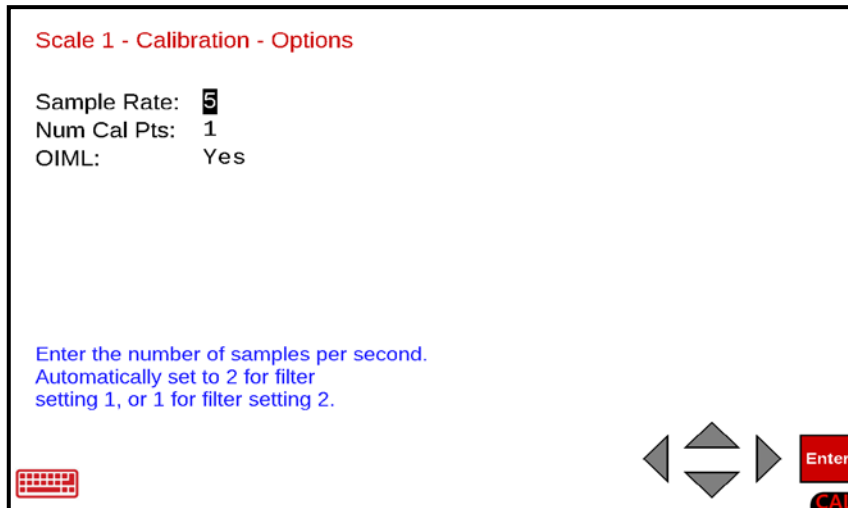
$$\frac{800}{10} = \text{Filter Break: } 80$$

4. **Unacceptable Stability**

If stability is unacceptable with any setting of **Filter Value:**, reduce the **Sample Rate:** and/or increase the **Filter Break:** range setting for increased filtering.

SETUP, CONT.

Scale 1 - Calibration - Options



Sample Rate:

With the **Scale 1 - Calibration - Options** screen displayed the current setting for the Sample Rate: parameter will be shown. If the setting displayed is acceptable, press the ▼ Down Arrow to advance to the next parameter.

If the current setting is not acceptable, use the numeric keys to enter the sample rate in samples per second and press the ▼ Down Arrow to advance to the next parameter or press the **ENTER** key to save the new setting and proceed to the **Scale 1 - Calibration - Other Options** screen.

Allowable values are **1** to **200**.

NOTE: The Sample Rate: will automatically be set to 2 when Minimal Filtering: has been selected, or to 1 when Moderate Filtering has been selected.

Num Cal Pts:

Calibration of the scale can be performed using multiple calibration points to obtain a more precise weight reading over the entire span of the scale. The Num Cal Pts: parameter is used to select the number of calibration points in addition to the zero (no load) weight calibration point. **DO NOT** include the zero (no load) weight calibration point when selecting the number of calibration points. For example, by selecting 2 for Num Cal Pts:, you would have a total of three calibration points, zero (no load) weight, and two calibration points that could correspond to a mid-point weight and the test (load) weight.

With the **Scale 1 - Calibration - Options** screen displayed the current setting for the Num Cal Pts: parameter will be shown. If the setting displayed is acceptable, press the ▼ Down Arrow to advance to the next parameter.

If the current setting is not acceptable, use the numeric keys to enter a new number of calibration points and press the ▼ Down Arrow to advance to the next parameter or press the **ENTER** key to save the new setting and proceed to the **Scale 1 - Calibration - Other Options** screen.

Allowable values are **1** to **4**.

SETUP, CONT.

OIML:

This parameter determines whether the indicator will be used in an application requiring OIML (International Organization of Legal Metrology) compliance.

With the **Scale 1 - Calibration - Options** screen displayed the current setting for the OIML: parameter will be shown. If the setting displayed is acceptable, press the **ENTER** key to save the setting and proceed to the **Scale 1 - Calibration - Other Options** screen or use the Navigation Keys ◀ Left Arrow to return to the **Scale 1 - Calibration - Filtering** screen.

If the current setting is not acceptable, press the **SPACE** key to toggle the setting between Yes and No.

- Select **Yes** to enable OIML compliance and press the **ENTER** key to save the setting and proceed to the **Scale 1 - Calibration - Other Options** screen.

With Yes selected:

- a. Manual Tare Entry (PT is displayed and printed)
 - b. Single Interval weight displays:
 - Max (Maximum Capacity)
 - Min (Minimum Capacity)
 - e (Scale Interval)
- Select **No** to disable OIML compliance and press the **ENTER** key to save the setting and proceed to the **Scale 1 - Calibration - Other Options** screen.

With No: selected:

- a. Manual Tare Entry (MAN WT is displayed and printed)
- b. Single Interval weight displays:
 - Scale Capacity and Interval

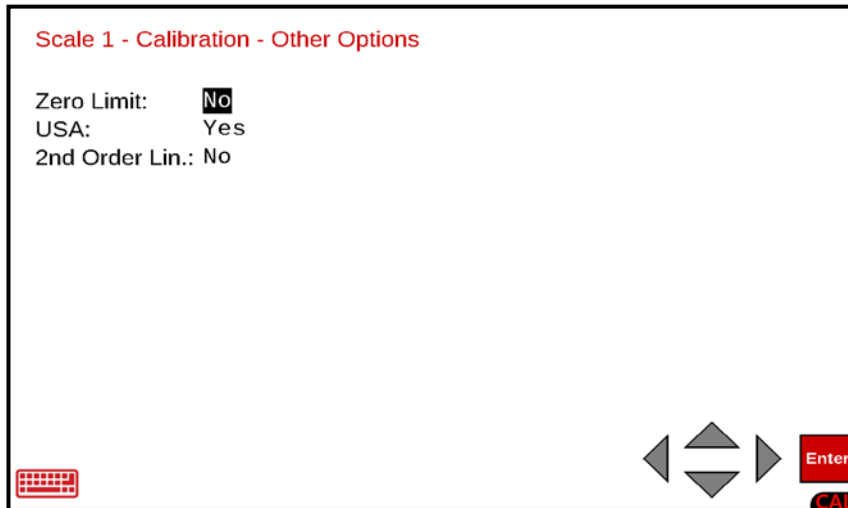


IMPORTANT! Selecting Yes meets International Organization of Legal Metrology (OIML) compliance.

- When **Yes** is selected, serial Comm Port 3 will be dedicated to outputting the scale gross weight whenever the application program is executing. The application program cannot manipulate this output in any way.
- The serial Comm Port 3 communications parameters will default to 9600 baud, 8 data bits, no parity bits, and 1 stop bit.
- The data will be sent out at a rate of 2 times per second.
- Note that the serial Comm Port 3 communication parameters can be changed in the **Communication Menu, Setup Com port 3** screen.

SETUP, CONT.

Scale 1 - Calibration - Other Options



Zero Limit:

With the **Scale 1 - Calibration - Other Options** screen displayed the current setting for the Zero Limit: parameter will be shown. If the setting displayed is acceptable, press the ▼ Down Arrow to advance to the next parameter.

If the current setting is not acceptable, press the **SPACE** key to toggle the setting between Yes and No.

- Select **Yes** to enable the Zero Limit and press the ▼ Down Arrow to advance to the next parameter. Note that selecting **Yes** will limit the push button zero and zero tracking to $\pm 2\%$ of the scale capacity.
- Select **No** to disable the Zero Limit and press the ▼ Down Arrow to advance to the next parameter. Note that selecting **No** will allow the push button zero and zero tracking to zero up to the full capacity of the scale.

USA:

This parameter selects whether the indicator is used in the USA (domestic) or outside the USA (international). If the setting displayed is acceptable, proceed to the next parameter.

With the **Scale 1 - Calibration - Other Options** screen displayed the current setting for the USA: parameter will be shown. If the setting displayed is acceptable, press the ▼ Down Arrow to advance to the next parameter.

If the current setting is not acceptable, press the **SPACE** key to toggle the setting between Yes and No.

- Select **Yes** to enable USA: and press the ▼ Down Arrow to advance to the next parameter. Note that selecting **Yes** allows Over Capacity up to 104% of scale capacity.
- Select **No** to disable USA: and press the ▼ Down Arrow to advance to the next parameter. Note that selecting **No** will allow the push button zero and zero tracking to zero up to the full capacity of the scale.

SETUP, CONT.

2nd Order Lin:

2nd Order Linearization is a method used to correct for nonlinearity in the load cell signal. An extra term, which is proportional to the square of the load cell signal, is used in the conversion of the load cell signal into a weight value.

With the **Scale 1 - Calibration - Other Options** screen displayed the current setting for the 2nd Order Lin: parameter will be shown. If the setting displayed is acceptable, press the **ENTER** key to proceed to the **Scale 1 - Calibration - Multi Interval** screen, or use the Navigation Keys ◀ Left Arrow to return to the **Scale 1 - Calibration - Other Options** screen.

If the current setting is not acceptable, press the **SPACE** key to toggle the setting between Yes and No.

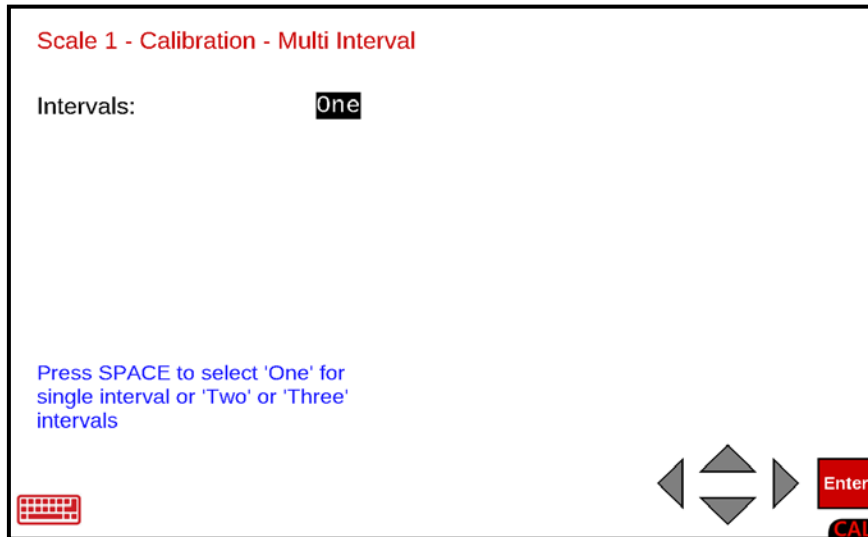
- Select **Yes** to enable 2nd Order Lin: and press the **ENTER** key to proceed to the **Scale 1 - Calibration - Multi Interval** screen. Note that when selecting **Yes**, the Fine Span screen will have the additional option **Coeff** added to it.
- Select **No** to disable 2nd Order Lin: and press the **ENTER** key to proceed to the **Scale 1 - Calibration - Multi Interval** screen. Note that when selecting **No**, the Fine Span screen will only have the Up, Down, Zero, and Quit options.



IMPORTANT! For 2nd Order Linearization to take effect, calibration must be performed with at least a total of three calibration points (no load and two load points with different weights). If only two calibration points (no load and load) are used, the **Coeff** option will **NOT** be added to the Fine Span screen.

SETUP, CONT.

Scale 1 - Calibration - Multi Interval



Intervals:

With the **Scale 1 - Calibration - Multi Interval** screen displayed the current setting for the Intervals: parameter will be shown. If the setting displayed is acceptable, press the **ENTER** key to save the setting.

The display will change to show Setting Parameters and then Setting Multi-Interval in the upper left corner and return to the **Scale 1 - Calibration Options** screen.

If the current setting is not acceptable, press the **SPACE** key to step through and select the Interval (number of weight ranges to use).

Allowable selections are **One**, **Two**, or **Three**.

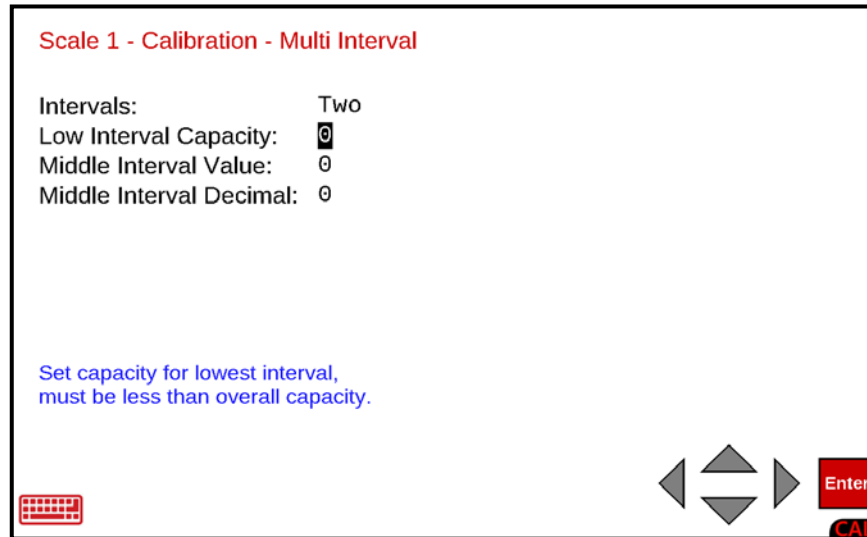
With One selected for Intervals

Select **One** for Single Interval and press the **ENTER** key to save the new setting.

The display will change to show Setting Parameters and then Setting Multi-Interval in the upper left corner and then return to the **Scale 1 - Calibration Options** screen.

SETUP, CONT.

Intervals:, Cont.



With Two selected for Intervals

If **Two** is selected, three (3) additional parameters will be displayed on the screen. Press the ▼ Down Arrow to advance to the Low Interval Capacity: parameter.

Low Interval Capacity:

This is the weight capacity for the low interval. If the setting displayed is acceptable, press the ▼ Down Arrow to advance to the Middle Interval Value: parameter.

If the current setting is not acceptable, use the numeric keys to enter the capacity for the low interval and press the ▼ Down Arrow to advance to the Middle Interval Value: parameter.

Note that the value entered for Low Interval Capacity cannot exceed 7 digits and must be less than the overall capacity.

Middle Interval Value:

This is the middle interval value. If the setting displayed is acceptable, press the ▼ Down Arrow to advance to the Middle Interval Decimal: parameter.

If the current setting is not acceptable, use the numeric keys to enter the middle interval weight increment value and press the ▼ Down Arrow to advance to the Middle Interval Decimal: parameter.

Note that the value entered for the Middle Interval Value: cannot exceed 7 digits and must be greater than the low interval value.

SETUP, CONT.

Intervals:, Cont.

Middle Interval Decimal:

This is the number of decimal places for the middle interval value. If the setting displayed is acceptable, press the **ENTER** key to save the setting.

The display will change to show Setting Parameters and then Setting Multi-Interval in the upper left corner and return to the **Scale 1 - Calibration Options** screen.

If the current setting is not acceptable, use the numeric keys to enter the middle interval decimal places and press the **ENTER** key to save the new setting.

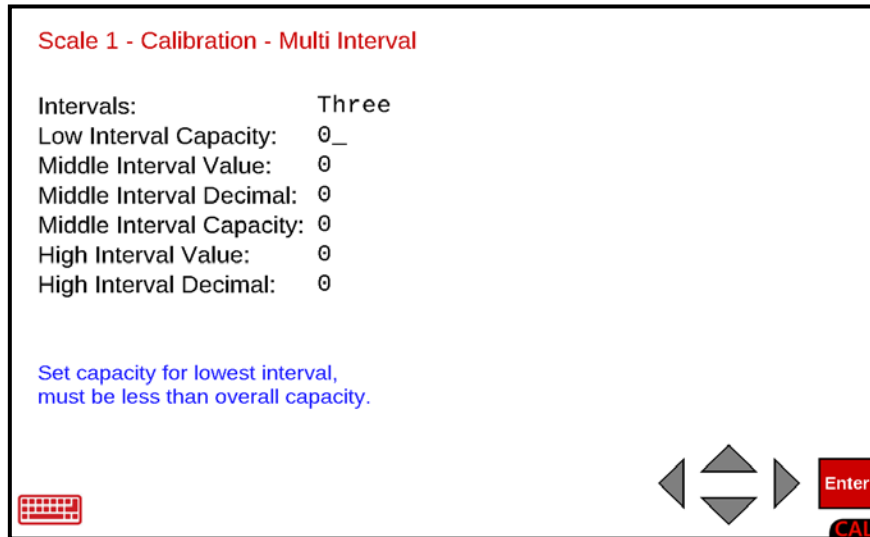
Allowable values are **0** to **4**.

0 = ##### **1 = #####.#** **2 = #####.##** **3 = #####.###** **4 = ###.####**

The display will change to show Setting Parameters and then Setting Multi-Interval in the upper left corner and return to the **Scale 1 - Calibration Options** screen.

SETUP, CONT.

Intervals:, Cont.



With Three selected for Intervals

If **Three** is selected, six (6) additional parameters will be displayed on the screen. Press the ▼ Down Arrow to advance to the Low Interval Capacity: parameter.

Low Interval Capacity:

This is the weight capacity for the low interval. If the setting displayed is acceptable, press the ▼ Down Arrow to advance to the Middle Interval Value: parameter.

If the current setting is not acceptable, use the numeric keys to enter the capacity for the low interval and press the ▼ Down Arrow to advance to the Middle Interval Value: parameter.

Note that the value entered for Low Interval Capacity cannot exceed 7 digits and must be less than the overall capacity.

Middle Interval Value:

This is the middle interval value. If the setting displayed is acceptable, press the ▼ Down Arrow to advance to the Middle Interval Decimal: parameter.

If the current setting is not acceptable, use the numeric keys to enter the middle interval weight increment value and press the ▼ Down Arrow to advance to the Middle Interval Decimal: parameter.

Note that the value entered for the Middle Interval Value: cannot exceed 7 digits and must be greater than the low interval value.

SETUP, CONT.

Intervals:, Cont.

Middle Interval Decimal:

This is the number of decimal places for the middle interval value. If the setting displayed is acceptable, press the ▼ Down Arrow to advance to the Middle Interval Capacity: parameter.

If the current setting is not acceptable, use the numeric keys to enter the middle interval decimal places and press the ▼ Down Arrow to advance to the Middle Interval Capacity: parameter.

Allowable values are 0 to 4.

0 = ##### 1 = #####.# 2 = #####.## 3 = #####.### 4 = ###.####

Middle Interval Capacity:

This is the weight capacity for the middle interval. If the setting displayed is acceptable, press the ▼ Down Arrow to advance to the High Interval Value: parameter.

If the current setting is not acceptable, use the numeric keys to enter the weight capacity for the middle interval and press the ▼ Down Arrow to advance to the High Interval Value: parameter.

Note that the value entered cannot exceed 7 digits and must be less than the overall capacity and greater than the low capacity.

High Interval Value:

This is the high interval value. If the setting displayed is acceptable, press the ▼ Down Arrow to advance to the High Interval Decimal: parameter.

If the current setting is not acceptable, use the numeric keys to enter the high interval weight increment value and press the ▼ Down Arrow to advance to the High Interval Decimal: parameter.

Note that the value entered for the High Interval Value: cannot exceed 7 digits and must be greater than the middle interval value.

High Interval Decimal:

This is the number of decimal places for the high interval value. If the setting displayed is acceptable, press the **ENTER** key to save the setting.

The display will change to show Setting Parameters and then Setting Multi-Interval in the upper left corner and return to the **Scale 1 - Calibration Options** screen.

If the current setting is not acceptable, use the numeric keys to enter the high interval decimal places and press the **ENTER** key to save the new setting.

Allowable values are 0 to 4.

0 = ##### 1 = #####.# 2 = #####.## 3 = #####.### 4 = ###.####

The display will change to show Setting Parameters and then Setting Multi-Interval in the upper left corner and return to the **Scale 1 - Calibration Options** screen.

SETUP, CONT.

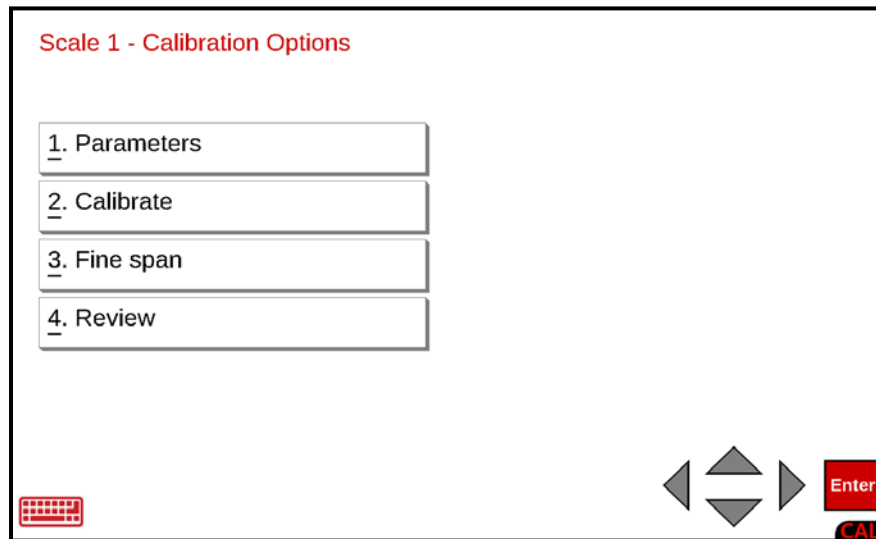
Calibration Methods

The 825 has two methods to enter the calibration procedure. One method is performed after entering the calibration setup parameters. The other method is selected from the **Setup Menu** screen and skips entering the calibration setup parameters.

Calibration of the scale can be performed using up to four calibration points in addition to the zero (no load) weight. The number of calibration points is determined by the **Num Cal Pts:** parameter. When one point is used, only screen prompts for Weight 1 and Weight 2 will be displayed. If more than one point is used, additional screen prompts for Weight 3, Weight 4 and Weight 5 will be displayed.

Note that one weight must be zero (no load) weight.

Calibration after Entering Scale Parameters



2. Calibrate

With the **Scale 1 - Calibration Options** screen displayed, press the 2. Calibrate menu option or use the Qwerty keyboard and press the **2** key to select 2. Calibrate, or use the Navigation Keys to select (highlight) 2. Calibrate and press the **ENTER** key. The display will change to show the **Scale 1 - Calibration Weight 1** screen.

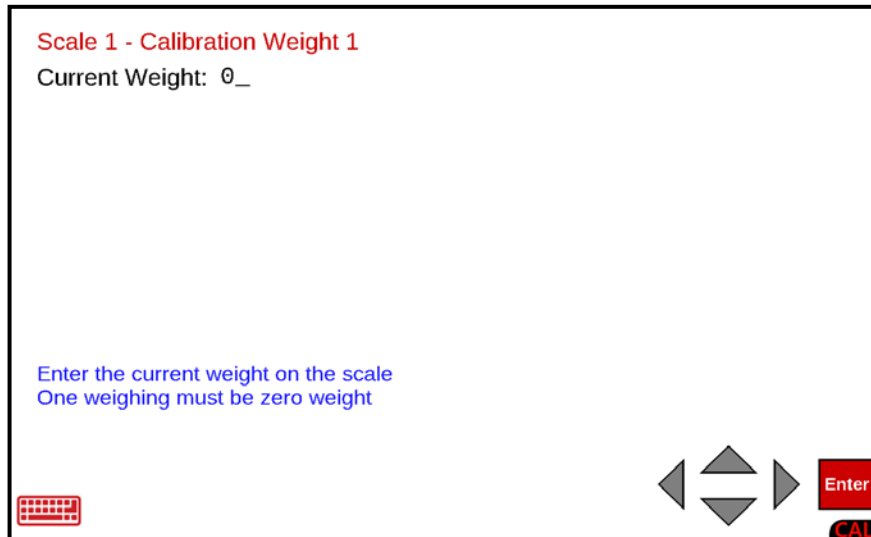
SETUP, CONT.

Calibration after Entering Scale Parameters, Cont.

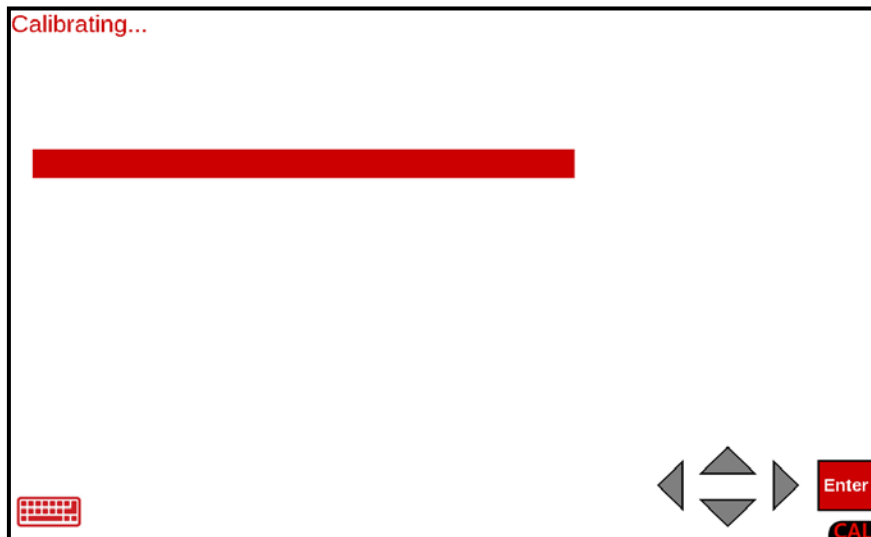
NOTE: The following instructions use two calibration points in addition to the zero (no load) weight. These two points could correspond to a mid-point weight and the test (load) weight. In the examples shown, Weight 1 is zero (no load), Weight 2 is the mid-point weight, and Weight 3 is the test (load) weight.

Calibration Weight 1

1. If this is the zero weight (no load), ensure there is zero weight (no load) on the scale and then using the numeric keys enter a **0** and press the **ENTER** key.
2. Otherwise, place the weight on the scale, and then using the numeric keys, enter the current weight on the scale and press the **ENTER** key.



3. The display will change to show **Calibrating...** and a bar graph proceeding from left to right will be shown. When this step has been completed, the display will change to show the **Scale 1 - Calibration Weight 2** screen.

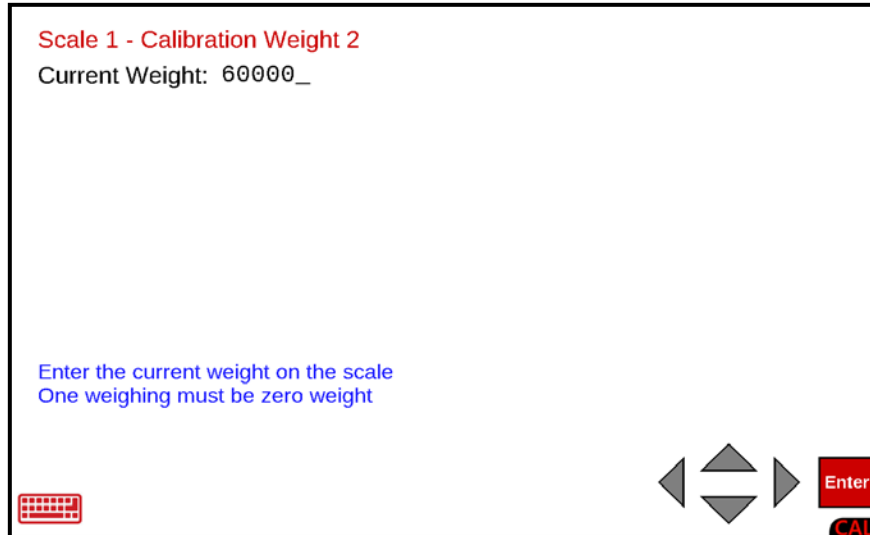


SETUP, CONT.

Calibration after Entering Scale Parameters, Cont.

Calibration Weight 2

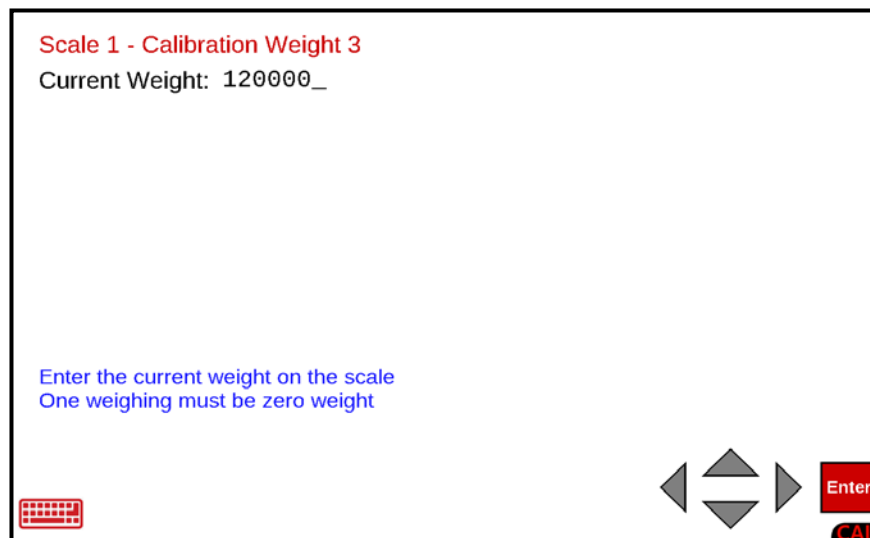
1. Place the mid-point weight on the scale and then using the numeric keys, enter the current weight on the scale and press the **ENTER** key
2. Otherwise, if this is the zero weight (no load), ensure there is zero weight (no load) on the scale and then using the numeric keys enter a **0** and press the **ENTER** key.



3. The display will change to show Calibrating... and a bar graph proceeding from left to right will be shown. When this step has been completed, the display will change to show the **Scale 1 - Calibration Weight 3** screen.

Calibration Weight 3

1. Place the test (load) weight on the scale and then using the numeric keys, enter the current weight on the scale and press the **ENTER** key
2. Otherwise, if this is the zero weight (no load), ensure there is zero weight (no load) on the scale and then using the numeric keys enter a **0** and press the **ENTER** key.



SETUP, CONT.

Calibration after Entering Scale Parameters, Cont.

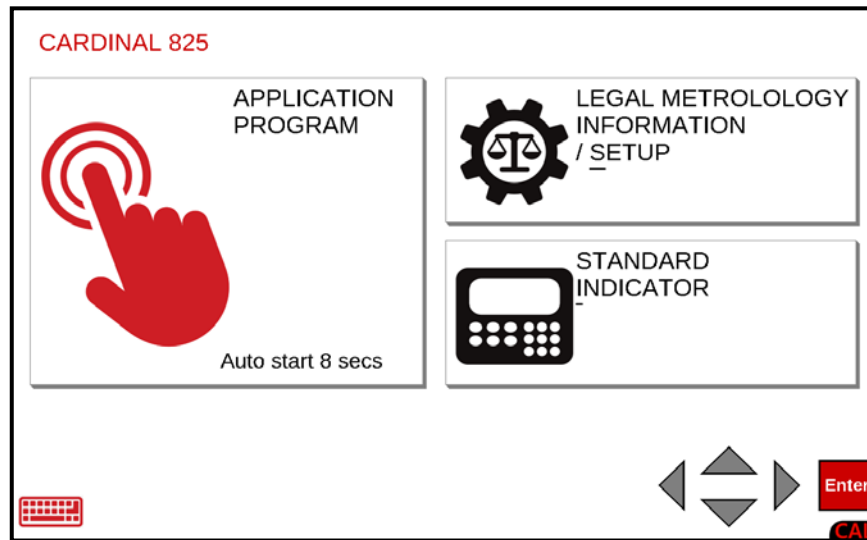
Calibration Weight 3, Cont.

3. The display will change to show Calibrating... and a bar graph proceeding from left to right will be shown. When this step has been completed, the display will change to show the **Scale 1 - Fine Span** screen.

NOTE: If Fine Span adjustment is desired, proceed to the Fine Span Adjustment section following the **Calibration from the Setup Menu** section.

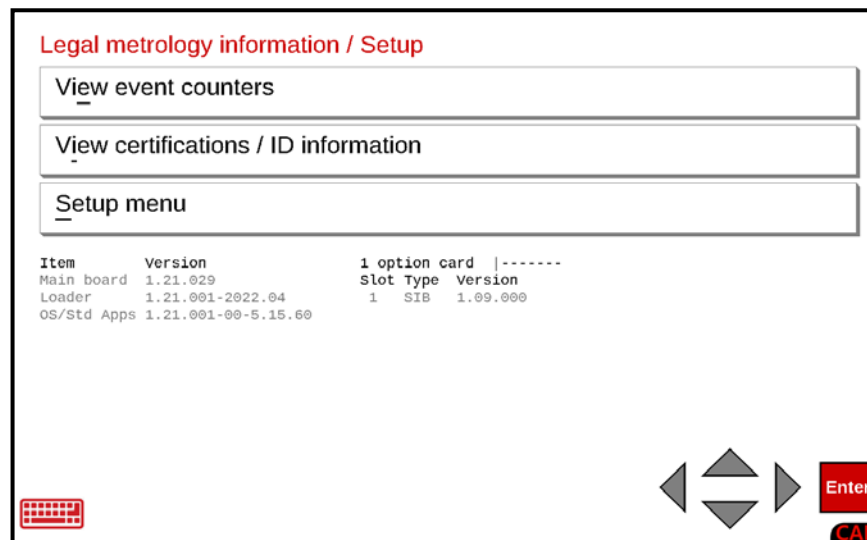
SETUP, CONT.

Calibration from the Setup Menu



With the **Start-Up** screen displayed, press the **LEGAL METROLOGY INFORMATION / SETUP** selection on the touchscreen or use the Qwerty keyboard and press the **S** key to select **LEGAL METROLOGY INFORMATION / SETUP** or use the Navigation Keys ► Right Arrow to (highlight) the selection and press the **ENTER** key.

The display will change to show the **Legal metrology information / Setup** screen.

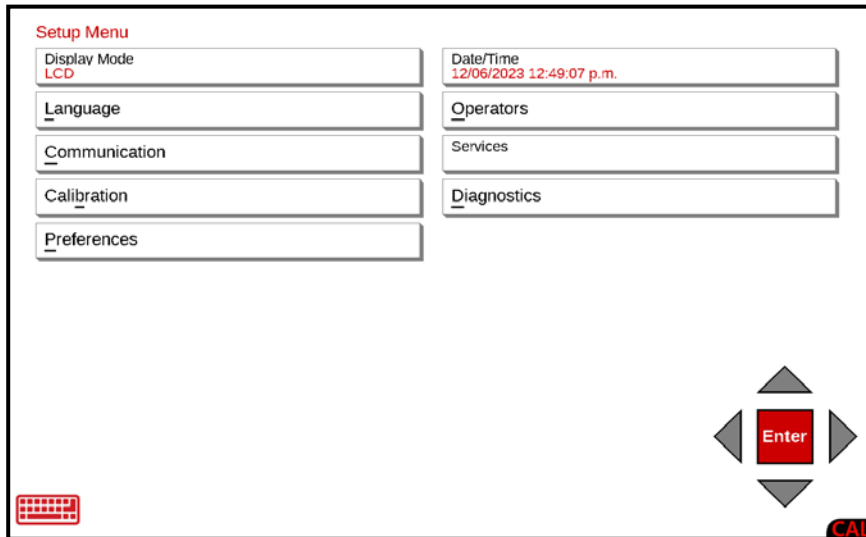


With the **Legal metrology information / Setup** screen displayed, press the **Setup menu** selection on the touchscreen or use the Qwerty keyboard and press the **S** key to select the **Setup menu** or use the Navigation Keys ► Right Arrow to (highlight) the selection and press the **ENTER** key.

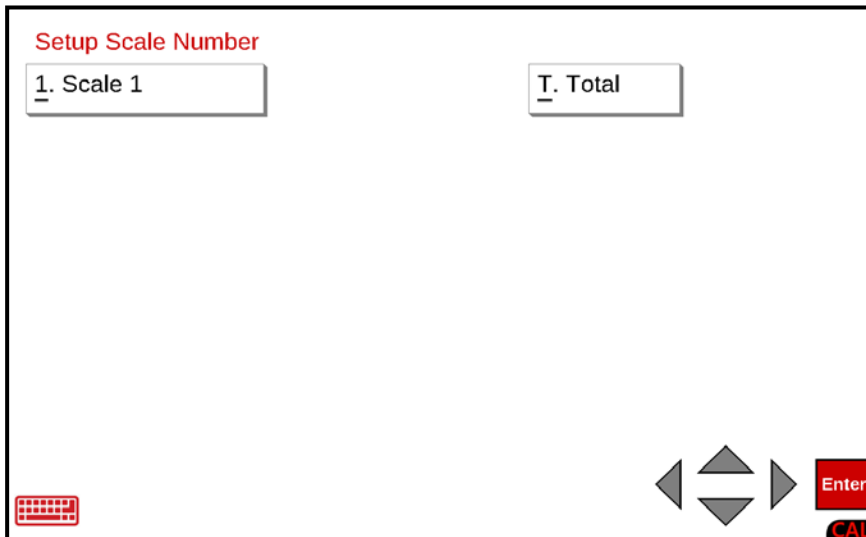
The display will change to show the **Setup Menu** screen.

SETUP, CONT.

Calibration from the Setup Menu, Cont.



With the **Setup Menu** screen displayed, press the Calibration menu option, or use the Qwerty keyboard and press the **b** key to select Calibration, or use the Navigation Keys to select (highlight) Calibration and press the **ENTER** key. The display will change to show the **Setup Scale Number** screen.

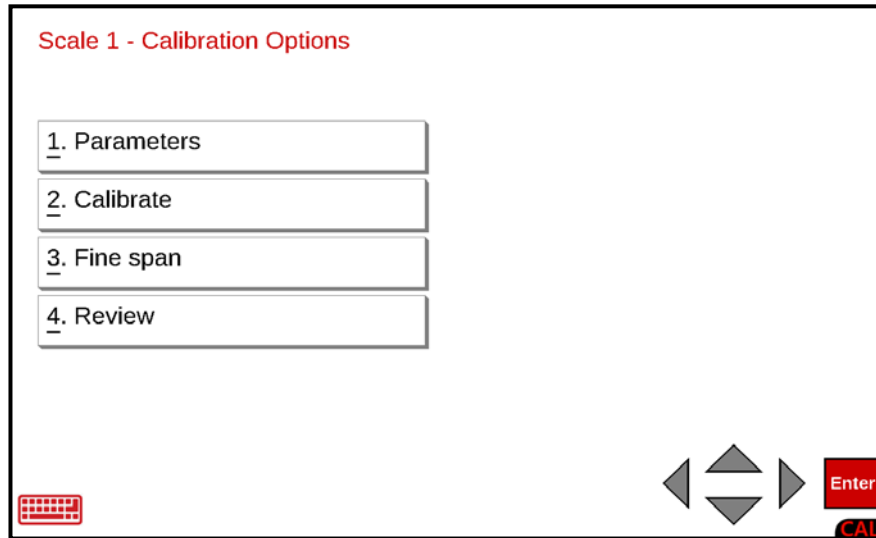


Setup Scale Number:

With the **Setup Scale Number** screen displayed, press the 1. Scale 1 menu option or use the Qwerty keyboard and press the **1** key to select Scale 1 or use the Navigation Keys to select (highlight) Scale 1 and press the **ENTER** key. The display will change to show the **Scale 1 - Calibration Options** screen.

SETUP, CONT.

Calibration from the Setup Menu, Cont.

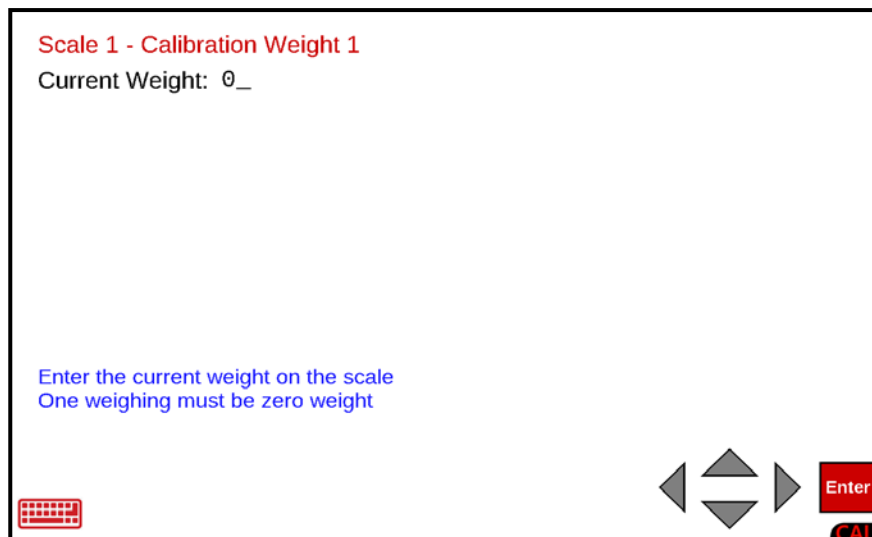


2. Calibrate

With the **Scale 1 - Calibration Options** screen displayed, press the 2. Calibrate menu option or use the Qwerty keyboard and press the **2** key to select 2. Calibrate, or use the Navigation Keys to select (highlight) 2. Calibrate and press the **ENTER** key. The display will change to show the **Scale 1 - Calibration Weight 1** screen.

Calibration Weight 1

1. If this is the zero weight (no load), ensure there is zero weight (no load) on the scale and then using the numeric keys enter a **0** and press the **ENTER** key.
2. Otherwise, place the weight on the scale and then using the numeric keys, enter the current weight on the scale and press the **ENTER** key.

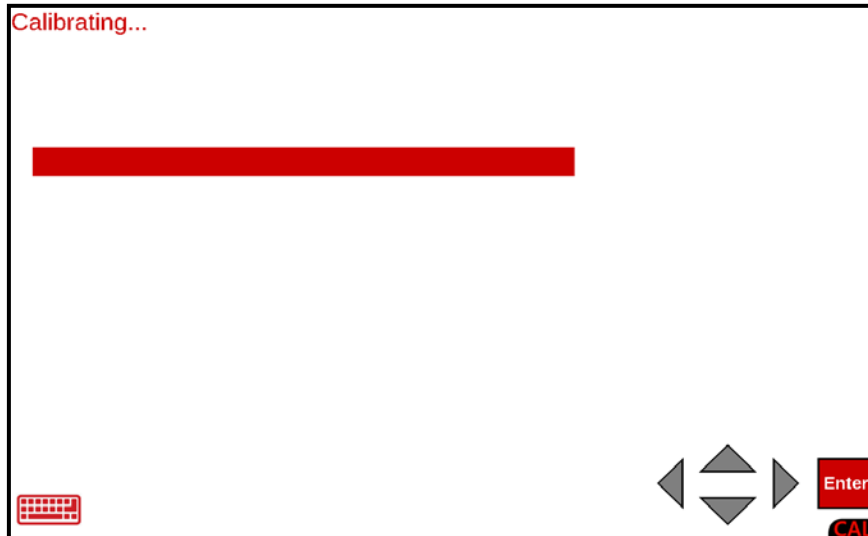


SETUP, CONT.

Calibration from the Setup Menu, Cont.

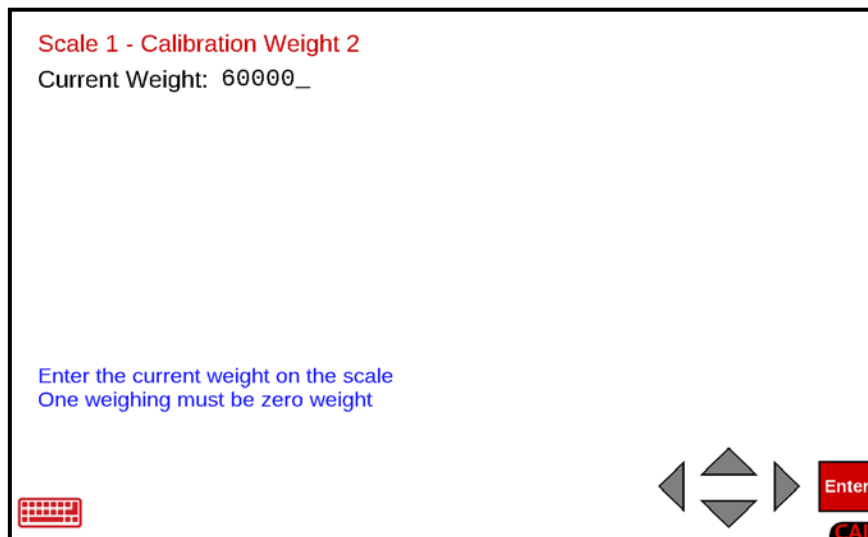
Calibration Weight 1, Cont.

3. The display will change to show Calibrating... and a bar graph proceeding from left to right will be shown. When this step has been completed, the display will change to show the **Scale 1 - Calibration Weight 2** screen.



Calibration Weight 2

1. Place the mid-point weight on the scale and then using the numeric keys, enter the current weight on the scale and press the **ENTER** key
2. Otherwise, if this is the zero weight (no load), ensure there is zero weight (no load) on the scale and then using the numeric keys enter a **0** and press the **ENTER** key.



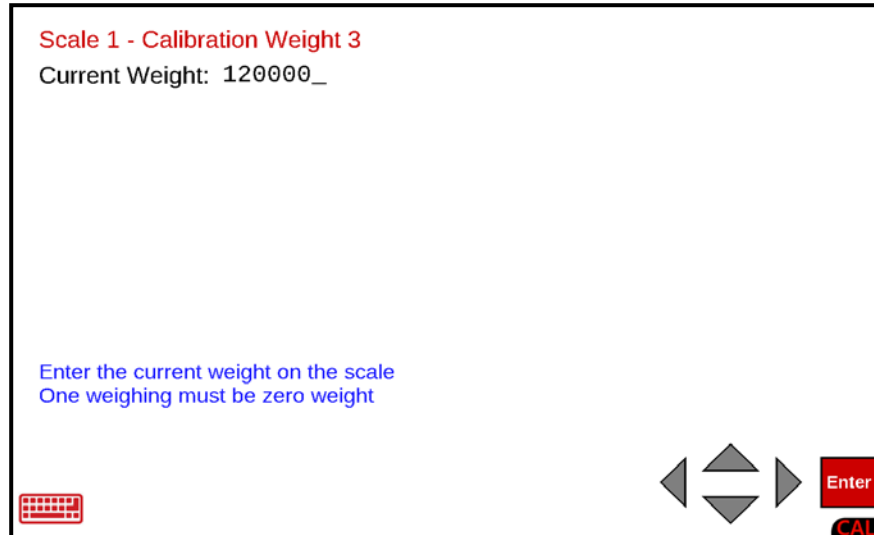
3. The display will change to show Calibrating... and a bar graph proceeding from left to right will be shown. When this step has been completed, the display will change to show the **Scale 1 - Calibration Weight 3** screen.

SETUP, CONT.

Calibration from the Setup Menu, Cont.

Calibration Weight 3

1. Place the test (load) weight on the scale and then using the numeric keys, enter the current weight on the scale and press the **ENTER** key
2. Otherwise, if this is the zero weight (no load), ensure there is zero weight (no load) on the scale and then using the numeric keys enter a **0** and press the **ENTER** key.



3. The display will change to show **Calibrating...** and a bar graph proceeding from left to right will be shown. When this step has been completed, the display will change to show the **Scale 1 - Fine Span** screen.

NOTE: If Fine Span adjustment is desired, proceed to the next section of this manual.

SETUP, CONT.

Fine Span Adjustment

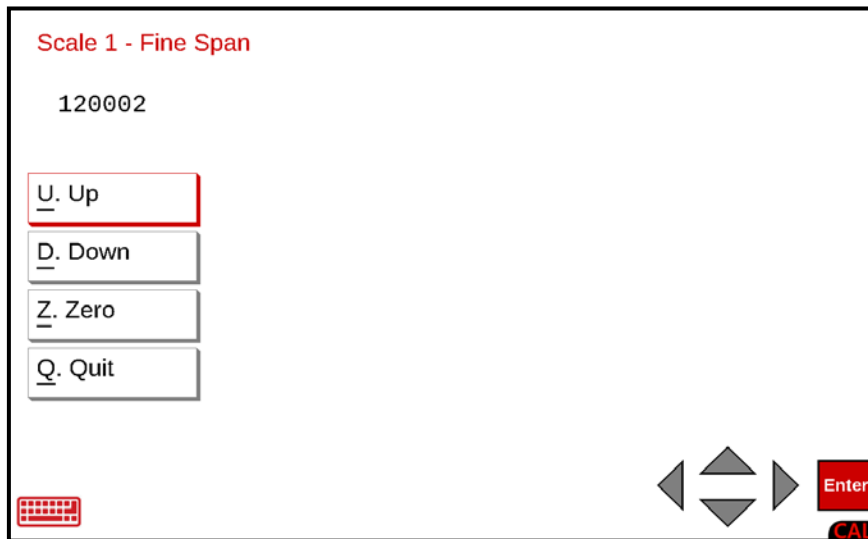
The 825 has three methods to enter the fine span adjustment. All three methods perform the same function, only the method to enter the fine span adjustment is different.

One method is performed after entering the calibration setup parameters, the second method is performed after completing the calibration procedure when calibration has been selected from the **Setup Menu** screen, and the third method is to select the 3. Fine Span menu option from the **Scale 1 – Calibration Options** screen.

To select Fine Span from the **Scale 1 – Calibration Options** screen, press the 3. Fine Span menu option or use the Qwerty keyboard and press the **3** key to select 3. Fine Span or use the Navigation Keys to select (highlight) 3. Fine Span and press the **ENTER** key. The display will change to show the **Scale 1 - Fine Span** screen.

Scale 1 - Fine Span

NOTE: Use the Calibration Weight 3 test (load) weight already on the scale or place a calibrated test weight on the scale.



With the **Scale 1 - Fine Span** screen displayed, press the onscreen menu option to perform the desired fine span adjustment or use the Navigation Keys to select (highlight) the fine span adjustment option and press the **ENTER** key to perform the function.

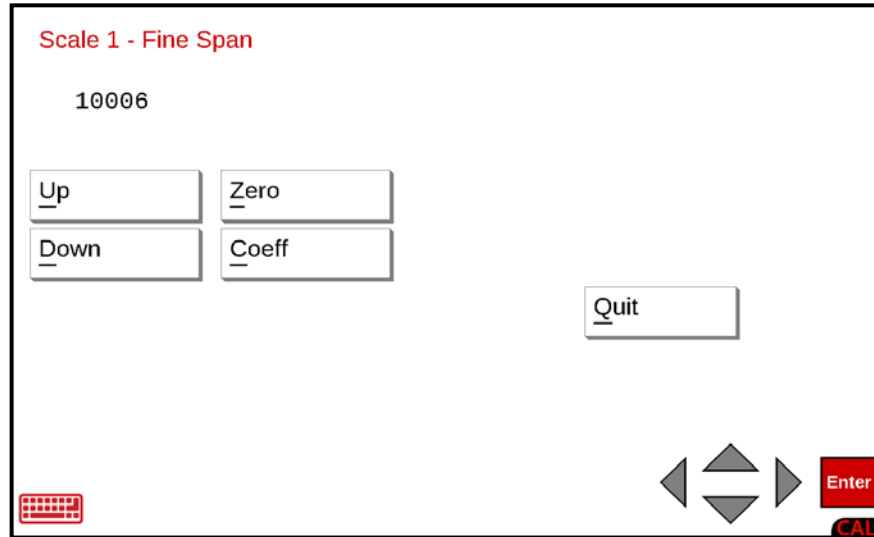
Otherwise, use the Qwerty keyboard and press the appropriate letter to perform the fine span adjustment function.

- Press the **U** key (U. Up) to increase the displayed weight.
- Press the **D** key (D. Down) to decrease the displayed weight,
- Press the **Z** key (Z. Zero) to zero the scale.
- Press the **Q** key (Q. Quit) to save the current settings and Quit.

SETUP, CONT.

Fine Span Adjustment with 2nd Order Linearization

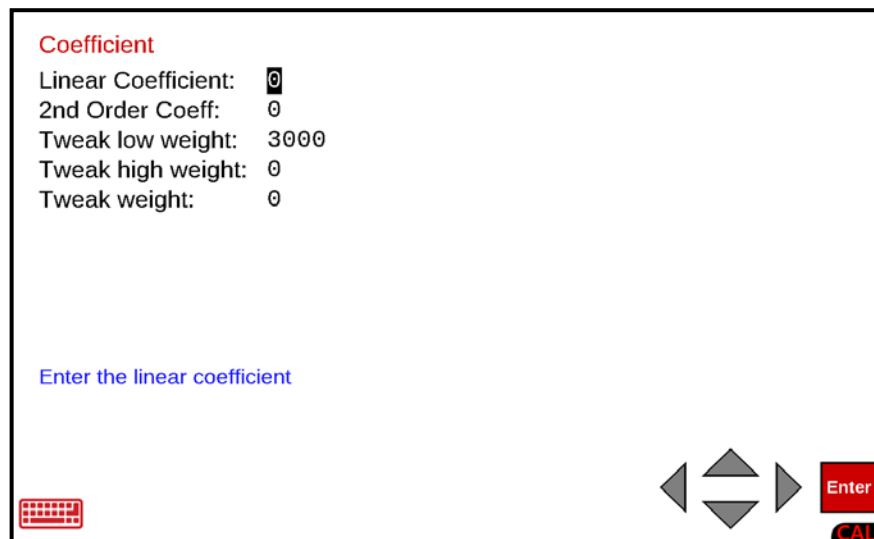
If 2nd Order Linearization is enabled and the Num Cal Pts parameter is set for 2 or more, then a **COEFF** option will be added to the **Fine Span** screen. This option is used to adjust the displayed weight after linearization testing has shown an error in a specific range of weight.



Scale 1 - Fine Span

NOTE: Use the Calibration Weight 3 test (load) weight already on the scale or place a calibrated test weight on the scale.

With the **Scale 1 - Fine Span** screen displayed, press the Coeff menu selection on the touchscreen, or use the Qwerty keyboard and press the **C** key to select the Coeff menu selection or use the Navigation Keys to select (highlight) the Coeff menu selection and press the **ENTER** key to proceed to the **Coefficient** screen.



SETUP, CONT.

Linear Coefficient:

The Linear Coefficient is applied to the load cell signal to calculate weight.

With the **Coefficient** screen displayed the current setting for the Linear Coefficient: parameter will be shown. If the current setting displayed is acceptable, press the ▼ Down Arrow to advance to the next parameter.

If the current setting is not acceptable, use the numeric keys to enter a new Linear Coefficient and press the ▼ Down Arrow to advance to the 2nd Order Coeff: parameter.

2nd Order Coeff:

This 2nd Coeff is applied to the square of the load cell signal to calculate the weight.

With the **Coefficient** screen displayed the current setting for the 2nd Order Coeff: parameter will be shown. If the current setting displayed is acceptable, press the ▼ Down Arrow to advance to the next parameter.

If the current setting is not acceptable, use the numeric keys to enter a new 2nd Order Coeff and press the ▼ Down Arrow to advance to the Tweak low weight: parameter.



WARNING! Changing the Linear Coefficient or the 2nd Order Coeff will affect the indicator's ability to display the proper weight. Please consult the factory before making any changes.

Tweak low weight:

This is the low end of the range of weight that requires adjusting. For example, if after performing linearization testing, the displayed weight is 5 lb low between 10,000 lb and 15,000 lb, the value for the tweak low weight is 10000.

With the **Coefficient** screen displayed the current setting for the Tweak low weight: parameter will be shown. If the current setting displayed is acceptable, press the ▼ Down Arrow to advance to the next parameter.

If the current setting is not acceptable, use the numeric keys to enter the Tweak low weight and press the ▼ Down Arrow to advance to the next parameter.

SETUP, CONT.

Tweak high weight:

This is the high end of the range of weight that requires adjusting. Using the example above, the value for the Tweak high weight is 15000.

With the **Coefficient** screen displayed the current setting for the Tweak high weight: parameter will be shown. If the current setting displayed is acceptable, press the ▼ Down Arrow to advance to the next parameter.

If the current setting is not acceptable, use the numeric keys to enter the Tweak high weight and press the ▼ Down Arrow to advance to the Tweak weight: parameter.

Tweak weight:

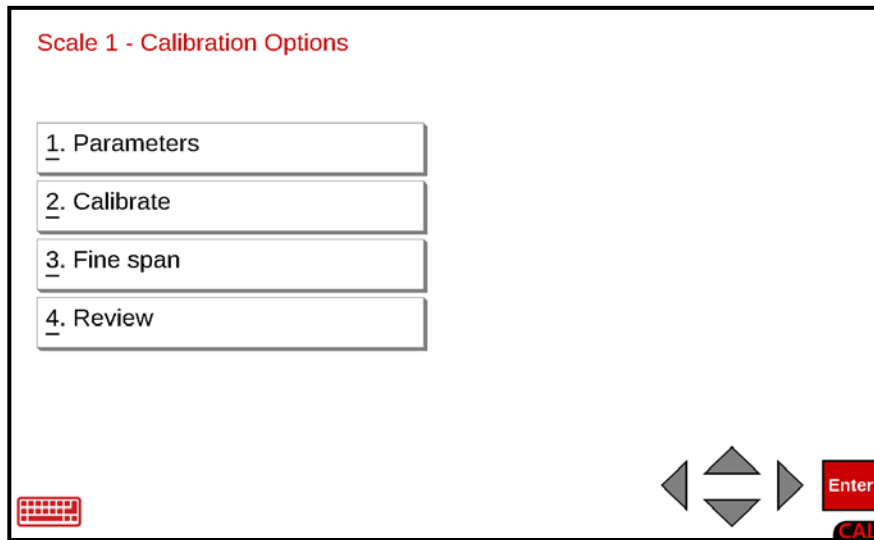
This is the amount of weight that needs to be added (or subtracted) from the range of weight to bring the displayed weight into tolerance. Again, using the example above, the Tweak Weight would be 5.

With the **Coefficient** screen displayed the current setting for the Tweak weight: parameter will be shown. If the current setting displayed is acceptable, press the **ENTER** key to save the settings and return to the **Scale 1 - Fine Span** screen.

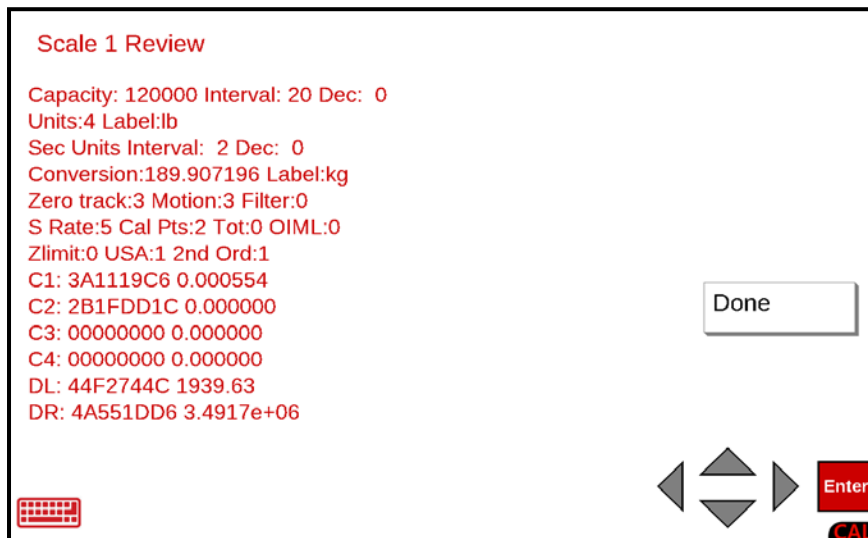
If the current setting is not acceptable, use the numeric keys to enter a new Tweak weight and press the **ENTER** key to save the settings, and return to the **Scale 1 - Fine Span** screen.

SETUP, CONT.

Review Setup Parameters



With the **Scale 1 - Calibration Options** screen displayed, press the 4. Review menu option or use the Qwerty keyboard and press the **4** key to select 4. Review or use the Navigation Keys to select (highlight) 4. Review and press the **ENTER** key. The display will change to show the **Scale 1 Review** screen.



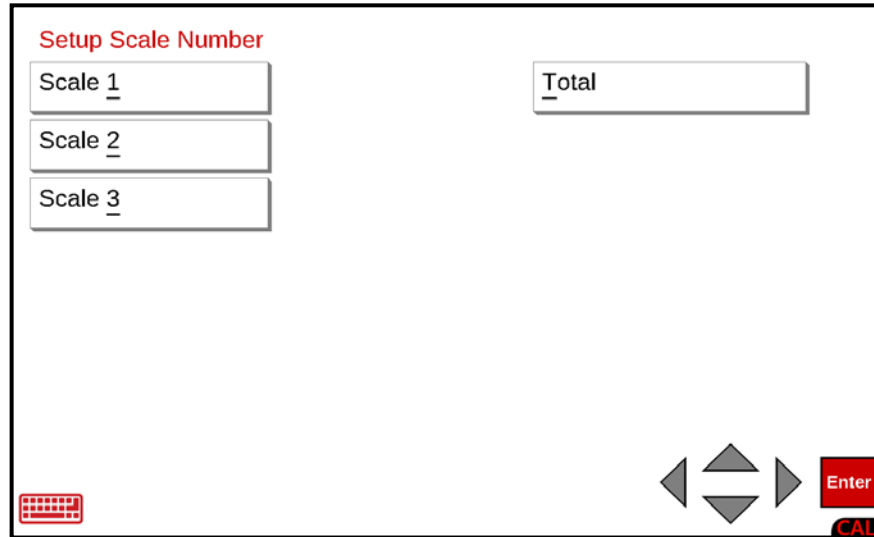
After viewing the Scale 1 parameters, press **Done** or **Enter** on the touchscreen, or use the Navigation Keys ◀ Left Arrow or use the Qwerty keyboard **Esc** key to exit viewing and return to the **Scale 1 - Calibration Options** screen.

SETUP, CONT.

Totalizer Function

The Totalizer function will sum the weights of two or more scales and make the total available to the application program. The Totalizer can be referenced as if it were another scale.

With the **Setup Menu** screen displayed, press the Calibration menu option, or use the Qwerty keyboard and press the **b** key to select Calibration, or use the Navigation Keys to select (highlight) Calibration and press the **ENTER** key. The display will change to show the **Setup Scale Number** screen.



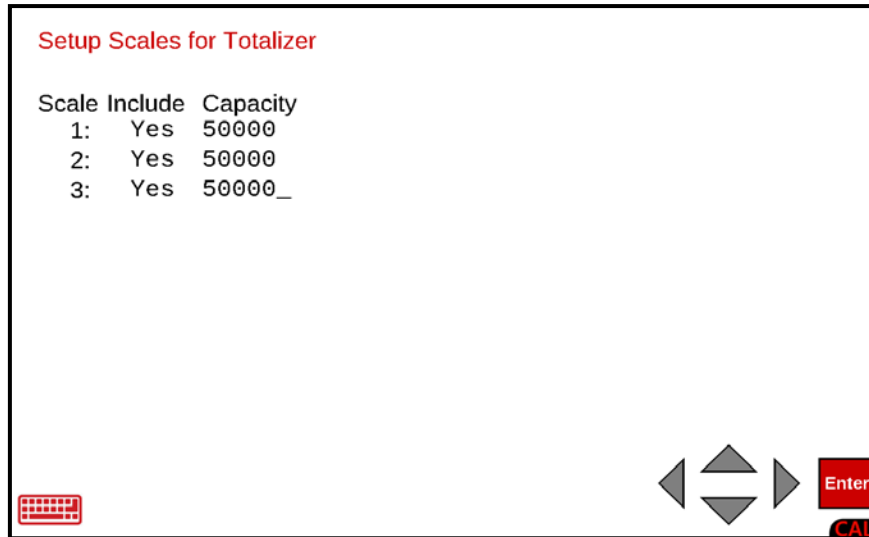
Total

With the **Setup Scale Number** screen displayed, press the Total menu option, or use the Qwerty keyboard and press the **T** key to select Total, or use the Navigation Keys to select (highlight) Total and press the **ENTER** key. The display will change to show the **Setup Scales for Totalizer** screen.



SETUP, CONT.

Total, Cont.



Scale Include and Capacity

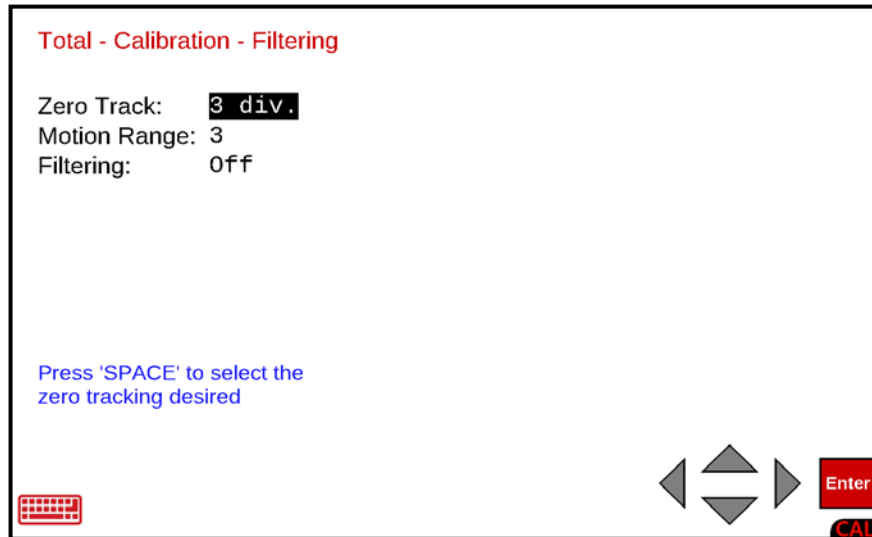
With the **Setup Scales for Totalizer** screen displayed the current setting for each scale will be shown. If the setting displayed is acceptable, press the **ENTER** key to proceed to the next parameter or use the Navigation Keys ◀ Left Arrow to return to the **Setup Scale Number** screen.

If the current setting is not acceptable, press the **SPACE** key to **Include** the first scale (toggle from No to Yes) and press the ▶ Right Arrow to advance to the Capacity setting. Use the numeric keys to enter the scale capacity and press the ▼ Down Arrow to proceed to the next scale.

Repeat the above steps for each scale to be included in the Totalize and press the **ENTER** key to save the new settings and proceed to the next parameter.

SETUP, CONT.

Total - Calibration - Filtering



Zero Track:

With the **Total - Calibration - Filtering** screen displayed the current setting for the Zero Track: parameter will be shown. If the setting displayed is acceptable, press the ▼ Down Arrow to advance to the next parameter.

If the current setting is not acceptable, press the **SPACE** key to step through and select the zero tracking range, and press the ▼ Down Arrow to advance to the next parameter, or press the **ENTER** key to save the new setting and proceed to the **Total - Calibration - Options** screen.

Available selections are Off, 0.5 div, and 1 through 9 div.

Off 0.5 div 1 div 2 div 3 div 4 div 5 div 6 div 7 div 8 div 9 div

Motion Range:

With the **Total - Calibration - Filtering** screen displayed the current setting for the **Motion Range:** parameter will be shown. If the setting displayed is acceptable, press the ▼ Down Arrow to advance to the next parameter.

If the current setting is not acceptable, use the numeric keys to enter the motion range (the number of divisions of change permitted before indicating unstable) and press the ▼ Down Arrow to advance to the next parameter or press the **ENTER** key to save the new setting and proceed to the **Total - Calibration - Options** screen.

Allowable values are **0** to **9**.

NOTE: Entering zero (**0**) will disable the motion range.

SETUP, CONT.

Filtering:

With the **Total - Calibration - Filtering** screen displayed the current setting for the **Filtering:** parameter will be shown. If the setting displayed is acceptable, press the **ENTER** key to save the new setting and proceed to the **Total - Calibration - Options** screen.

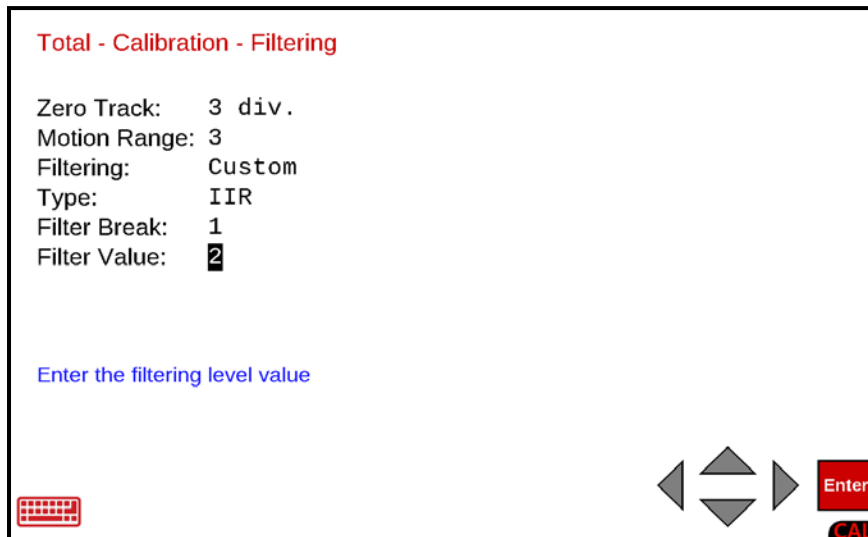
If the current setting is not acceptable, press the **SPACE** key to step through and select the digital filtering, and press the **ENTER** key to save the new setting and proceed to the **Total - Calibration - Options** screen.

Allowable selections are **Off**, **Minimal**, **Moderate**, and **Custom**.

- Off** Disabled (No Filtering)
- Minimal** Minimal Filtering (Sample Rate automatically set to 2)
- Moderate** Moderate Filtering (Sample Rate automatically set to 1)
- Custom** Custom Filtering (Additional Parameters displayed, data entry required)

NOTE: If Custom is selected for Filtering: additional parameters, Type:, Filter Break:, and Filter Value: will be shown (below the Filtering: parameter) and requires data to be entered. Proceed to the Custom Filtering: parameter.

Custom Filtering:



Type:

With Custom selected for Filtering:, the current setting for the Type: parameter will be shown. If the setting displayed is acceptable, press the ▼ Down Arrow to advance to the next parameter or press the **ENTER** key to save the new setting and proceed to the **Total - Calibration - Options** screen.

SETUP, CONT.

Custom Filtering:, Cont.

Type:, Cont.

If the current setting for Type: is not acceptable, press the **SPACE** key to toggle between the selections and press the ▼ Down Arrow to advance to the next parameter or press the **ENTER** key to save the new setting and proceed to the **Total - Calibration - Options** screen.

Allowable selections are **IIR** or **FIR**.

IIR (Infinite Impulse Response) - Same as previous custom filtering.

FIR (Finite Impulse Response) - Better for high sample rates, and high-speed weighing.

Filter Break:

The filter break range is a number from 1 to 64 that corresponds to the number of division changes to break out of the filtering.

With Custom selected for Filtering:, the current setting for the Filter Break: parameter will be shown. If the setting displayed is acceptable, press the ▼ Down Arrow to advance to the next parameter or press the **ENTER** key to save the new setting and proceed to the **Total - Calibration - Options** screen.

If the current setting is not acceptable, use the numeric keys to enter the value for the filter break range and press the ▼ Down Arrow to advance to the next parameter or press the **ENTER** key to save the new setting and proceed to the **Total - Calibration - Options** screen.

Allowable values are **1** to **64**.

Filter Value:

The filter value is a number from 1 to 255 that corresponds to the level of filtering with 255 being the greatest filtering and 1 the least.

With Custom selected for Filtering:, the current setting for the Filter Value: parameter will be shown. If the setting displayed is acceptable, press the **ENTER** key to save the setting and proceed to the **Total - Calibration - Options** screen.

If the current setting is not acceptable, use the numeric keys to enter the value for the filter value and press the **ENTER** key to save the setting, and proceed to the **Total - Calibration - Options** screen.

Allowable values are **1** to **255**.

SETUP, CONT.

Total - Calibration - Options

Total - Calibration - Options

Sample Rate: 5
Num Cal Pts: 1
OIML: No

Enter the number of samples per second.
Automatically set to 2 for filter
setting 1, or 1 for filter setting 2.

Enter

CAL

Sample Rate:

With the **Total - Calibration - Options** screen displayed the current setting for the Sample Rate: parameter will be shown. If the setting displayed is acceptable, press the ▼ Down Arrow to advance to the next parameter.

If the current setting is not acceptable, use the numeric keys to enter the sample rate in samples per second and press the ▼ Down Arrow to advance to the next parameter, or press the **ENTER** key to save the new setting and proceed to the **Total - Calibration – Other - Options** screen.

Allowable values are 1 to 200.

NOTE: The Sample Rate: will automatically be set to 2 when Minimal Filtering: has been selected, or at 1 when Moderate Filtering has been selected.

Num Cal Pts:

Calibration of the scale can be performed using multiple calibration points to obtain a more precise weight reading over the entire span of the scale. The Num Cal Pts: parameter is used to select the number of calibration points in addition to the zero (no load) weight calibration point. **DO NOT** include the zero (no load) weight calibration point when selecting the number of calibration points. For example, by selecting 2 for Num Cal Pts:, you would have a total of three calibration points, zero (no load) weight, and two calibration points that could correspond to a mid-point weight and the test (load) weight.

With the **Total - Calibration - Options** screen displayed the current setting for the Num Cal Pts: parameter will be shown. If the setting displayed is acceptable, press the ▼ Down Arrow to advance to the next parameter.

If the current setting is not acceptable, use the numeric keys to enter a new number of calibration points and press the ▼ Down Arrow to advance to the next parameter or press the **ENTER** key to save the new setting and proceed to the **Total - Calibration - Other Options** screen.

Allowable values are 1 to 4.

SETUP, CONT.

OIML:

This parameter determines whether the indicator will be used in an application requiring OIML (International Organization of Legal Metrology) compliance.

With the **Total - Calibration - Options** screen displayed the current setting for the OIML: parameter will be shown. If the setting displayed is acceptable, press the **ENTER** key to save the setting and proceed to the **Total - Calibration - Other Options** screen, or use the Navigation Keys ◀ Left Arrow to return to the **Total - Calibration - Filtering** screen.

If the current setting is not acceptable, press the **SPACE** key to toggle the setting between Yes and No.

- Select **Yes** to enable OIML compliance and press the **ENTER** key to save the setting and proceed to the **Total - Calibration - Other Options** screen.

With Yes selected:

- a. Manual Tare Entry (PT is displayed and printed)
 - b. Single Interval weight displays:
 - Max (Maximum Capacity)
 - Min (Minimum Capacity)
 - e (Scale Interval)
- Select **No** to disable OIML compliance and press the **ENTER** key to save the setting and proceed to the **Total - Calibration - Other Options** screen.

With No: selected:

- a. Manual Tare Entry (MAN WT is displayed and printed)
- b. Single Interval weight displays:
 - Scale Capacity and Interval

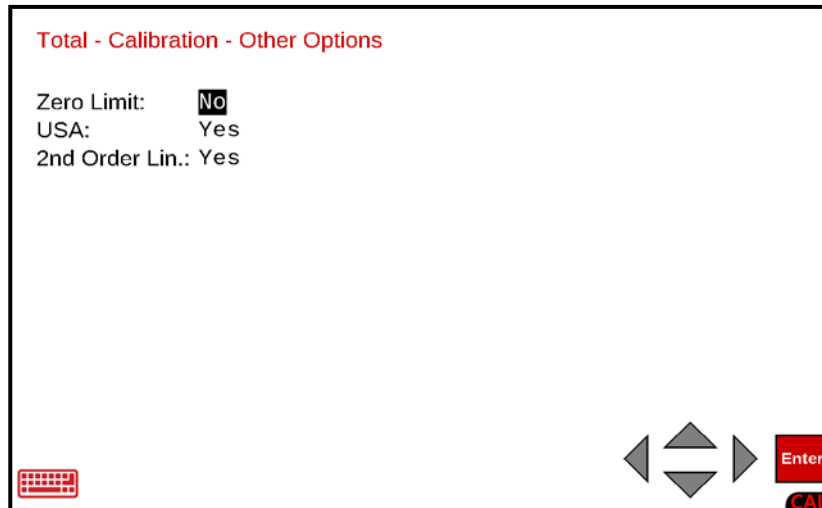


IMPORTANT! Selecting Yes meets International Organization of Legal Metrology (OIML) compliance.

- When **Yes** is selected, serial Comm Port 3 will be dedicated to outputting the scale gross weight whenever the application program is executing. The application program cannot manipulate this output in any way.
- The serial Comm Port 3 communications parameters will default to 9600 baud, 8 data bits, no parity bits, and 1 stop bit.
- The data will be sent out at a rate of 2 times per second.
- Note that the serial Comm Port 3 communication parameters can be changed in the **Communication Menu, Setup Com port 3** screen.

SETUP, CONT.

Total - Calibration - Other Options



Zero Limit:

With the **Total - Calibration - Other Options** screen displayed the current setting for the Zero Limit: parameter will be shown. If the setting displayed is acceptable, press the ▼ Down Arrow to advance to the next parameter.

If the current setting is not acceptable, press the **SPACE** key to toggle the setting between Yes and No.

- Select **Yes** to enable the Zero Limit and press the ▼ Down Arrow to advance to the next parameter. Note that selecting **Yes** will limit the push button zero and zero tracking to $\pm 2\%$ of the scale capacity.
- Select **No** to disable the Zero Limit and press the ▼ Down Arrow to advance to the next parameter. Note that selecting **No** will allow the push button zero and zero tracking to zero up to the full capacity of the scale.

USA:

This parameter selects whether the indicator is used in the USA (domestic) or outside the USA (international).

With the **Total - Calibration - Other Options** screen displayed the current setting for the USA: parameter will be shown. If the setting displayed is acceptable, press the ▼ Down Arrow to advance to the next parameter.

If the current setting is not acceptable, press the **SPACE** key to toggle the setting between Yes and No.

- Select **Yes** to enable USA: and press the ▼ Down Arrow to advance to the next parameter. Note that selecting **Yes** allows Over Capacity up to 104% of scale capacity.
- Select **No** to disable USA: and press the ▼ Down Arrow to advance to the next parameter. Note that selecting **No** will allow the push button zero and zero tracking to zero up to the full capacity of the scale.

SETUP, CONT.

2nd Order Lin:

2nd Order Linearization is a method used to correct for nonlinearity in the load cell signal. An extra term, which is proportional to the square of the load cell signal, is used in the conversion of the load cell signal into a weight value.

With the **Total - Calibration - Other Options** screen displayed the current setting for the 2nd Order Lin: parameter will be shown. If the setting displayed is acceptable, press the **ENTER** key to proceed to the **Total - Calibration - Multi Interval** screen, or use the Navigation Keys ◀ Left Arrow to return to the **Total - Calibration - Other Options** screen.

If the current setting is not acceptable, press the **SPACE** key to toggle the setting between Yes and No.

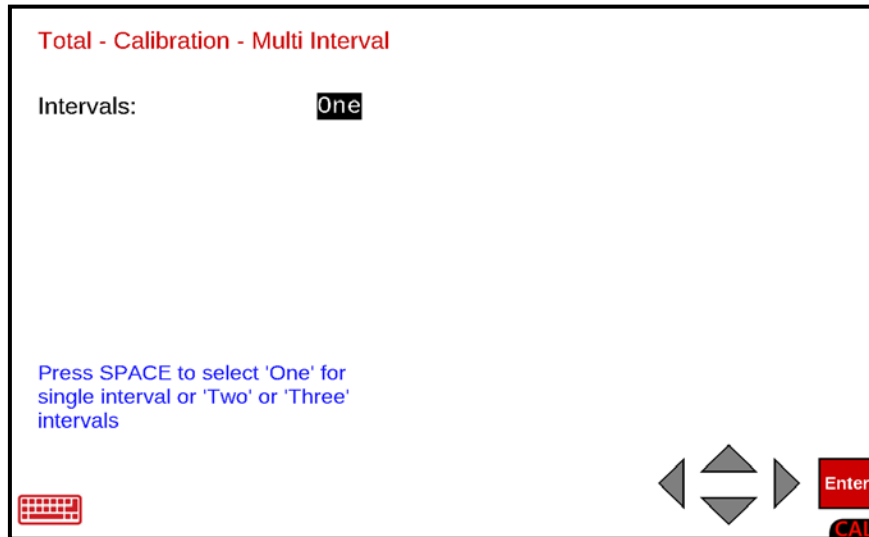
- Select **Yes** to enable 2nd Order Lin: and press the **ENTER** key to proceed to the **Total - Calibration - Multi Interval** screen. Note that when selecting **Yes**, the Fine Span screen will have the additional option **Coeff** added to it.
- Select **No** to disable 2nd Order Lin: and press the **ENTER** key to proceed to the **Scale 1 - Calibration - Multi Interval** screen. Note that when selecting **No**, the Fine Span screen will only have the Up, Down, Zero, and Quit options.



IMPORTANT! For 2nd Order Linearization to take effect, calibration must be performed with at least a total of three calibration points (no load and two load points with different weights). If only two calibration points (no load and load) are used, the **Coeff** option will **NOT** be added to the Fine Span screen.

SETUP, CONT.

Total - Calibration - Multi Interval



Intervals:

With the **Total - Calibration - Multi Interval** screen displayed the current setting for the Intervals: parameter will be shown. If the setting displayed is acceptable, press the **ENTER** key to save the setting.

The display will change to show Setting Parameters and then Setting Multi-Interval in the upper left corner and then change to the **Totalizer** screen.

If the current setting is not acceptable, press the **SPACE** key to step through and select the Interval (number of weight ranges to use).

Allowable selections are **One**, **Two**, or **Three**.

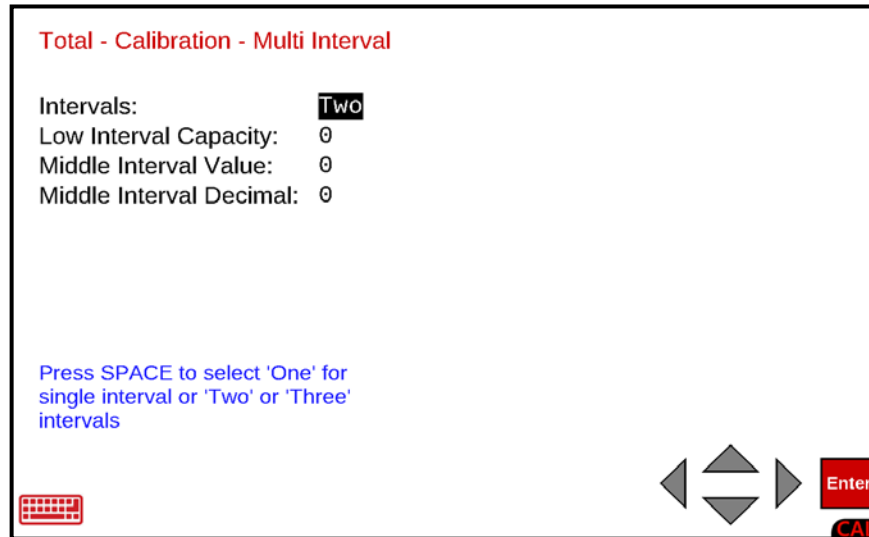
With One selected for Intervals

Select **One** for Single Interval and press the **ENTER** key to save the new setting.

The display will change to show Setting Parameters and then Setting Multi-Interval in the upper left corner and then change to the **Totalizer** screen.

SETUP, CONT.

Intervals:, Cont.



With Two selected for Intervals

If **Two** is selected, three (3) additional parameters will be displayed on the screen. Press the ▼ Down Arrow to advance to the Low Interval Capacity: parameter.

Low Interval Capacity:

This is the weight capacity for the low interval. If the setting displayed is acceptable, press the ▼ Down Arrow to advance to the Middle Interval Value: parameter.

If the current setting is not acceptable, use the numeric keys to enter the capacity for the low interval and press the ▼ Down Arrow to advance to the Middle Interval Value: parameter.

Note that the value entered for Low Interval Capacity cannot exceed 7 digits and must be less than the overall capacity.

Middle Interval Value:

This is the middle interval value. If the setting displayed is acceptable, press the ▼ Down Arrow to advance to the Middle Interval Decimal: parameter.

If the current setting is not acceptable, use the numeric keys to enter the middle interval weight increment value and press the ▼ Down Arrow to advance to the Middle Interval Decimal: parameter.

Note that the value entered for the Middle Interval Value: cannot exceed 7 digits and must be greater than the low interval value.

SETUP, CONT.

Intervals:, Cont.

Middle Interval Decimal:

This is the number of decimal places for the middle interval value. If the setting displayed is acceptable, press the **ENTER** key to save the setting.

The display will change to show Setting Parameters and then Setting Multi-Interval in the upper left corner and then change to the **Totalizer** screen.

If the current setting is not acceptable, use the numeric keys to enter the middle interval decimal places and press the **ENTER** key to save the new setting.

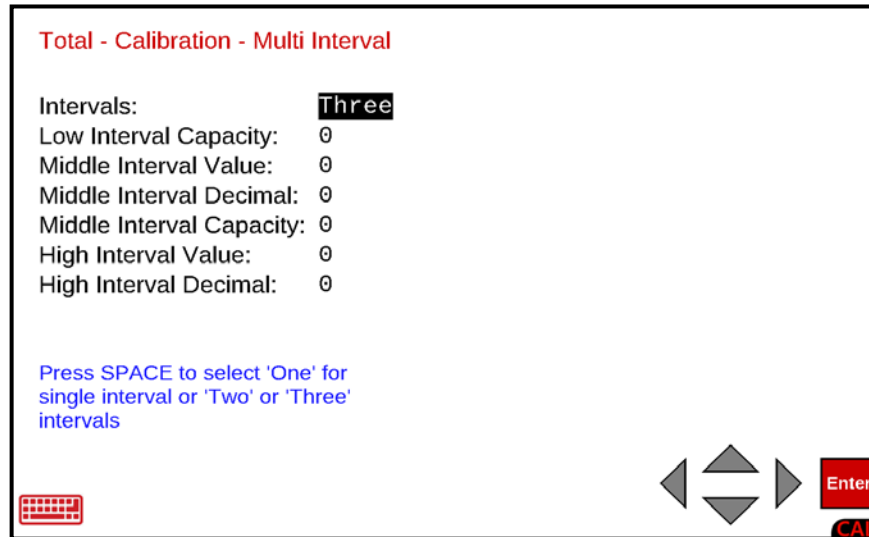
Allowable values are **0** to **4**.

0 = ##### **1 = #####.#** **2 = #####.##** **3 = #####.###** **4 = ###.####**

The display will change to show Setting Parameters and then Setting Multi-Interval in the upper left corner and then change to the **Totalizer** screen.

SETUP, CONT.

Intervals:, Cont.



With Three selected for Intervals

If **Three** is selected, six (6) additional parameters will be displayed on the screen. Press the ▼ Down Arrow to advance to the Low Interval Capacity: parameter.

Low Interval Capacity:

This is the weight capacity for the low interval. If the setting displayed is acceptable, press the ▼ Down Arrow to advance to the Middle Interval Value: parameter.

If the current setting is not acceptable, use the numeric keys to enter the capacity for the low interval and press the ▼ Down Arrow to advance to the Middle Interval Value: parameter.

Note that the value entered for Low Interval Capacity cannot exceed 7 digits and must be less than the overall capacity.

Middle Interval Value:

This is the middle interval value. If the setting displayed is acceptable, press the ▼ Down Arrow to advance to the Middle Interval Decimal: parameter.

If the current setting is not acceptable, use the numeric keys to enter the middle interval weight increment value and press the ▼ Down Arrow to advance to the Middle Interval Decimal: parameter.

Note that the value entered for the Middle Interval Value: cannot exceed 7 digits and must be greater than the low interval value.

SETUP, CONT.

Intervals:, Cont.

Middle Interval Decimal:

This is the number of decimal places for the middle interval value. If the setting displayed is acceptable, press the ▼ Down Arrow to advance to the Middle Interval Capacity: parameter.

If the current setting is not acceptable, use the numeric keys to enter the middle interval decimal places and press the ▼ Down Arrow to advance to the Middle Interval Capacity: parameter.

Allowable values are 0 to 4.

0 = ##### 1 = #####.# 2 = #####.## 3 = #####.### 4 = ###.####

Middle Interval Capacity:

This is the weight capacity for the middle interval. If the setting displayed is acceptable, press the ▼ Down Arrow to advance to the High Interval Value: parameter.

If the current setting is not acceptable, use the numeric keys to enter the weight capacity for the middle interval and press the ▼ Down Arrow to advance to the High Interval Value: parameter.

Note that the value entered cannot exceed 7 digits and must be less than the overall capacity and greater than the low capacity.

High Interval Value:

This is the high interval value. If the setting displayed is acceptable, press the ▼ Down Arrow to advance to the High Interval Decimal: parameter.

If the current setting is not acceptable, use the numeric keys to enter the high interval weight increment value and press the ▼ Down Arrow to advance to the High Interval Decimal: parameter.

Note that the value entered for the High Interval Value: cannot exceed 7 digits and must be greater than the middle interval value.

High Interval Decimal:

This is the number of decimal places for the high interval value. If the setting displayed is acceptable, press the **ENTER** key to save the setting.

The display will change to show Setting Parameters and then Setting Multi-Interval in the upper left corner and then change to the **Totalizer** screen.

If the current setting is not acceptable, use the numeric keys to enter the high interval decimal places and press the **ENTER** key to save the new setting.

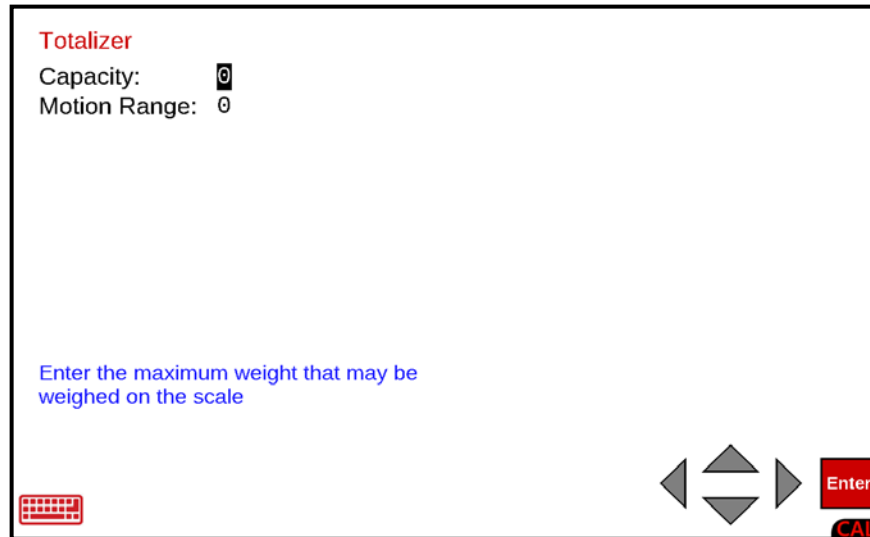
Allowable values are 0 to 4.

0 = ##### 1 = #####.# 2 = #####.## 3 = #####.### 4 = ###.####

The display will change to show Setting Parameters and then Setting Multi-Interval in the upper left corner and then change to the **Totalizer** screen.

SETUP, CONT.

Totalizer



Capacity:

With the **Totalizer** screen displayed the current setting for the Capacity: parameter will be shown. If the setting displayed is acceptable, press the ▼ Down Arrow to advance to the next parameter.

If the current setting is not acceptable, use the numeric keys to enter the Totalizer capacity and press the ▼ Down Arrow to advance to the next parameter, or press the **ENTER** key to save the new setting and return to the **Setup Scale Number** screen. Note that the Capacity cannot exceed 7 digits.

Allowable values are **1** through **9,999,999**.

Motion Range:

With the **Totalizer** screen displayed the current setting for the Motion Range: parameter will be shown. If the setting displayed is acceptable, press the **ENTER** key to save the new setting and return to the **Setup Scale Number** screen.

If the current setting is not acceptable, use the numeric keys to enter the motion range (the number of divisions of change permitted before indicating unstable) and press the ▼ Down Arrow to advance to the next parameter or press the **ENTER** key to save the new setting and return to the **Setup Scale Number** screen.

Allowable values are **0** to **9**.

NOTE: Entering zero (**0**) will disable the motion range.

SETUP, CONT.

Select Scale to Calibrate

Setup Scale Number

Scale 1

Scale 2

Scale 3

Total

Enter

CAL

NOTE: In the following instructions, **X** is the scale number selected to calibrate.

With the **Setup Scale Number** screen displayed, press the scale number on the touchscreen for the scale to calibrate or use the numeric keys to enter the number for the scale to calibrate or use the Navigation Keys to select (highlight) the scale to calibrate and press the **ENTER** key. The display will change to show the **Scale X - Calibration Options** screen.

Calibrate Selected Scale

2. Calibrate

With the **Scale X - Calibration Options** screen displayed, press the 2. Calibrate menu option or use the Qwerty keyboard and press the **2** key to select 2. Calibrate, or use the Navigation Keys to select (highlight) 2. Calibrate and press the **ENTER** key. The display will change to show the **Scale X - Calibration Weight 1** screen.

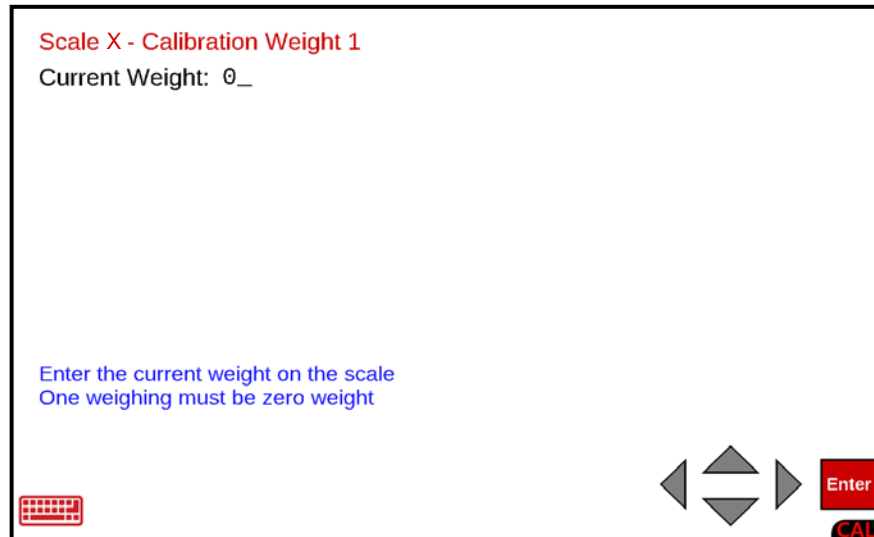
SETUP, CONT.

Calibrate Selected Scale, Cont.

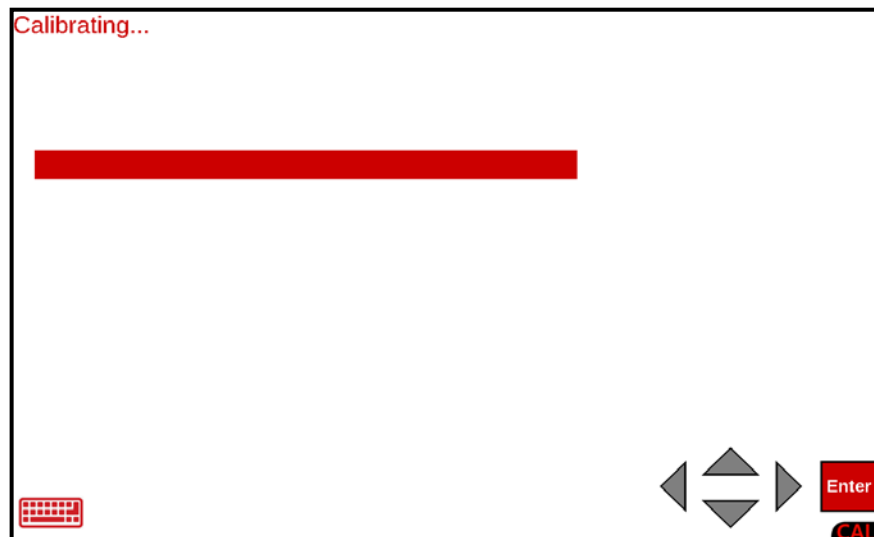
NOTE: The following instructions use two calibration points in addition to the zero (no load) weight. These two points could correspond to a mid-point weight and the test (load) weight. In the examples shown, Weight 1 is zero (no load), Weight 2 is the mid-point weight, and Weight 3 is the test (load) weight.

Calibration Weight 1

1. If this is the zero weight (no load), ensure there is zero weight (no load) on the scale and then using the numeric keys enter a **0** and press the **ENTER** key.
2. Otherwise, place the weight on the scale and then using the numeric keys, enter the current weight on the scale and press the **ENTER** key.



3. The display will change to show **Calibrating...** and a bar graph proceeding from left to right will be shown. When this step has been completed, the display will change to show the **Scale X - Calibration Weight 2** screen.

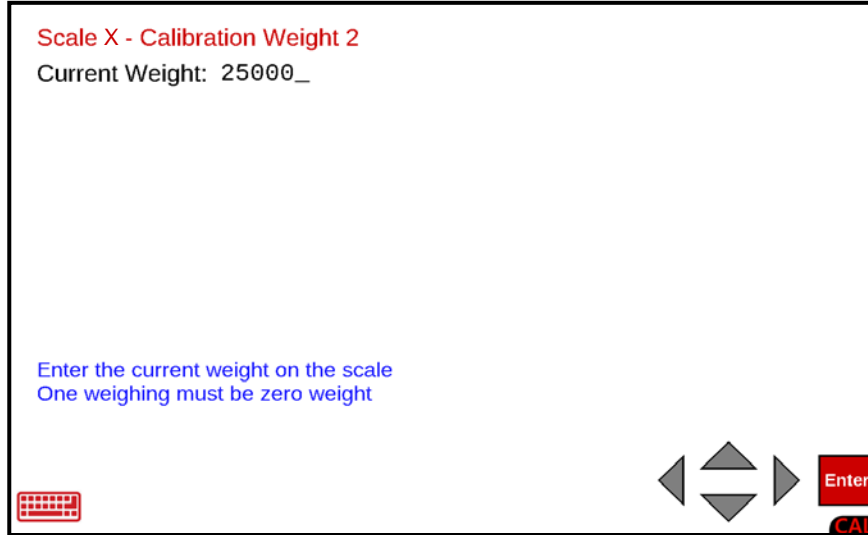


SETUP, CONT.

Calibrate Selected Scale, Cont.

Calibration Weight 2

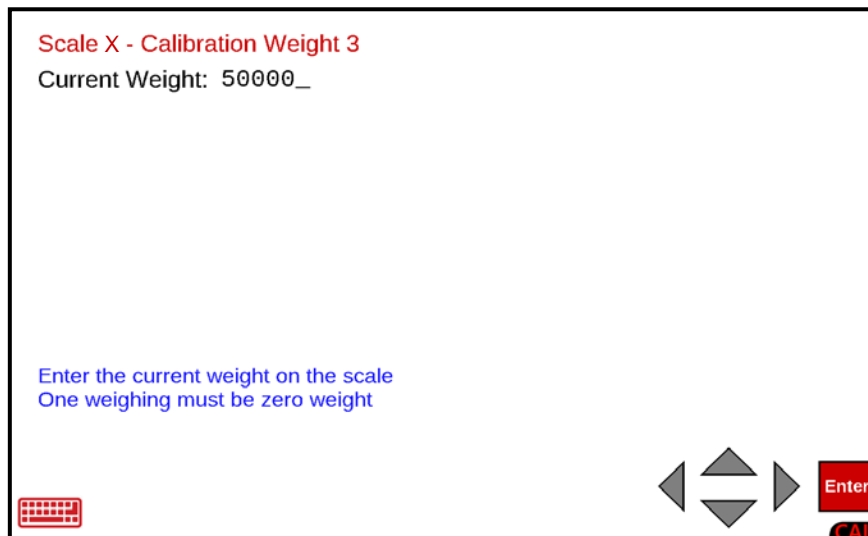
1. Place the mid-point weight on the scale and then using the numeric keys, enter the current weight on the scale and press the **ENTER** key
2. Otherwise, if this is the zero weight (no load), ensure there is zero weight (no load) on the scale and then using the numeric keys enter a **0** and press the **ENTER** key.



3. The display will change to show Calibrating... and a bar graph proceeding from left to right will be shown. When this step has been completed, the display will change to show the **Scale 1 - Calibration Weight 3** screen.

Calibration Weight 3

1. Place the test (load) weight on the scale and then using the numeric keys, enter the current weight on the scale and press the **ENTER** key
2. Otherwise, if this is the zero weight (no load), ensure there is zero weight (no load) on the scale and then using the numeric keys enter a **0** and press the **ENTER** key.



SETUP, CONT.

Calibrate Selected Scale, Cont.

Calibration Weight 3, Cont.

3. The display will change to show Calibrating... and a bar graph proceeding from left to right will be shown. When this step has been completed, the display will change to show the **Scale 1 - Fine Span** screen.

NOTE: If Fine Span adjustment is desired, proceed to the Fine Span Adjustment section following the **Calibration from the Setup Menu** section.



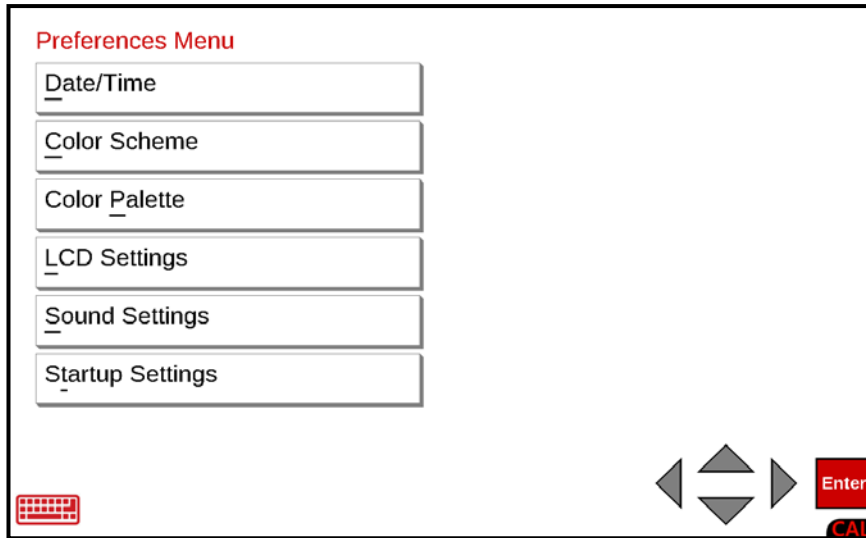
IMPORTANT! Repeat the above steps for each scale in the Totalizer group.

SETUP, CONT.

Preferences

Preferences Menu

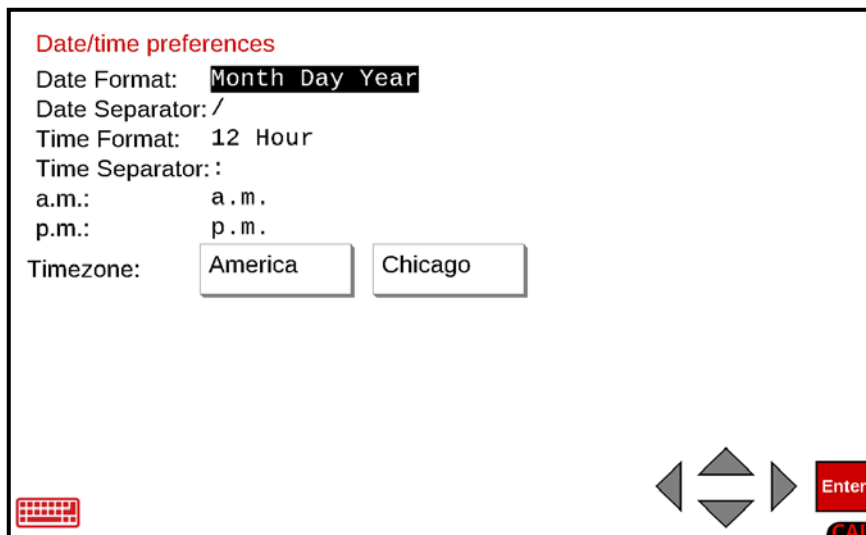
With the **Setup Menu** screen displayed, press the Preferences menu option, or use the qwerty keyboard and press the **P** key to select Preferences, or use the Navigation Keys to select (highlight) Preferences and press the **ENTER** key. The display will change to show the **Preferences Menu** screen.



Date/Time

The **Preferences Menu**, **Date/Time** menu option allows you to review and if desired, customize the factory default settings for the date and time format and to select the time zone used by the indicator.

With the **Preferences Menu** screen displayed, press the Date/Time menu option, or use the qwerty keyboard and press the **D** key to select Date/Time, or use the Navigation Keys to select (highlight) Date/Time and press the **ENTER** key. The display will change to show the **Date/time preferences** screen.



SETUP, CONT.

Date Format:

With the **Date/time preferences** screen displayed the current setting for the Date Format: parameter will be shown. If the setting displayed is acceptable, press the ▼ Down Arrow to advance to the next parameter.

If the current setting is not acceptable, press the **SPACE** key to step through and select the date format, and press the ▼ Down Arrow to advance to the next parameter or press the **ENTER** key to return to the **Preferences Menu** screen.

The available Date Formats are:

Day Month Year

Year Month Day

Month Day Year

Date Separator:

With the **Date/time preferences** screen displayed the current setting for the Date Separator: parameter will be shown. If the setting displayed is acceptable, press the ▼ Down Arrow to advance to the next parameter.

If the current setting is not acceptable, use the numeric keys or the Qwerty keyboard to enter a character, e.g., / or - (forward slash or dash) for the date separator and press the ▼ Down Arrow to advance to the next parameter or press the **ENTER** key to save the new setting and return to the **Preferences Menu** screen.

Time Format:

With the **Date/time preferences** screen displayed the current setting for the Time Format: parameter will be shown. If the setting displayed is acceptable, press the ▼ Down Arrow to advance to the next parameter.

If the current setting is not acceptable, press the **SPACE** key to toggle between 12-hour or 24-hour time format and press the ▼ Down Arrow to advance to the next parameter, or press the **ENTER** key to save the new setting and return to the **Preferences Menu** screen.

The available Time Formats are **12-hour** or **24-hour**.

Time Separator:

With the **Date/time preferences** screen displayed the current setting for the Time Separator: parameter will be shown. If the setting displayed is acceptable, press the ▼ Down Arrow to advance to the next parameter.

If the current setting is not acceptable, use the numeric keys or the Qwerty keyboard to enter a character, e.g. : (a colon) for the time separator and press the ▼ Down Arrow to advance to the next parameter or press the **ENTER** key to save the new setting and return to the **Preferences Menu** screen.

SETUP, CONT.

a.m.:

With the **Date/time preferences** screen displayed the current setting for the a.m.: parameter will be shown. If the setting displayed is acceptable, press the ▼ Down Arrow to advance to the next parameter.

If the current setting is not acceptable, use the Qwerty keyboard to enter new text for the a.m. time and press the ▼ Down Arrow to advance to the next parameter, or press the **ENTER** key to save the new setting and return to the **Preferences Menu** screen.

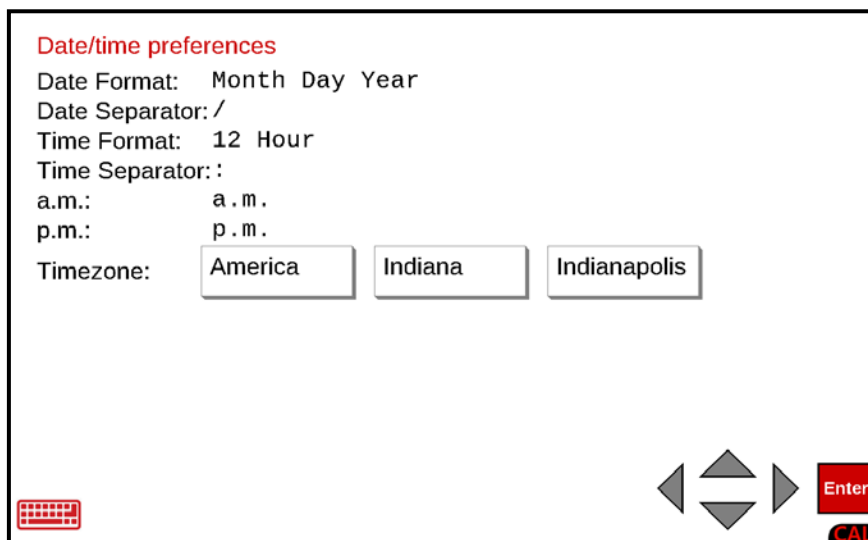
p.m.:

With the **Date/time preferences** screen displayed the current setting for the p.m.: parameter will be shown. If the setting displayed is acceptable, press the ▼ Down Arrow to advance to the next parameter.

If the current setting is not acceptable, use the Qwerty keyboard to enter new text for the p.m. time and press the ▼ Down Arrow to advance to the next parameter, or press the **ENTER** key to save the new setting and return to the **Preferences Menu** screen.

Timezone:

With the **Date/time preferences** screen displayed the current setting for the Timezone: parameter will be shown. If the setting displayed is acceptable, press the **ENTER** key to save the setting and return to the **Preferences Menu** screen.



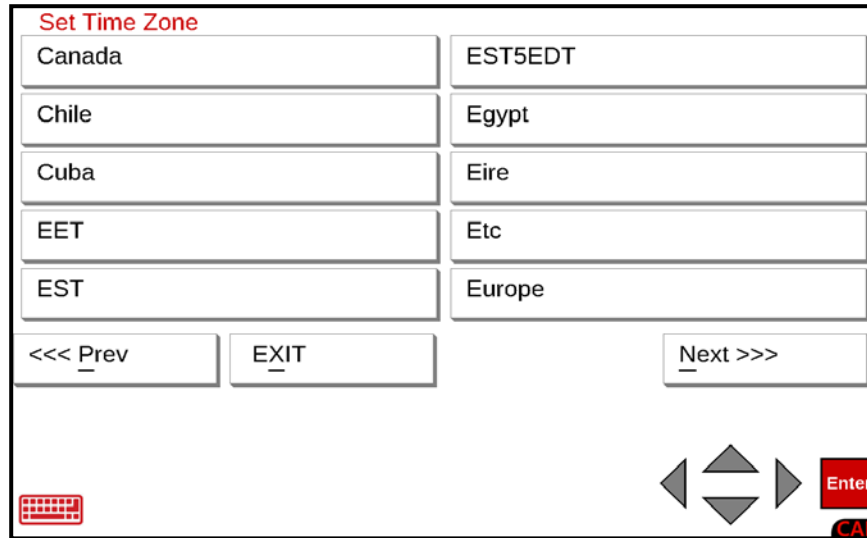
NOTE: The Timezone: parameter may show two or three selection parameters depending on the Continent and Region selected. Where applicable, a third selection parameter will be shown to indicate a Local time zone.

For example, in the example screen above, three selection parameters are shown. The first is the Continent time zone (America), the second is the Region time zone (Indiana and the third is the Local time zone (Indianapolis).

SETUP, CONT.

Time Zone:, Cont.

If the current setting is not acceptable, begin by pressing the left selection parameter to select the Timezone Continent. The display will change to show the **Set Time Zone** screen with the first list of available Continents.



Select Continent Time Zone

If the desired Continent is shown in the list on the first screen, press the Continent name on the touchscreen. The display will change to show to the **Date/time preferences** screen.

If the desired Continent is not shown, press Next on the touchscreen or use the Qwerty keyboard and press the **N** key to advance to the next list of Continents.

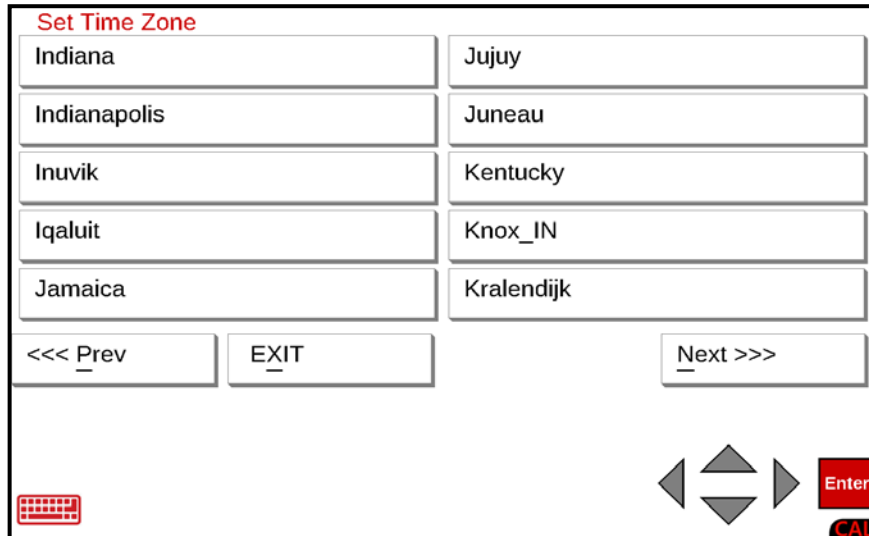
Repeat the above step until the desired Continent is shown on the screen and then press the Continent name on the touchscreen. The display will change to show to the **Date/time preferences** screen.

- Press <<< Prev on the touchscreen or use the Qwerty keyboard and press the **P** key to “back up” to the previous list of Continents.
- Press Next >>> on the touchscreen or use the Qwerty keyboard and press the **N** key to advance to the next list of Continents.
- Press EXIT on the touchscreen or use the Qwerty keyboard and press the **X** key to return to the **Preferences Menu** screen.

SETUP, CONT.

Time Zone:, Cont.

Next, press the middle selection parameter (or right selection parameter if only two) to select the Timezone Region. The display will change to show the **Set Time Zone** screen with the first list of available Regions.



Select Region Time Zone

If the desired Region is shown in the list on the first screen, press the Region name on the touchscreen. The display will change to show to the **Date/time preferences** screen.

If the desired Region is not shown, press Next on the touchscreen or use the Qwerty keyboard and press the **N** key to advance to the next list of Regions.

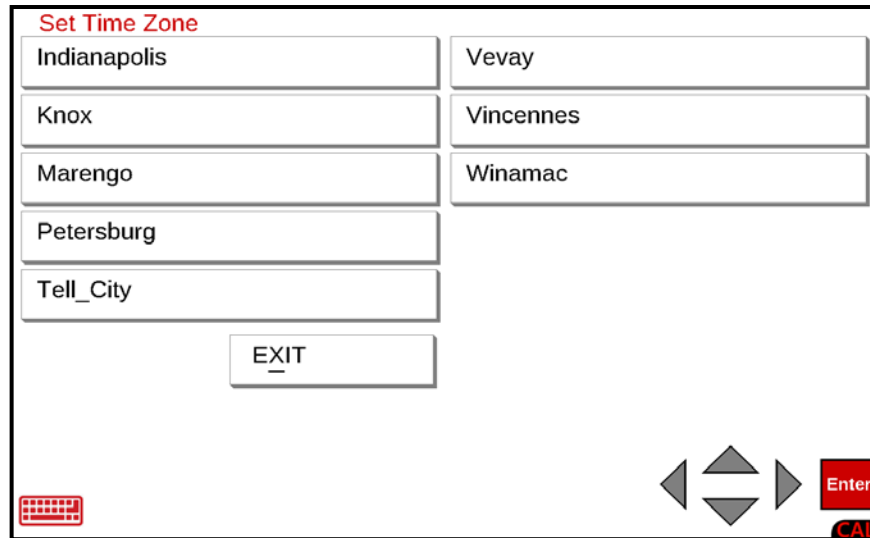
Repeat the above step until the desired Region is shown on the screen and then press the Region name on the touchscreen. The display will change to show the **Date/time preferences** screen.

- Press <<< Prev on the touchscreen or use the Qwerty keyboard and press the **P** key to “back up” to the previous list of Regions.
- Press Next >>> on the touchscreen or use the Qwerty keyboard and press the **N** key to advance to the next list of Regions.
- Press EXIT on the touchscreen or use the Qwerty keyboard and press the **X** key to return to the **Preferences Menu** screen.

SETUP, CONT.

Time Zone:, Cont.

Lastly, press the right selection parameter (if there are three) to select the Timezone Local time zone. The display will change to show the **Set Time Zone** screen with the first list of available Local time zones.



Select Local Time Zone

If the desired Local zone is shown in the list on the first screen, press the Local zone name on the touchscreen. The display will change to show to the **Date/time preferences** screen.

If the desired Local zone is not shown, press Next on the touchscreen or use the Qwerty keyboard and press the **N** key to advance to the next list of Local zones.

Repeat the above step until the desired Local zone is shown on the screen and then press the Local zone name on the touchscreen. The display will change to show the **Date/time preferences** screen.

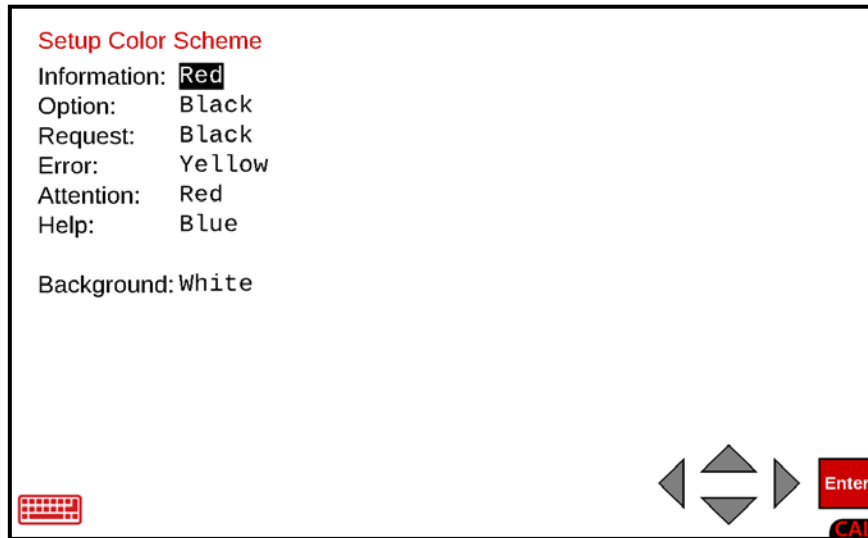
- Press <<< Prev on the touchscreen or use the Qwerty keyboard and press the **P** key to “back up” to the previous list of Local zones.
- Press Next >>> on the touchscreen or use the Qwerty keyboard and press the **N** key to advance to the next list of Local zones.
- Press EXIT on the touchscreen or use the Qwerty keyboard and press the **X** key to return to the **Preferences Menu** screen.

SETUP, CONT.

Color Scheme

The **Preferences Menu**, **Color Scheme** menu option allows you to review and if desired, customize the factory default colors for the various text displayed on the screen.

With the **Preferences Menu** screen displayed, press the **C**olor Scheme menu option, or use the qwerty keyboard and press the **C** key to select **C**olor Scheme, or use the Navigation Keys to select (highlight) **C**olor Scheme and press the **ENTER** key. The display will change to show the **Setup Color Scheme** screen.



Information:

With the **Setup Color Scheme** screen displayed the current setting for the Information: parameter will be shown. If the setting displayed is acceptable, press the ▼ Down Arrow to advance to the next parameter.

If the current setting is not acceptable, press the **SPACE** key to step through and select the color for information text displayed on the screen, and press the ▼ Down Arrow to advance to the next parameter or press the **ENTER** key to return to the **Preferences Menu** screen.

The available Colors for Information text are:

Red	Yellow	White	Gray
Cyan	C1*	C2*	C3*
C4*	C5*	C6*	C7*
C8*	Black	Blue	Green

***NOTE:** If C1 through C8 are selected, proceed to the **Preferences Menu**, **Color Palette** menu option to review the factory color settings and modify them for the color you desire. Note that the values shown for each color (standard and custom) are hexadecimal color codes.

SETUP, CONT.

Option:

With the **Setup Color Scheme** screen displayed the current setting for the Option: parameter will be shown. If the setting displayed is acceptable, press the ▼ Down Arrow to advance to the next parameter.

If the current setting is not acceptable, press the **SPACE** key to step through and select the color for the Option text displayed on the screen and press the ▼ Down Arrow to advance to the next parameter or press the **ENTER** key to return to the **Preferences Menu** screen.

The available Colors for Option text are:

Red	Yellow	White	Gray
Cyan	C1*	C2*	C3*
C4*	C5*	C6*	C7*
C8*	Black	Blue	Green

Request:

With the **Setup Color Scheme** screen displayed the current setting for the Request: parameter will be shown. If the setting displayed is acceptable, press the ▼ Down Arrow to advance to the next parameter.

If the current setting is not acceptable, press the **SPACE** key to step through and select the color for the Request text displayed on the screen, and press the ▼ Down Arrow to advance to the next parameter or press the **ENTER** key to return to the **Preferences Menu** screen.

The available Colors for Request text are:

Red	Yellow	White	Gray
Cyan	C1*	C2*	C3*
C4*	C5*	C6*	C7*
C8*	Black	Blue	Green

* **NOTE:** If C1 through C8 are selected, proceed to the **Preferences Menu, Color Palette** menu option to review the factory color settings and modify them for the color you desire. Note that the values shown for each color (standard and custom) are hexadecimal color codes.

SETUP, CONT.

Error:

With the **Setup Color Scheme** screen displayed the current setting for the Error: parameter will be shown. If the setting displayed is acceptable, press the ▼ Down Arrow to advance to the next parameter.

If the current setting is not acceptable, press the **SPACE** key to step through and select the color for Error text displayed on the screen and press the ▼ Down Arrow to advance to the next parameter or press the **ENTER** key to return to the **Preferences Menu** screen.

The available Colors for Error text are:

Red	Yellow	White	Gray
Cyan	C1*	C2*	C3*
C4*	C5*	C6*	C7*
C8*	Black	Blue	Green

Attention:

With the **Setup Color Scheme** screen displayed the current setting for the Attention: parameter will be shown. If the setting displayed is acceptable, press the ▼ Down Arrow to advance to the next parameter.

If the current setting is not acceptable, press the **SPACE** key to step through and select the color for Attention text displayed on the screen, and press the ▼ Down Arrow to advance to the next parameter or press the **ENTER** key to return to the **Preferences Menu** screen.

The available Colors for Attention text are:

Red	Yellow	White	Gray
Cyan	C1*	C2*	C3*
C4*	C5*	C6*	C7*
C8*	Black	Blue	Green

* **NOTE:** If C1 through C8 are selected, proceed to the **Preferences Menu, Color Palette** menu option to review the factory color settings and modify them for the color you desire. Note that the values shown for each color (standard and custom) are hexadecimal color codes.

SETUP, CONT.

Help:

With the **Setup Color Scheme** screen displayed the current setting for the Help: parameter will be shown. If the setting displayed is acceptable, press the ▼ Down Arrow to advance to the next parameter.

If the current setting is not acceptable, press the **SPACE** key to step through and select the color for Help text displayed on the screen and press the ▼ Down Arrow to advance to the next parameter or press the **ENTER** key to return to the **Preferences Menu** screen.

The available Colors for Help text are:

Red	Yellow	White	Gray
Cyan	C1*	C2*	C3*
C4*	C5*	C6*	C7*
C8*	Black	Blue	Green

Background:

With the **Setup Color Scheme** screen displayed the current setting for the Background: parameter will be shown. If the setting displayed is acceptable, press the ▼ Down Arrow to advance to the next parameter.

If the current setting is not acceptable, press the **SPACE** key to step through and select the screen Background color, and press the ▼ Down Arrow to advance to the next parameter or press the **ENTER** key to return to the **Preferences Menu** screen.

The available Colors for Background are:

Red	Yellow	White	Gray
Cyan	C1*	C2*	C3*
C4*	C5*	C6*	C7*
C8*	Black	Blue	Green

* **NOTE:** If C1 through C8 are selected, proceed to the **Preferences Menu, Color Palette** menu option to review the factory color settings and modify them for the color you desire. Note that the values shown for each color (standard and custom) are hexadecimal color codes.

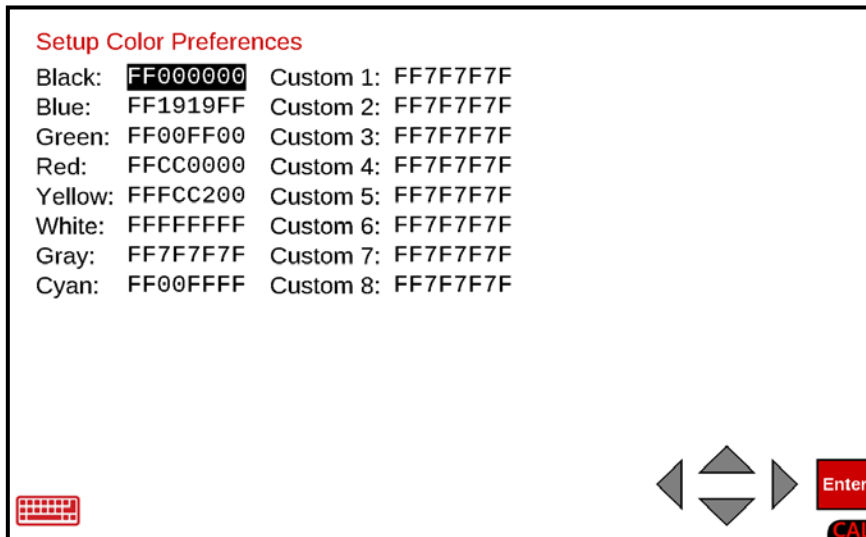
SETUP, CONT.

Color Palette

The **Preferences Menu**, **Color Palette** menu option allow you to review and if desired, customize the factory default values for the standard or custom colors displayed on the screen.

NOTE: The values shown for each color (standard and custom) are hexadecimal color codes.

With the **Preferences Menu** screen displayed, press the Color Palette menu option, or use the qwerty keyboard and press the **P** key to select Color Palette, or use the Navigation Keys to select (highlight) Color Palette and press the **ENTER** key. The display will change to show the **Setup Color Preferences** screen.



With the **Setup Color Preferences** screen displayed the current values for the Standard and Custom colors will be shown. If the values displayed for each color are acceptable, press the **ENTER** key to return to the **Preferences Menu** screen.

If the current values for the Standard and Custom colors are not acceptable, use the Navigation Keys ▲ Up Arrow or ▼ Down Arrow, and ◀ Left Arrow or ▶ Right Arrow to select the color to modify, and then use the Qwerty keyboard to enter the hexadecimal value for the desired color.

For example, to change Custom 4: to Magenta (hexadecimal color code #FF00FF), you would enter FFFF00FF.

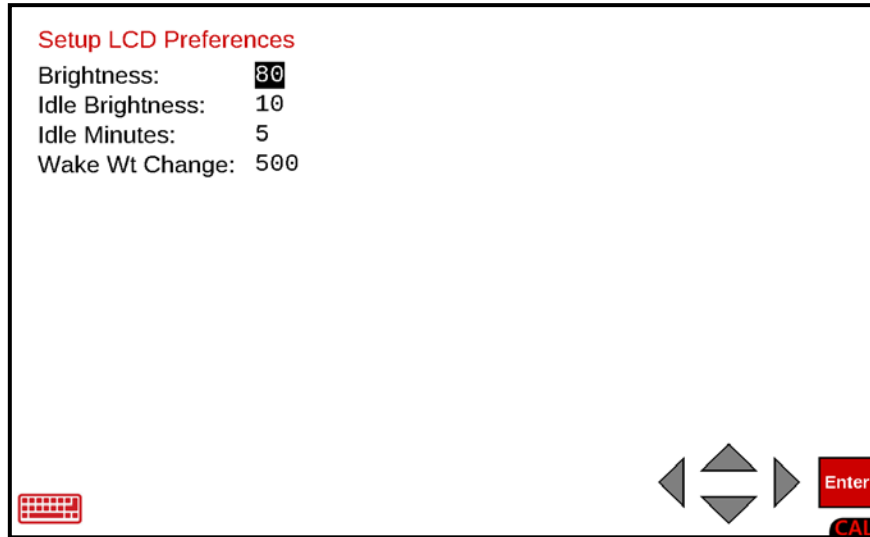
Repeat the above step until all the colors have been modified as desired and press the **ENTER** key to return to the **Preferences Menu** screen.

SETUP, CONT.

LCD Settings

The **Preferences Menu**, **LCD Settings** menu option allows you to review and if desired, customize the factory default values for the LCD Brightness, Idle time and brightness, and the amount of weight required to wake up the screen.

With the **Preferences Menu** screen displayed, press the LCD Settings menu option, or use the qwerty keyboard and press the **L** key to select LCD Settings, or use the Navigation Keys to select (highlight) LCD Settings and press the **ENTER** key. The display will change to show the **Setup LCD Preferences** screen.



Brightness:

With the **Setup LCD Preferences** screen displayed the current setting for the Brightness: parameter will be shown. If the setting displayed is acceptable, press the ▼ Down Arrow to advance to the next parameter.

If the current setting is not acceptable, use the numeric keys to enter the value for the Brightness and press the ▼ Down Arrow to advance to the next parameter or press the **ENTER** key to return to the **Preferences Menu** screen.

Allowable values for Brightness are 5 through 100.

Idle Brightness:

With the **Setup LCD Preferences** screen displayed the current setting for the Idle Brightness: parameter will be shown. If the setting displayed is acceptable, press the ▼ Down Arrow to advance to the next parameter.

If the current setting is not acceptable, use the numeric keys to enter the value for the Idle Brightness and press the ▼ Down Arrow to advance to the next parameter or press the **ENTER** key to return to the **Preferences Menu** screen.

Allowable values for Idle Brightness are 5 through 100.

SETUP, CONT.

Idle Minutes:

This is the amount of time with no activity on the scale before the indicator will dim the screen brightness to the Idle Brightness setting.

With the **Setup LCD Preferences** screen displayed the current setting for the Idle Minutes: parameter will be shown. If the setting displayed is acceptable, press the ▼ Down Arrow to advance to the next parameter.

If the current setting is not acceptable, use the numeric keys to enter the value for the Idle Minutes and press the ▼ Down Arrow to advance to the next parameter or press the **ENTER** key to return to the **Preferences Menu** screen.

Allowable values for Idle Brightness are 5 through 100.

Wake Wt Change:

This is the amount of weight required to wake up the screen after the period of no activity on the scale (idle minutes) activates the idle brightness setting.

With the **Setup LCD Preferences** screen displayed the current setting for the Idle Minutes: parameter will be shown. If the setting displayed is acceptable, press the ▼ Down Arrow to advance to the next parameter.

If the current setting is not acceptable, use the numeric keys to enter the value for the Idle Minutes and press the ▼ Down Arrow to advance to the next parameter or press the **ENTER** key to return to the **Preferences Menu** screen. Note that the Wake Wt Change setting cannot exceed 7 digits.

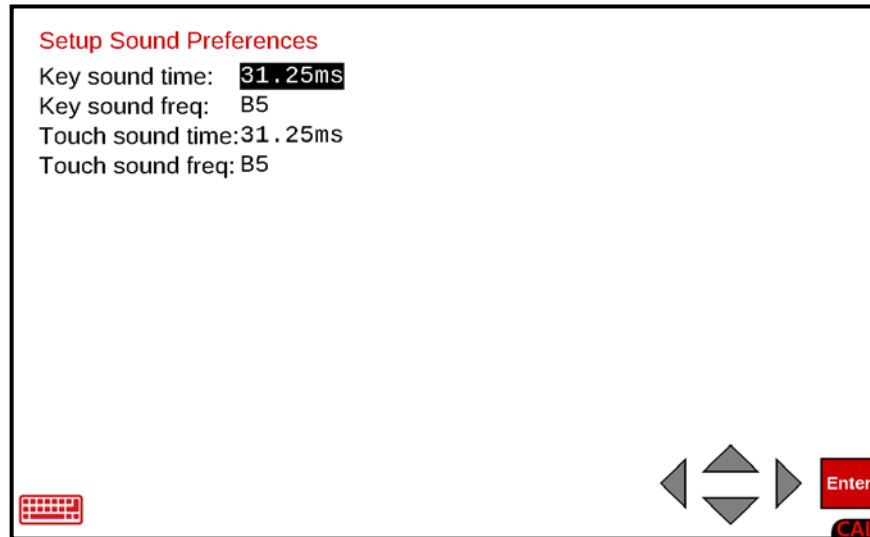
Allowable values for Wake Wt Change are 1 through 9,999,999.

SETUP, CONT.

Sound Settings

The **Preferences Menu**, **Sound Settings** menu option allows you to review and if desired, customize the beep that occurs each time a key is pressed or the screen is touched. The duration of the beep as well as the sound frequency (note and octave) produced can be set or the beep can be turned off.

With the **Preferences Menu** screen displayed, press the Sound Settings menu option, or use the qwerty keyboard and press the **S** key to select Sound Settings, or use the Navigation Keys to select (highlight) Sound Settings and press the **ENTER** key. The display will change to show the **Setup Sound Preferences** screen.



Key sound time:

This is the length of time the beep sounds each time a key is pressed. The key sound time (beep duration) can be from off (no beep) to a full one second.

With the **Setup Sound Preferences** screen displayed, the current setting for the Key sound time: parameter will be shown. If the setting displayed is acceptable, press the ▼ Down Arrow to advance to the next parameter.

If the current setting is not acceptable, press the **SPACE** key to step through and select the key sound time, and press the ▼ Down Arrow to advance to the next parameter or press the **ENTER** key to save the new setting and return to the **Preferences Menu** screen.

The available settings for the Key sound time are:

31.25ms	62.5ms	125ms	250ms
500ms	1sec	None (no beep)	

Note that **ms** = millisecond (1/1000 of a second).

SETUP, CONT.

Key sound freq:

The Key sound freq. is the frequency (note and octave) of the key beep sound.

With the **Setup Sound Preferences** screen displayed, the current setting for the Key sound freq: parameter will be shown. If the setting displayed is acceptable, press the ▼ Down Arrow to advance to the next parameter.

If the current setting is not acceptable, press the **SPACE** key to step through and select the key sound freq (note and octave), and press the ▼ Down Arrow to advance to the next parameter or press the **ENTER** key to save the new setting and return to the **Preferences Menu** screen.

The available selections for the Key sound freq are:

B5 C6 E6 G6 A6 C7 D7 E7 C5 D5 E5 F5 G5 A5

Touch sound time:

This is the length of time the beep sounds each time the screen is touched. The touch sound time (beep duration) can be from off (no beep) to a full one second.

With the **Setup Sound Preferences** screen displayed, the current setting for the Key sound time: parameter will be shown. If the setting displayed is acceptable, press the ▼ Down Arrow to advance to the next parameter.

If the current setting is not acceptable, press the **SPACE** key to step through and select the touch sound time, and press the ▼ Down Arrow to advance to the next parameter or press the **ENTER** key to save the new setting and return to the **Preferences Menu** screen.

The available settings for the Touch sound time are:

31.25ms	62.5ms	125ms	250ms
500ms	1sec	None (no beep)	

Note that **ms** = millisecond (1/1000 of a second).

SETUP, CONT.

Touch sound freq:

The Touch sound freq. is the frequency (note and octave) of the touchscreen beep sound.

With the **Setup Sound Preferences** screen displayed, the current setting for the Touch sound freq: parameter will be shown. If the setting displayed is acceptable, press the **ENTER** key to return to the **Preferences Menu** screen.

If the current setting is not acceptable, press the **SPACE** key to step through and select the touch sound freq (note and octave), and press the **ENTER** key to save the new setting and return to the **Preferences Menu** screen.

The available selections for the Key sound freq are:

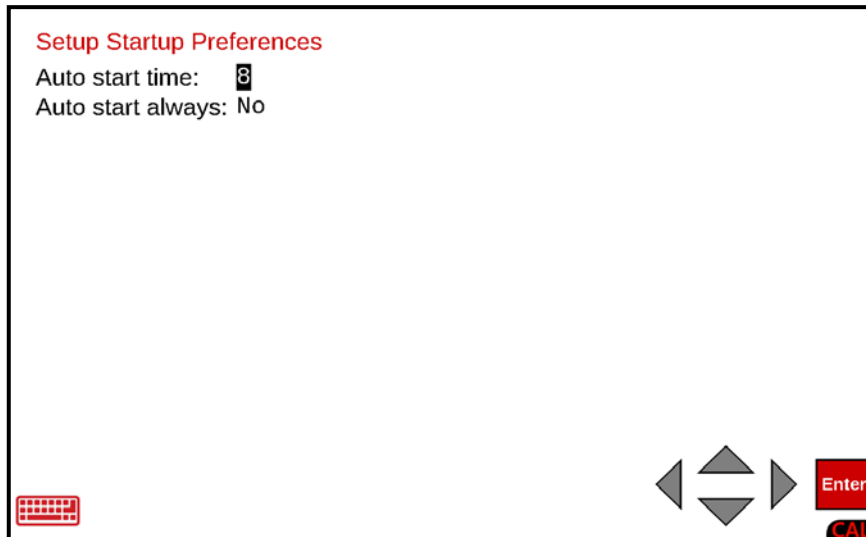
B5 C6 E6 G6 A6 C7 D7 E7 C5 D5 E5 F5 G5 A5

SETUP, CONT.

Startup Settings

The **Preferences Menu**, **Startup Settings** menu option allows you to review and if desired, customize the automatic startup time and select whether the **APPLICATION MENU** is automatically displayed or the screen remains on the Start-Up screen.

With the **Preferences Menu** screen displayed, press the Startup Settings menu option, or use the qwerty keyboard and press the **t** key to select Startup Settings, or use the Navigation Keys to select (highlight) Startup Settings and press the **ENTER** key. The display will change to show the **Setup Startup Preferences** screen.



Auto start time:

This is the length of time (in seconds) of the countdown timer that is shown on the **Start-Up** screen after turning on the indicator before the **APPLICATION MENU** is automatically displayed.

With the **Setup Startup Preferences** screen displayed the current setting for the Auto start time: parameter will be shown. If the setting displayed is acceptable, press the ▼ Down Arrow to advance to the next parameter.

If the current setting is not acceptable, use the numeric keys to enter the value for the Auto start time and press the ▼ Down Arrow to advance to the next parameter or press the **ENTER** key to return to the **Preferences Menu** screen.

Allowable values for Auto start time are 1 through 20.

SETUP, CONT.

Auto start always:

This selects whether the Auto start for showing the Application Menu is enabled or disabled.

With the **Setup Startup Preferences** screen displayed the current setting for the Auto start always: parameter will be shown. If the setting displayed is acceptable, press the **ENTER** key to return to the **Preferences Menu** screen.

If the current setting is not acceptable, press the **SPACE** key to toggle the setting between Yes and No.

- Select Yes to enable Auto start always (automatically load and show the Application Menu) and press the **ENTER** key to return to the **Preferences Menu** screen.
- Select NO to disable Auto start always (remain on the Start-up screen) and press the **ENTER** key to return to the **Preferences Menu** screen.

SETUP, CONT.

Date/Time

With the **Setup Menu** screen displayed, press the Date/Time menu option, or use the qwerty keyboard and press the **D** key to select Date/Time, or use the Navigation Keys to select (highlight) Date/Time and press the **ENTER** key. The display will change to show the **Set Date/Time** screen.



Automatic:

With the **Set Date/Time** screen displayed, the current setting for the Automatic: parameter will be shown. If the setting displayed is acceptable, press the **ENTER** key to return to the **Setup Menu** screen.

If the current setting is not acceptable, press the **SPACE** key to toggle the setting between Yes and No.

- Select Yes to enable automatic date/time updates from a network server and press the **ENTER** key to return to the **Setup Menu** screen.

NOTE: If Automatic: is *enabled* (set to Yes), setting the date and time on any other setup or operation screen will be ignored and the network date and time will be used.

- Select No to disable automatic date/time updates from a server (and manually enter the date and time) and press the ▼ Down Arrow to advance to the next parameter.

NOTE: If Automatic: is *disabled* (set to No), the following parameters will be shown and require data to be entered.

Year:

With the **Set Date/Time** screen displayed the current setting for the Year: parameter will be shown. If the setting displayed is acceptable, press the ▼ Down Arrow to advance to the next parameter.

If the current setting is not acceptable, use the numeric keys to enter the Year (e.g., 2023) and press the ▼ Down Arrow to advance to the next parameter, or press the **ENTER** key to save the new setting and return to the **Setup Menu** screen.

SETUP, CONT.

Month:

With the **Set Date/Time** screen displayed the current setting for the Month: parameter will be shown. If the setting displayed is acceptable, press the ▼ Down Arrow to advance to the next parameter.

If the current setting is not acceptable, use the numeric keys to enter the Month (1 = Jan, 2 = Feb...12 = Dec) and press the ▼ Down Arrow to advance to the next parameter or press the **ENTER** key to save the new setting and return to the **Setup Menu** screen.

Day:

With the **Set Date/Time** screen displayed the current setting for the Day: parameter will be shown. If the setting displayed is acceptable, press the ▼ Down Arrow to advance to the next parameter.

If the current setting is not acceptable, use the numeric keys to enter the Day of the month (1 to 31) and press the ▼ Down Arrow to advance to the next parameter, or press the **ENTER** key to save the new setting and return to the **Setup Menu** screen.

Hour:

With the **Set Date/Time** screen displayed the current setting for the Hour: parameter will be shown. If the setting displayed is acceptable, press the ▼ Down Arrow to advance to the next parameter.

If the current setting is not acceptable, use the numeric keys to enter the Hour in 24-hour time (e.g., 3 p.m. = 15) and press the ▼ Down Arrow to advance to the next parameter or press the **ENTER** key to save the new setting and return to the **Setup Menu** screen.

Minute:

With the **Set Date/Time** screen displayed the current setting for the Minute: parameter will be shown. If the setting displayed is acceptable, press the ▼ Down Arrow to advance to the next parameter.

If the current setting is not acceptable, use the numeric keys to enter the Minutes (0 to 59) and press the ▼ Down Arrow to advance to the next parameter, or press the **ENTER** key to save the new setting and return to the **Setup Menu** screen.

Second:

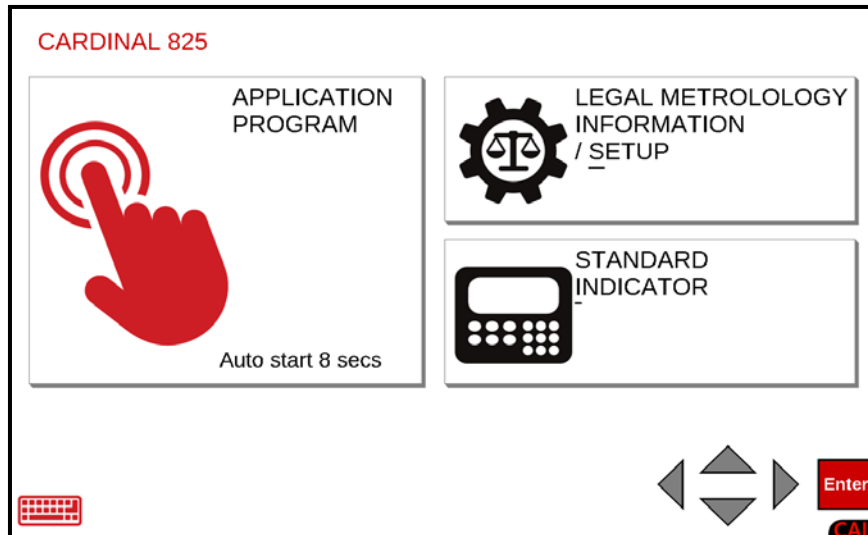
With the **Set Date/Time** screen displayed the current setting for the Second: parameter will be shown. If the setting displayed is acceptable, press the **ENTER** key or the Navigation Keys ◀ Left Arrow to return to the **Setup Menu** screen.

If the current setting is not acceptable, use the numeric keys to enter the Seconds (0 to 59) and press the **ENTER** key to save the new setting, and return to the **Setup Menu** screen.

OPERATORS

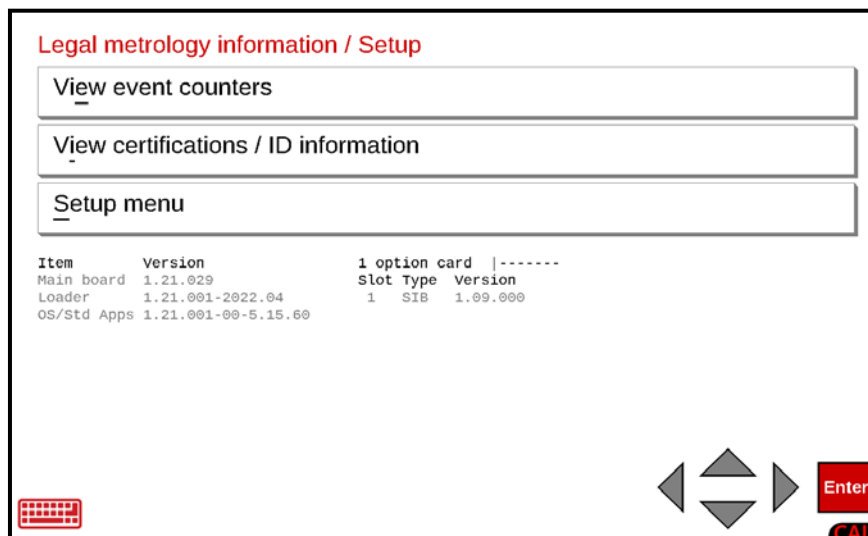
The Model 825 Desktop Weight Indicator supports up to eight operators. One operator, the Administrator has full access to all functions and features of the 825. The remaining seven can be configured to allow or prevent access to various functions and features. Note that only the Login name and Password can be changed for the Administrator operator.

1. Press the Push Button Power Switch on the rear enclosure of the 825 to turn it on. The display will perform a short self-test and then change to the **Start-Up** screen.



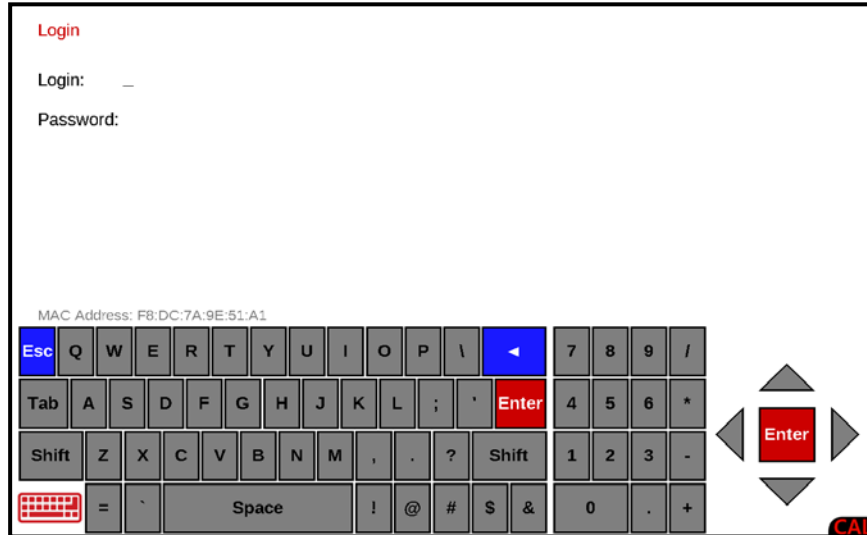
NOTE: When the 825 is initially started, an Auto-start countdown beginning at 8 seconds will appear on the APPLICATION PROGRAM selection. When the countdown is complete, the application program mode will automatically start.

2. With the **Start-Up** screen displayed, press the LEGAL METROLOGY INFORMATION / SETUP selection on the touchscreen or use the Qwerty keyboard and press the **S** key to select LEGAL METROLOGY INFORMATION / SETUP or use the Navigation Keys ► Right Arrow to (highlight) the selection and press the **ENTER** key.
3. The display will change to show the **Legal metrology information / Setup** screen.



OPERATORS, CONT.

With the **Legal metrology information / Setup** screen displayed, press the Navigation Keys ▼ Down Arrow to (highlight) the Setup menu option and press the **ENTER** key or use the Qwerty keyboard and press the **S** key to select the Setup menu option. The display will change to show the **Login** screen and prompt for the Login and Password.

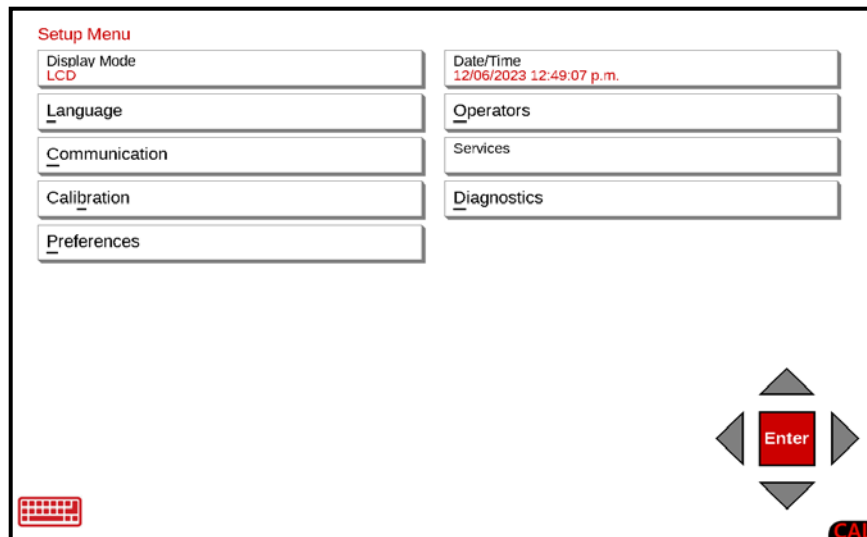


1. With the **Login** screen and prompt displayed, use the Qwerty keyboard to enter the Login and press the ▼ Down Arrow to advance to the Password prompt.
2. Enter the Password using the numeric keys and press the **ENTER** key to proceed with Setup.



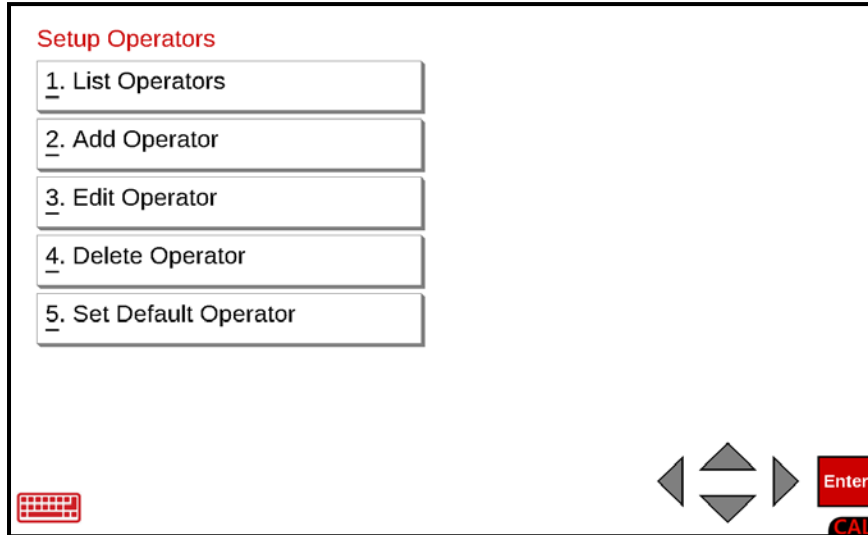
NOTE: The 825 will arrive from the factory with the calibration access locked by the “Login” and “Password” prompts protection. The factory default Login and Password are “ADMIN” and “81440”.

3. After logging in, the display will change to the **Setup Menu** screen.



OPERATORS, CONT.

With the **Setup Menu** screen displayed, press the Operators menu option, or use the Qwerty keyboard and press the **O** key to select Operators, or use the Navigation Keys to select (highlight) Operators and press the **ENTER** key. The display will change to show the **Setup Operators** screen.



1. List Operators

With the **Setup Operators** screen displayed, press the 1. List Operators menu option or use the Qwerty keyboard and press the **1** key to select 1. List Operators or use the Navigation Keys to select (highlight) 1. List Operators and press the **ENTER** key. The display will change to show the **Operator list** screen for the current programmed operators.



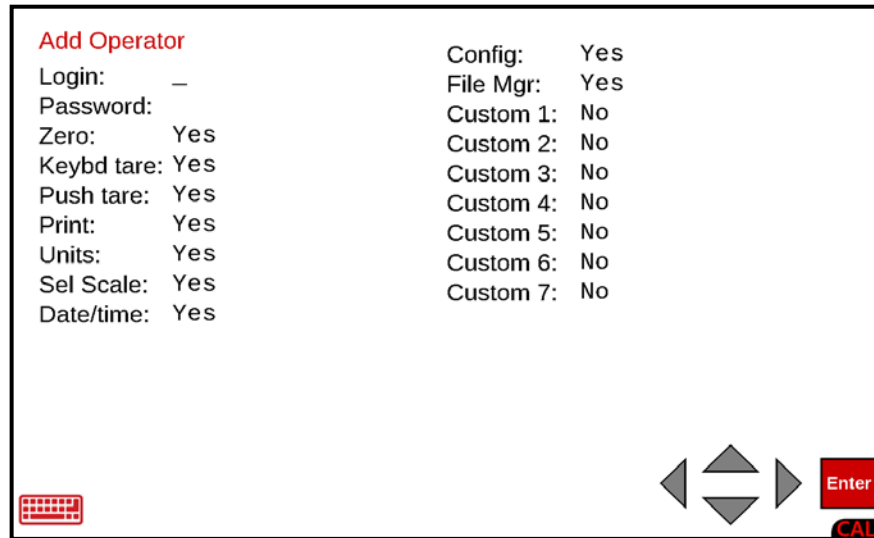
After viewing the list, press **Done** or **Enter** on the touchscreen, or use the Navigation Keys ◀ Left Arrow or use the Qwerty keyboard **Esc** key to exit viewing and return to the **Setup Operators** screen.

OPERATORS, CONT.

2. Add Operator

When you add an operator to the indicator, you are allowing that individual to have access to the functions and features of the indicator.

With the **Setup Operators** screen displayed, press the 2. Add Operator menu option or use the Qwerty keyboard and press the **2** key to select 2. Add Operator or use the Navigation Keys to select (highlight) 2. Add Operator and press the **ENTER** key. The display will change to show the **Add Operator** screen.



The screenshot shows the 'Add Operator' screen with the following configuration options:

Config:	Yes
File Mgr:	Yes
Custom 1:	No
Custom 2:	No
Custom 3:	No
Custom 4:	No
Custom 5:	No
Custom 6:	No
Custom 7:	No

Other options shown on the left side of the screen:

Login:	—
Password:	
Zero:	Yes
Keybd tare:	Yes
Push tare:	Yes
Print:	Yes
Units:	Yes
Sel Scale:	Yes
Date/time:	Yes

Navigation icons (left, up, down, right arrows) and an 'Enter' button are visible at the bottom right. A keyboard icon is at the bottom left, and 'CAL' is at the bottom right.

Login:

With the **Add Operator** screen displayed, use the Qwerty keyboard to enter a Login (name) for the operator (up to 8 characters, e.g., CARDINAL) and press the ▼ Down Arrow to advance to the next parameter.

Password:

With the **Add Operator** screen displayed, use the Qwerty keyboard to enter a Password for the operator (up to 8 characters) and press the ▼ Down Arrow to advance to the next parameter. If a Password is not required (or desired), it can be left blank. Note that the Password will be visible while entering it. During operations, a row of asterisks will be shown when entering the Password.

OPERATORS, CONT.

2. Add Operator, Cont.

NOTE: To change the displayed setting on the following parameters, use the Qwerty keyboard and press the **SPACE** key to toggle between **Yes** and **No** or press the **Y** key for **Yes** or the **N** key for **No**.

Zero:

This setting determines whether the operator is allowed to zero the scale.

With the **Add Operator** screen displayed, the current setting for Zero: will be shown. If the setting displayed is acceptable, press the ▼ Down Arrow to advance to the next parameter.

If the current setting is not acceptable, press the **SPACE** key to toggle between **Yes** and **No** (or press the **Y** or **N** key) and press the ▼ Down Arrow to advance to the next parameter.

Keybd tare:

This setting determines whether the operator is allowed to manually enter a tare weight.

With the **Add Operator** screen displayed, the current setting for Keybd tare: will be shown. If the setting displayed is acceptable, press the ▼ Down Arrow to advance to the next parameter.

If the current setting is not acceptable, press the **SPACE** key to toggle between **Yes** and **No** (or press the **Y** or **N** key) and press the ▼ Down Arrow to advance to the next parameter.

Push tare:

This setting determines whether the operator is allowed to use the Push Button tare function to enter a tare weight.

With the **Add Operator** screen displayed, the current setting for Push tare: will be shown. If the setting displayed is acceptable, press the ▼ Down Arrow to advance to the next parameter.

If the current setting is not acceptable, press the **SPACE** key to toggle between **Yes** and **No** (or press the **Y** or **N** key) and press the ▼ Down Arrow to advance to the next parameter.

Print:

This setting determines whether the operator is allowed to print a ticket.

With the **Add Operator** screen displayed, the current setting for Print: will be shown. If the setting displayed is acceptable, press the ▼ Down Arrow to advance to the next parameter.

If the current setting is not acceptable, press the **SPACE** key to toggle between **Yes** and **No** (or press the **Y** or **N** key) and press the ▼ Down Arrow to advance to the next parameter.

OPERATORS, CONT.

2. Add Operator, Cont.

Units:

This setting determines whether the operator is allowed to select the alternate weighing units.

With the **Add Operator** screen displayed, the current setting for Units: will be shown. If the setting displayed is acceptable, press the ▼ Down Arrow to advance to the next parameter.

If the current setting is not acceptable, press the **SPACE** key to toggle between **Yes** and **No** (or press the **Y** or **N** key) and press the ▼ Down Arrow to advance to the next parameter.

Sel Scale:

In a multiple-scale operation, this setting determines whether the operator is allowed to choose between available scales.

With the **Add Operator** screen displayed, the current setting for Sel Scale: will be shown. If the setting displayed is acceptable, press the ▼ Down Arrow to advance to the next parameter.

If the current setting is not acceptable, press the **SPACE** key to toggle between **Yes** and **No** (or press the **Y** or **N** key) and press the ▼ Down Arrow to advance to the next parameter.

Date/time:

This setting determines whether the operator is allowed to change the date and time.

With the **Add Operator** screen displayed, the current setting for Date/time: will be shown. If the setting displayed is acceptable, press the **ENTER** key to save the settings and return to the **Setup Operators** screen.

If the current setting is not acceptable, press the **SPACE** key to toggle between **Yes** and **No** (or press the **Y** or **N** key) and press the **ENTER** key to save the settings and return to the **Setup Operators** screen.

OPERATORS, CONT.

2. Add Operator, Cont.



IMPORTANT! If the displayed settings for the **Config:**, **File Mgr:**, and **Custom 1: to Custom 7:** parameters require changing, press the setting on the touchscreen of the desired parameter to select it.

Config:

This setting determines whether the operator is allowed to change the configuration.

With the **Add Operator** screen displayed, the current setting for **Config:** will be shown. If the setting displayed is acceptable, press the setting on the touchscreen of the next parameter to change or press the **ENTER** key to save the settings and return to the **Setup Operators** screen.

If the current setting is not acceptable, press the **SPACE** key to toggle between **Yes** and **No** (or press the **Y** or **N** key) and press the setting on the touchscreen of the next parameter to change or press the **ENTER** key to save the settings and return to the **Setup Operators** screen.

File Mgr:

This setting determines whether the operator is allowed to access the File Manager function.

With the **Add Operator** screen displayed, the current setting for **File Mgr:** will be shown. If the setting displayed is acceptable, press the setting on the touchscreen of the next parameter to change or press the **ENTER** key to save the settings and return to the **Setup Operators** screen.

If the current setting is not acceptable, press the **SPACE** key to toggle between **Yes** and **No** (or press the **Y** or **N** key) and press the setting on the touchscreen of the next parameter to change or press the **ENTER** key to save the settings and return to the **Setup Operators** screen.

Custom X: (where X: = Custom 1: to Custom 7:)

The setting for **Custom X:** determines whether the operator is allowed to access specified functions and features of Custom Applications installed on the indicator.

With the **Add Operator** screen displayed, the current setting for **Custom X:** will be shown. If the setting displayed is acceptable, press the setting on the touchscreen of the next parameter to change or press the **ENTER** key to save the settings and return to the **Setup Operators** screen.

If the current setting is not acceptable, press the **SPACE** key to toggle between **Yes** and **No** (or press the **Y** or **N** key) and press the setting on the touchscreen of the next parameter to change or press the **ENTER** key to save the settings and return to the **Setup Operators** screen.

OPERATORS, CONT.

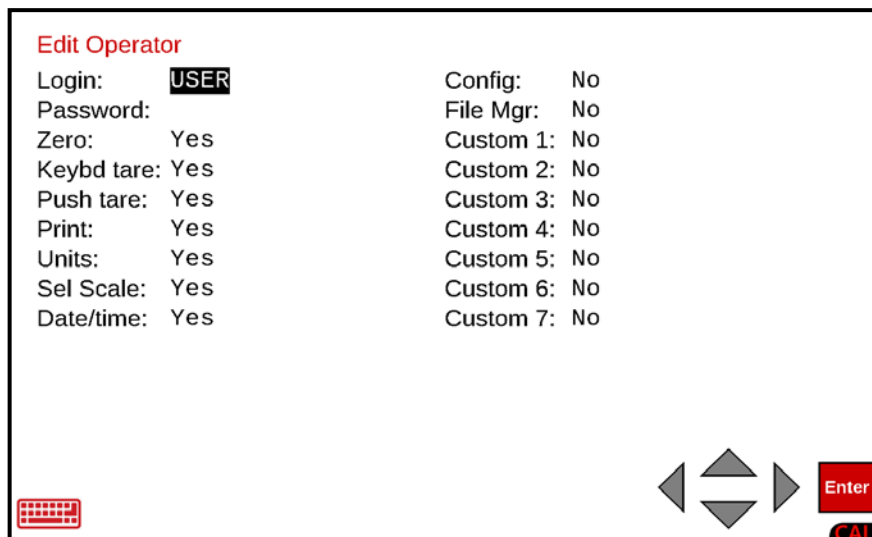
3. Edit Operator

The **Edit Operator** screen allows you to change the operator's previously configured access to functions and features of the indicator.

With the **Setup Operators** screen displayed, press the 3. Edit Operator menu option or use the Qwerty keyboard and press the **3** key to select 3. Edit Operator or use the Navigation Keys to select (highlight) 3. Edit Operator and press the **ENTER** key. The display will change to show the **Add Operator Login** screen and prompt for the operator Login (name).



Use the Qwerty keyboard to enter the operator Login and press the **ENTER** key. The display will change to the Edit Operator screen and show the current settings.



OPERATORS, CONT.

3. Edit Operator, Cont.

Login:

With the **Edit Operator** screen displayed, the current Login (name) will be shown. If the Login displayed is acceptable, press the ▼ Down Arrow to advance to the next parameter.

If the current setting is not acceptable, use the Qwerty keyboard to enter a new Login for the operator (up to 8 characters) and press the ▼ Down Arrow to advance to the next parameter.



IMPORTANT! Changing the Login REPLACES the current Login. It DOES NOT create a new Login in addition to an existing Login. It will, however, retain the settings from the old Login for the new Login (e.g., Zero: Yes, Keybd tare: No, etc.).

Password:

With the **Edit Operator** screen displayed, the current Password will be shown. If the Password displayed is acceptable, press the ▼ Down Arrow to advance to the next parameter.

If the current setting is not acceptable, use the Qwerty keyboard to enter a new Password for the operator (up to 8 characters) and press the ▼ Down Arrow to advance to the next parameter. If a Password is not required (or desired), it can be left blank. Note that the Password will be visible while entering it. During operations, a row of asterisks will be shown when entering the Password.

NOTE: To change the displayed setting on the following parameters, use the Qwerty keyboard and press the **SPACE** key to toggle between **Yes** and **No** or press the **Y** key for **Yes** or the **N** key for **No**.

Zero:

With the **Edit Operator** screen displayed, the current setting for Zero: will be shown. If the setting displayed is acceptable, press the ▼ Down Arrow to advance to the next parameter.

If the current setting is not acceptable, press the **SPACE** key to toggle between **Yes** and **No** (or press the **Y** or **N** key) and press the ▼ Down Arrow to advance to the next parameter.

Keybd tare:

With the **Edit Operator** screen displayed, the current setting for Keybd tare: will be shown. If the setting displayed is acceptable, press the ▼ Down Arrow to advance to the next parameter.

If the current setting is not acceptable, press the **SPACE** key to toggle between **Yes** and **No** (or press the **Y** or **N** key) and press the ▼ Down Arrow to advance to the next parameter.

OPERATORS, CONT.

3. Edit Operator, Cont.

Push tare:

With the **Edit Operator** screen displayed, the current setting for Push tare: will be shown. If the setting displayed is acceptable, press the ▼ Down Arrow to advance to the next parameter.

If the current setting is not acceptable, press the **SPACE** key to toggle between **Yes** and **No** (or press the **Y** or **N** key) and press the ▼ Down Arrow to advance to the next parameter.

Print:

With the **Edit Operator** screen displayed, the current setting for Print: will be shown. If the setting displayed is acceptable, press the ▼ Down Arrow to advance to the next parameter.

If the current setting is not acceptable, press the **SPACE** key to toggle between **Yes** and **No** (or press the **Y** or **N** key) and press the ▼ Down Arrow to advance to the next parameter.

Units:

With the **Edit Operator** screen displayed, the current setting for Units: will be shown. If the setting displayed is acceptable, press the ▼ Down Arrow to advance to the next parameter.

If the current setting is not acceptable, press the **SPACE** key to toggle between **Yes** and **No** (or press the **Y** or **N** key) and press the ▼ Down Arrow to advance to the next parameter.

Sel Scale:

With the **Edit Operator** screen displayed, the current setting for Sel Scale: will be shown. If the setting displayed is acceptable, press the ▼ Down Arrow to advance to the next parameter.

If the current setting is not acceptable, press the **SPACE** key to toggle between **Yes** and **No** (or press the **Y** or **N** key) and press the ▼ Down Arrow to advance to the next parameter.

Date/Time:

With the **Edit Operator** screen displayed, the current setting for Date/Time: will be shown. If the setting displayed is acceptable, press the ▼ Down Arrow to advance to the next parameter.

If the current setting is not acceptable, press the **SPACE** key to toggle between **Yes** and **No** (or press the **Y** or **N** key) and press the ▼ Down Arrow to advance to the next parameter.

OPERATORS, CONT.

3. Edit Operator, Cont.



IMPORTANT! If the displayed settings for the **Config:**, **File Mgr:**, and **Custom 1: to Custom 7:** parameters require changing, press the setting on the touchscreen of the desired parameter to select it.

Config:

With the **Edit Operator** screen displayed, the current setting for **Config:** will be shown. If the setting displayed is acceptable, press the setting on the touchscreen of the next parameter to change or press the **ENTER** key to save the settings and return to the **Setup Operators** screen.

If the current setting is not acceptable, press the **SPACE** key to toggle between **Yes** and **No** (or press the **Y** or **N** key) and press the setting on the touchscreen of the next parameter to change or press the **ENTER** key to save the settings and return to the **Setup Operators** screen.

File Mgr:

With the **Edit Operator** screen displayed, the current setting for **File Mgr:** will be shown. If the setting displayed is acceptable, press the setting on the touchscreen of the next parameter to change or press the **ENTER** key to save the settings and return to the **Setup Operators** screen.

If the current setting is not acceptable, press the **SPACE** key to toggle between **Yes** and **No** (or press the **Y** or **N** key) and press the setting on the touchscreen of the next parameter to change or press the **ENTER** key to save the settings and return to the **Setup Operators** screen.

Custom X: (where X: = Custom 1: to Custom 7:)

The setting for **Custom X:** determines whether the operator is allowed to access specified functions of Custom Applications installed on the indicator.

With the **Edit Operator** screen displayed, the current setting for **Custom X:** will be shown. If the setting displayed is acceptable, press the setting on the touchscreen of the next parameter to change or press the **ENTER** key to save the settings and return to the **Setup Operators** screen.

If the current setting is not acceptable, press the **SPACE** key to toggle between **Yes** and **No** (or press the **Y** or **N** key) and press the setting on the touchscreen of the next parameter to change or press the **ENTER** key to save the settings and return to the **Setup Operators** screen.

OPERATORS, CONT.

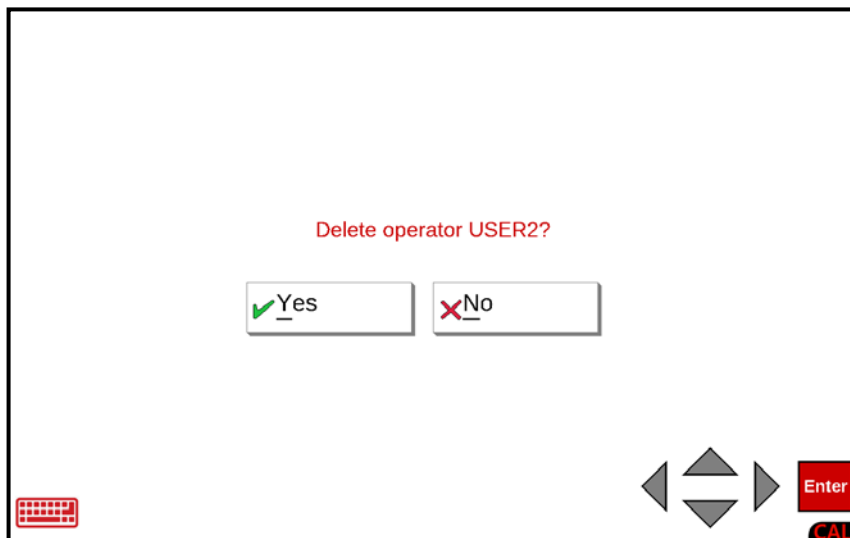
4. Delete Operator

The **Delete Operator** screen allows you to delete (remove) an operator Login and all previously configured settings for that Login.

With the **Setup Operators** screen displayed, press the **4**. Delete Operator menu option or use the Qwerty keyboard and press the **4** key to select **4**. Delete Operator or use the Navigation Keys to select (highlight) **4**. Delete Operator and press the **ENTER** key. The display will change to show the **Delete Operator** screen and prompt for the operator Login (name).



Use the Qwerty keyboard to enter the operator Login and press the **ENTER** key. The display will change to show the **Delete Operator** confirmation screen.



OPERATORS, CONT.

4. Delete Operator, Cont.

With the **Delete Operator?** confirmation screen displayed, press the Yes or No option on the screen, or use the Qwerty keyboard and press the **Y** or **N** key, or use the Navigation Keys to select (highlight) Yes or No and press the **ENTER** key.

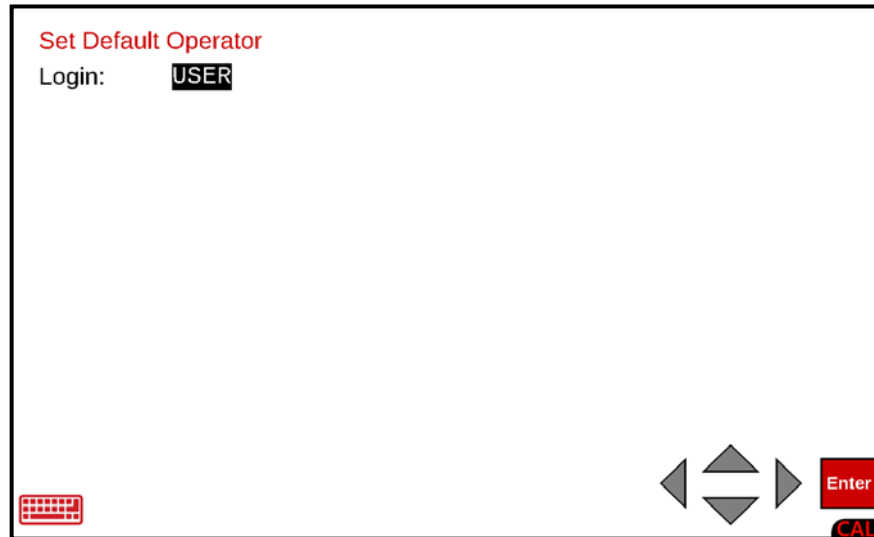
- If Yes is selected, all the settings for that operator Login will be deleted and the display will change to show the **Setup Operators** screen.
- If No is selected, all the settings for that operator Login will be retained (saved) and the display will change to show the **Setup Operators** screen.

OPERATORS, CONT.

5. Set Default Operator

The **Set Default Operator** screen allows you to select which operator Login the 825 will use when it is first turned on.

With the **Setup Operators** screen displayed, press the 5. Set Default Operator menu option or use the Qwerty keyboard and press the **5** key to select 5. Set Default Operator or use the Navigation Keys to select (highlight) 5. Set Default Operator and press the **ENTER** key. The display will change to show the **Set Default Operator** screen and the current default operator Login (name).



Default Login:

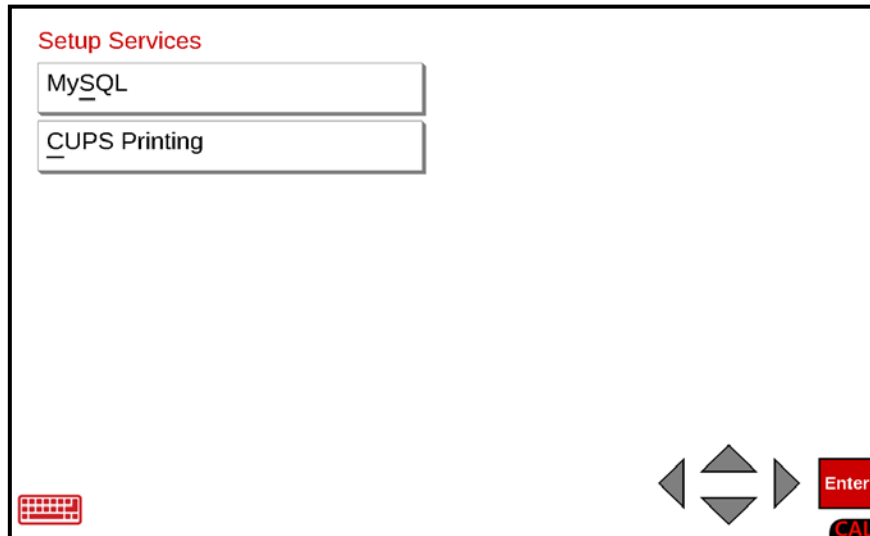
With the **Set Default Operator** screen displayed, the current Login (name) will be shown. If the Login displayed is acceptable, press the **ENTER** key to return to the **Setup Operators** screen.

If the current setting is not acceptable, use the Qwerty keyboard to enter a new Login for the Default Operator Login and press the **ENTER** key to return to the **Setup Operators** screen.

SERVICES

Setup Services

With the **Setup Menu** screen displayed, press the Services menu option, or use the Qwerty keyboard and press the **v** key to select Services, or use the Navigation Keys to select (highlight) Services and press the **ENTER** key. The display will change to show the **Setup Services** screen.



MySQL

With the **Setup Services** screen displayed, the current setting for the MySQL: parameter will be shown. If the setting displayed is acceptable, press the **ENTER** key to save the setting and return to the **Setup Menu** screen.

If the current setting is not acceptable, press the **SPACE** key to toggle the setting between Yes and No.

- Select **Yes** to use (enable) the MySQL(MariaDB) server and press the **ENTER** key to return to the **Setup Menu** screen.
- Select **No** to not use the MySQL(MariaDB) server (or if previously enabled, to disable it) and press the **ENTER** key to return to the **Setup Menu** screen.

NOTE: When Yes is selected for the MySQL: parameter, the label for the **Setup Menu, Services** menu option will change to show that the indicator is using MySQL (MariaDB).

SERVICES, CONT.

Setup CUPS Printing

CUPS, which stands for **Common Unix Printing System**, is an open-source printing system used on various Linux distributions. It provides a framework for managing and controlling printers in a Linux or Unix environment. Here are some key points about CUPS:

- **Functionality:** CUPS acts as a print spooler, scheduler, and print job manager. It can store information for numerous local or network printers.
- **Widespread Use:** It has become the standard print manager on most popular Linux distros.
- **Web Interface:** Most users interact with CUPS through its web interface, which runs on port 631. You can access it via any browser by navigating to localhost:631. In the web control panel, you can add or delete printers, install drivers, access the print spooler, and configure various settings.
- **Adding Printers:** To add a printer, go to the "Administration" section in the web interface and click "Add printer". If network printers aren't automatically discovered, you can manually add them via their network address.

With the **Setup Services** screen displayed, press the **C** key to select **CUPS Printing**, or use the Qwerty keyboard and press the **C** key to select **CUPS Printing**, or use the Navigation Keys to select (highlight) **CUPS Printing** and press the **ENTER** key. The display will change to show the **Setup CUPS Printing** screen.

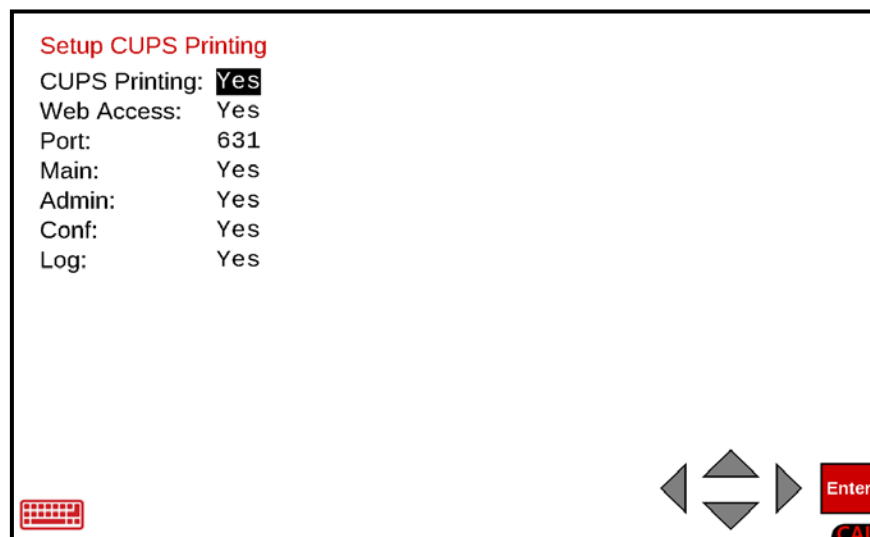
If the settings displayed are acceptable, press the **ENTER** key to save the settings and return to the **Setup Services** screen.

If the current settings are not acceptable, proceed with the following steps.



IMPORTANT! For web configuration and monitoring, the following parameters *must be* set to "Yes": "Web Access:", "Main:", "Admin:", "Conf:", and "Log:".

Setup CUPS Printing



SERVICES, CONT.

CUPS Printing:

With the **Setup CUPS Printing** screen displayed, the current setting for the CUPS Printing: parameter will be shown. If the setting displayed is acceptable, press the ▼ Down Arrow to advance to the next parameter or press the **ENTER** key to return to the **Setup Services** screen.

If the current setting is not acceptable, press the **SPACE** key to toggle the setting between Yes and No.

- Select **Yes** to use (enable) CUPS Printing and press the ▼ Down Arrow to advance to the next parameter or press the **ENTER** key to return to the **Setup Services** screen.
- Select **No** to not use CUPS Printing (or if previously enabled, to disable it) and press the ▼ Down Arrow to advance to the next parameter or press the **ENTER** key to return to the **Setup Services** screen.

Web Access:

With the **Setup CUPS Printing** screen displayed, the current setting for the Web Access: parameter will be shown. If the setting displayed is acceptable, press the ▼ Down Arrow to advance to the next parameter or press the **ENTER** key to return to the **Setup Services** screen.

If the current setting is not acceptable, press the **YES** or **NO** key to toggle the setting between Yes and No.

- Select **Yes** to use allow (enable) Web Access and press the ▼ Down Arrow to advance to the next parameter or press the **ENTER** key to return to the **Setup Services** screen.
- Select **No** to not allow Web Access (or if previously enabled, to disable it) and press the ▼ Down Arrow to advance to the next parameter or press the **ENTER** key to return to the **Setup Services** screen.

Port:

With the **Setup CUPS Printing** screen displayed, the current setting for the Port: parameter will be shown. If the setting displayed is acceptable, press the ▼ Down Arrow to advance to the next parameter or press the **ENTER** key to return to the **Setup Services** screen.

If the current setting is not acceptable, use the numeric keys to enter a new port number and press the ▼ Down Arrow to advance to the next parameter or press the **ENTER** key to return to the **Setup Services** screen.

NOTE: Most users interact with CUPS through its web interface, which runs on port 631. You can access it via any browser by navigating to `http://<IP address of indicator>:631`

For example `http://192.168.0.23:631`.

SERVICES, CONT.

Main:

With the **Setup CUPS Printing** screen displayed, the current setting for the Main: parameter will be shown. If the setting displayed is acceptable, press the ▼ Down Arrow to advance to the next parameter or press the **ENTER** key to return to the **Setup Services** screen.

If the current setting is not acceptable, press the **YES** or **NO** key to toggle the setting between Yes and No.

- Select **Yes** to use (enable) the Web Access Home (main) page viewing and press the ▼ Down Arrow to advance to the next parameter or press the **ENTER** key to return to the **Setup Services** screen.
- Select **No** to not use (disable) Web Access Home (main) page viewing (or if previously enabled, to disable it) and press the ▼ Down Arrow to advance to the next parameter or press the **ENTER** key to return to the **Setup Services** screen.

Admin:

With the **Setup CUPS Printing** screen displayed, the current setting for the Admin: parameter will be shown. If the setting displayed is acceptable, press the ▼ Down Arrow to advance to the next parameter or press the **ENTER** key to return to the **Setup Services** screen.

If the current setting is not acceptable, press the **YES** or **NO** key to toggle the setting between Yes and No.

- Select **Yes** to use (enable) the Web Access Administration page and press the ▼ Down Arrow to advance to the next parameter or press the **ENTER** key to return to the **Setup Services** screen.
- Select **No** to not use (disable) the Web Access Administration page viewing (or if previously enabled, to disable it) and press the ▼ Down Arrow to advance to the next parameter or press the **ENTER** key to return to the **Setup Services** screen.

NOTE: Enabling the Web Access Administration page allows you to add, find, and manage existing “Printers”, add and manage “Classes”, and manage printing “Jobs”.

SERVICES, CONT.

Conf:

With the **Setup CUPS Printing** screen displayed, the current setting for the Conf: parameter will be shown. If the setting displayed is acceptable, press the ▼ Down Arrow to advance to the next parameter or press the **ENTER** key to return to the **Setup Services** screen.

If the current setting is not acceptable, press the **YES** or **NO** key to toggle the setting between Yes and No.

- Select **Yes** to allow (enable) using the Web Access “Edit Configuration File” for the CUPS Scheduler and press the ▼ Down Arrow to advance to the next parameter or press the **ENTER** key to return to the **Setup Services** screen.
- Select **No** to disallow (disable) using the Web Access “Edit Configuration File” for the CUPS Scheduler (or if previously enabled, to disable it) and press the ▼ Down Arrow to advance to the next parameter or press the **ENTER** key to return to the **Setup Services** screen.

Log:

With the **Setup CUPS Printing** screen displayed, the current setting for the Log: parameter will be shown. If the setting displayed is acceptable, press the ▼ Down Arrow to advance to the next parameter or press the **ENTER** key to return to the **Setup Services** screen.

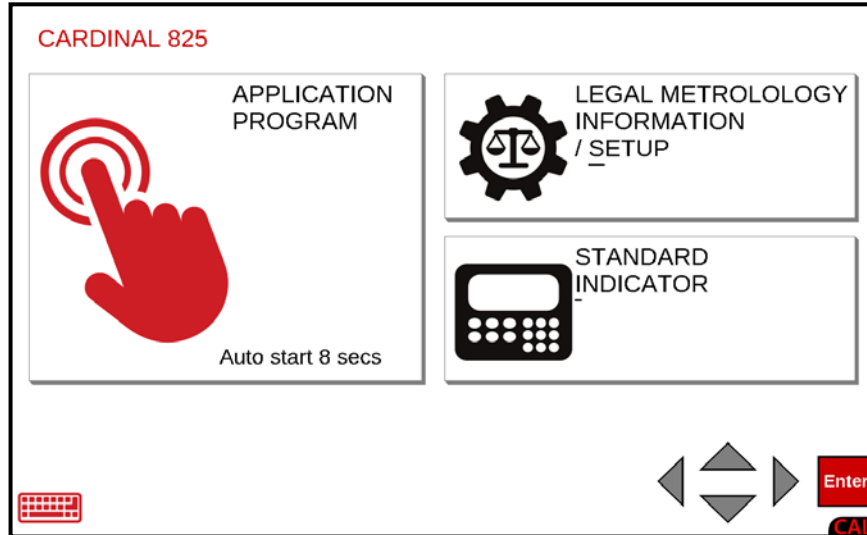
If the current setting is not acceptable, press the **YES** or **NO** key to toggle the setting between Yes and No.

- Select **Yes** to allow the Web Access to create a “Log Messages” file and press the **ENTER** key to return to the **Setup Services** screen.
- Select **No** to disallow the Web Access from creating a “Log Messages” file and press the **ENTER** key to return to the **Setup Services** screen.

DIAGNOSTICS

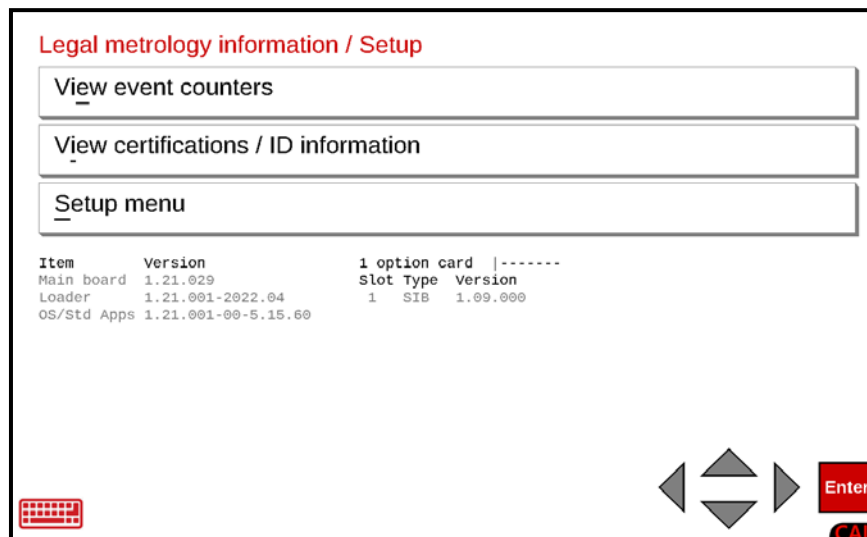
The 825 is equipped with diagnostic software that tests various portions of the indicator's circuitry and functions and verifies proper operation.

4. Press the Push Button Power Switch on the rear enclosure of the 825 to turn it on. The display will perform a short self-test and then change to the **Start-Up** screen.



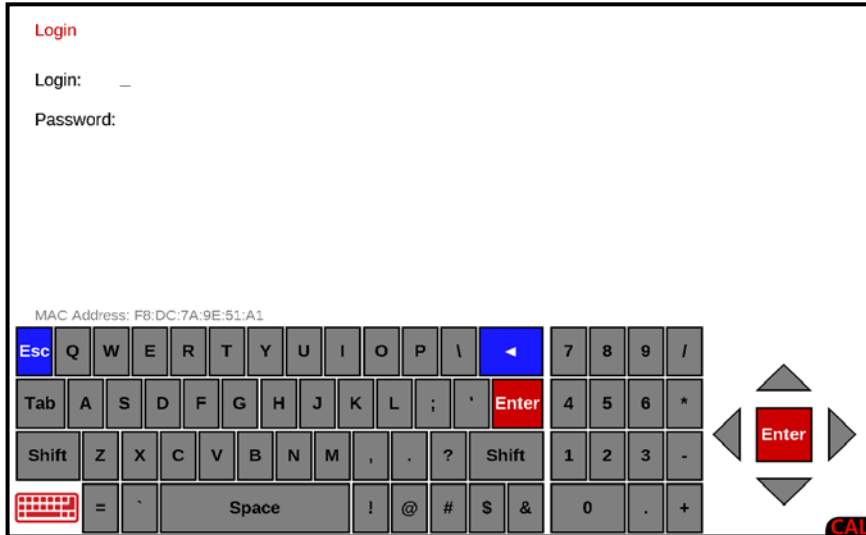
NOTE: When the 825 is initially started, an Auto-start countdown beginning at 8 seconds will appear on the APPLICATION PROGRAM selection. When the countdown is complete, the application program mode will automatically start.

5. With the **Start-Up** screen displayed, press the LEGAL METROLOGY INFORMATION / SETUP selection on the touchscreen or use the Qwerty keyboard and press the **S** key to select LEGAL METROLOGY INFORMATION / SETUP or use the Navigation Keys ► Right Arrow to (highlight) the selection and press the **ENTER** key.
6. The display will change to show the **Legal metrology information / Setup** screen.



DIAGNOSTICS, CONT.

With the **Legal metrology information / Setup** screen displayed, press the Navigation Keys **▼** Down Arrow to (highlight) the Setup menu option and press the **ENTER** key or use the Qwerty keyboard and press the **S** key to select the Setup menu option. The display will change to show the **Login** screen and prompt for the Login and Password.

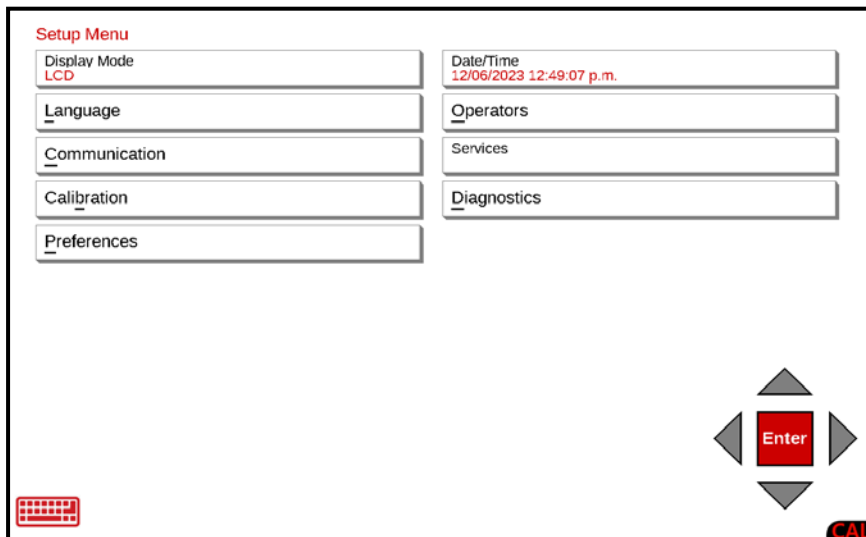


4. With the **Login** screen and prompt displayed, use the Qwerty keyboard to enter the Login and press the **▼** Down Arrow to advance to the Password prompt.
5. Enter the Password using the numeric keys and press the **ENTER** key to proceed with Setup.



NOTE: The 825 will arrive from the factory with the calibration access locked by the “Login” and “Password” prompts protection. The factory default Login and Password are “ADMIN” and “81440”.

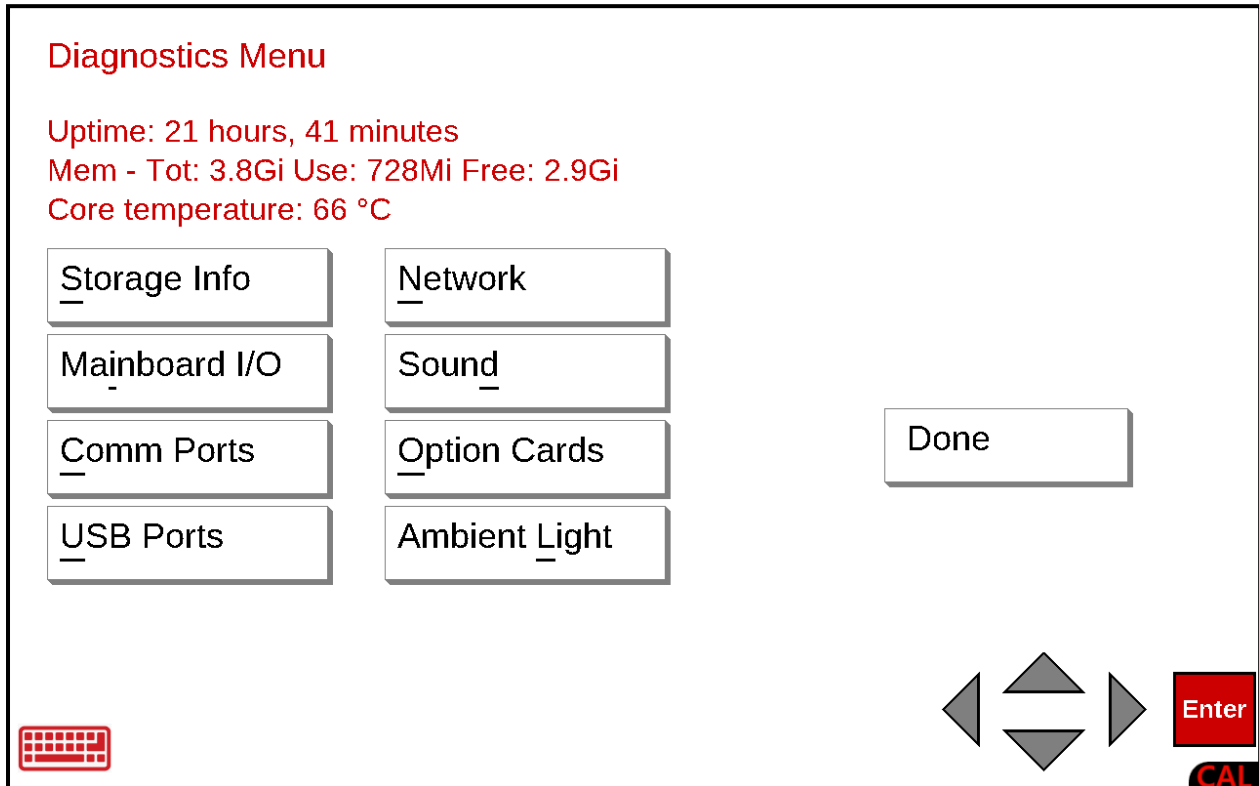
6. After logging in, the display will change to the **Setup Menu** screen.



DIAGNOSTICS, CONT.

Diagnostics Menu

With the **Setup Menu** screen displayed, press the Diagnostics menu option, or use the Qwerty keyboard and press the **D** key to select Diagnostics, or use the Navigation Keys to select (highlight) Diagnostics and press the **ENTER** key. The display will change to show the **Diagnostics Menu** screen.



With the **Diagnostics Menu** screen displayed, the indicator Uptime (a measure of how long it has been on and available), the Memory status, and the Core (internal) temperature of the indicator will be shown.

After viewing the uptime, memory status and core temperature is all that is required, press **Done** or **Enter** on the touchscreen, or use the Navigation Keys ◀ Left Arrow or use the Qwerty keyboard **Esc** key to exit viewing and return to the **Setup Menu** screen.

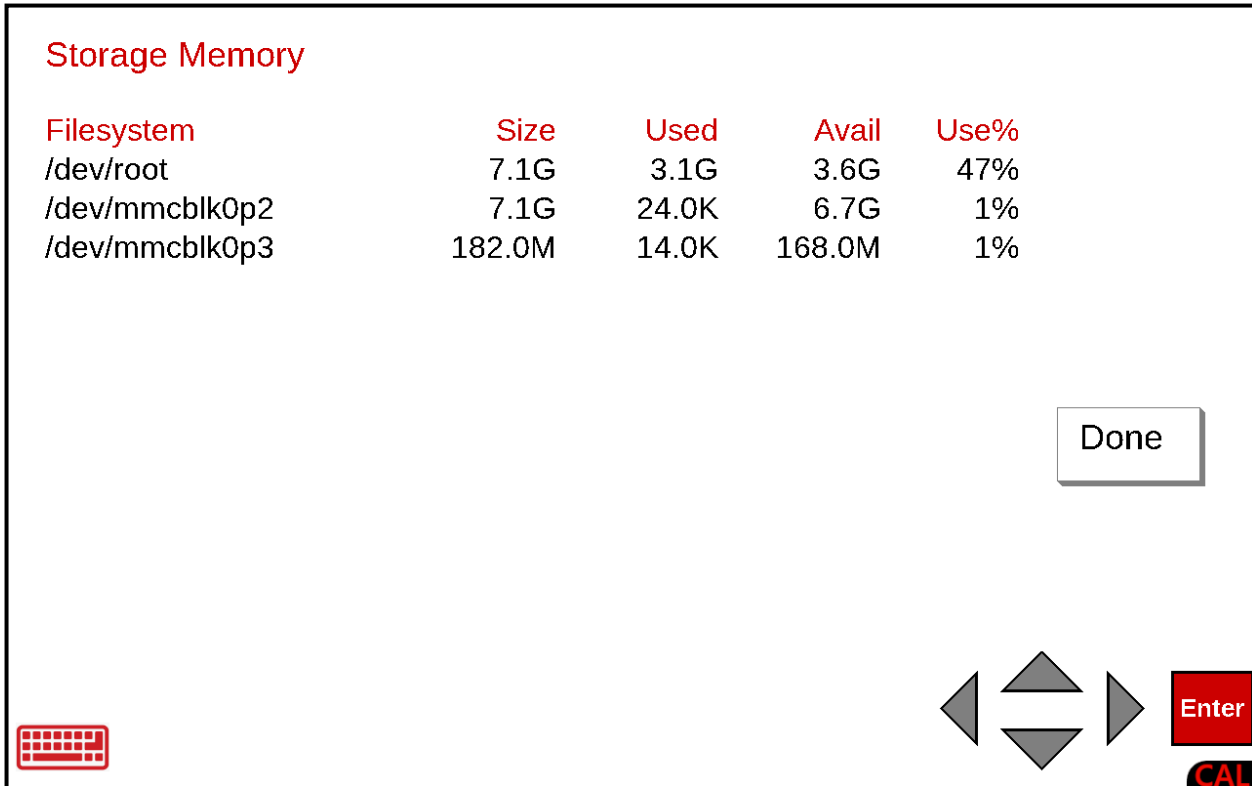
Otherwise, press the test to perform on the menu option, or use the Qwerty keyboard and press the appropriate letter to select the test to perform, or use the Navigation Keys to select (highlight) the test to perform and press the **Enter** key.

- | | |
|---|-----------------------------------|
| S = <u>S</u> torage Info | N = <u>N</u> etwork |
| i = <u>M</u> ainboard I/O (lowercase i) | d = <u>S</u> ound (lowercase d) |
| C = <u>C</u> omm Ports | O = <u>O</u> ption Cards |
| U = <u>U</u> SB Ports | L = <u>A</u> mbient <u>L</u> ight |

DIAGNOSTICS, CONT.

Storage Info

With the **Diagnostics Menu** screen displayed, press the S Storage Info menu option, or use the Qwerty keyboard and press the **S** key to select Storage Info, or use the Navigation Keys to select (highlight) S Storage Info and press the **ENTER** key. The display will change to show the **Storage Memory** screen.



The screenshot shows the 'Storage Memory' screen with a table of filesystem information. The table has five columns: Filesystem, Size, Used, Avail, and Use%. Below the table is a 'Done' button, a keyboard icon, and navigation arrows. A red 'Enter' button and a 'CAL' label are also visible at the bottom right.

Filesystem	Size	Used	Avail	Use%
/dev/root	7.1G	3.1G	3.6G	47%
/dev/mmcblk0p2	7.1G	24.0K	6.7G	1%
/dev/mmcblk0p3	182.0M	14.0K	168.0M	1%

With the **Storage Memory** screen displayed, the Filesystem name, Size, amount of memory used, the remaining amount of memory available, and the percentage of memory used will be shown.

After viewing the storage memory information, press **Done** or **Enter** on the touchscreen, or use the Navigation Keys ◀ Left Arrow or use the Qwerty keyboard **Esc** key to exit viewing and return to the **Diagnostics Menu** screen.

DIAGNOSTICS, CONT.

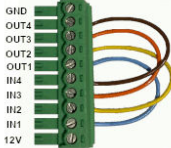
Mainboard I/O

With the **Diagnostics Menu** screen displayed, press the Mainboard I/O menu option, or use the Qwerty keyboard and press the **i** (lowercase i) key to select Mainboard I/O, or use the Navigation Keys to select (highlight) Mainboard I/O and press the **ENTER** key. The display will change to show the **Test Mainboard I/O** screen.


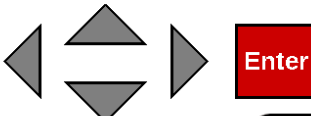

Test Mainboard I/O

I/O Code From: **0**
I/O Code To: **15**

A successful test requires a loopback connection
OUT1 → IN1, OUT2 → IN2, OUT3 → IN3, OUT4 → IN4
such as:

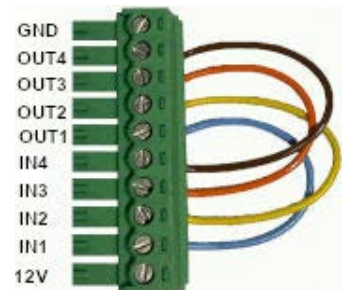


Enter the starting code
out1=1,out2=2,out3=4,out4=8
example 5=out1 and 3





IMPORTANT! To test the Mainboard I/O, a loopback connector is required. For example, OUT1 to IN1, OUT2 to IN2, OUT3 to IN3, etc.. Refer to the adjacent illustration to construct a Mainboard I/O loopback connector.



Test Mainboard I/O

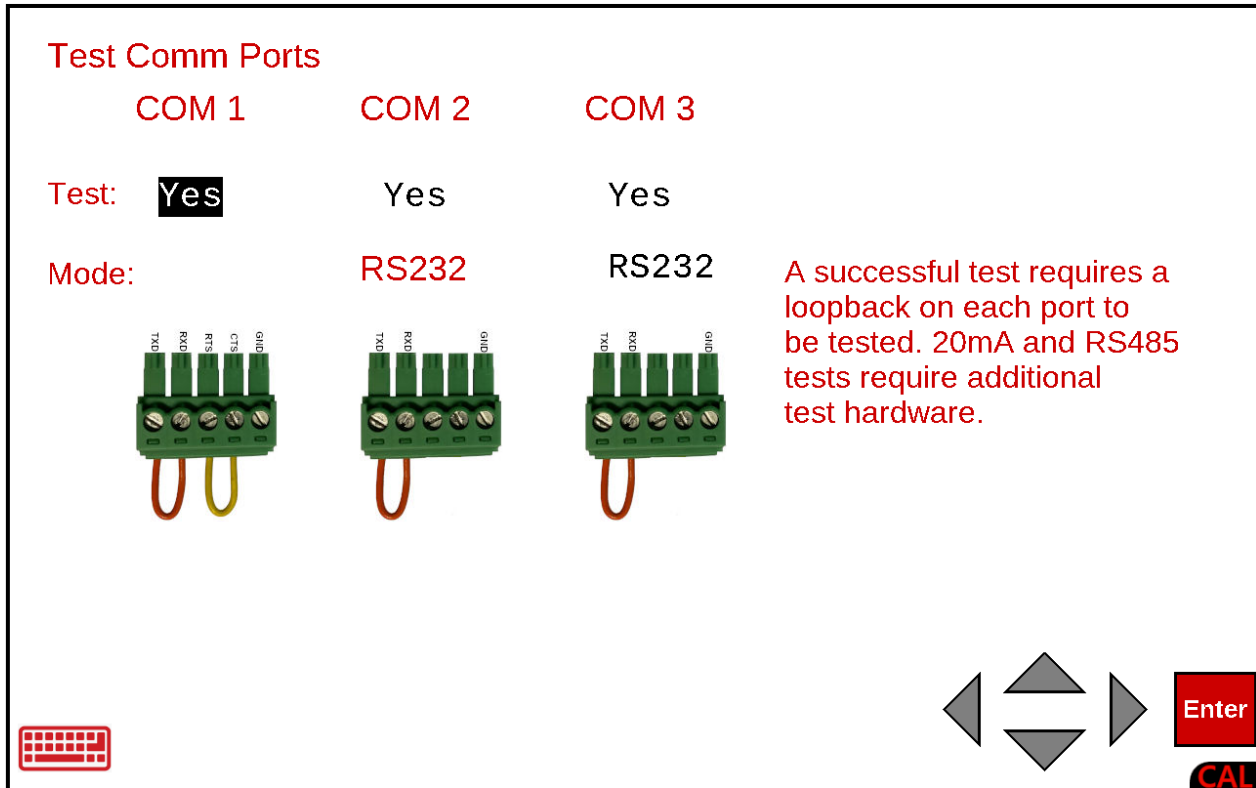
With the **Test Mainboard I/O** screen displayed, use the numeric keys to enter the values for the range of the I/O Code to start From and the I/O Code To stop at.

Allowable values are **0** to **15**.

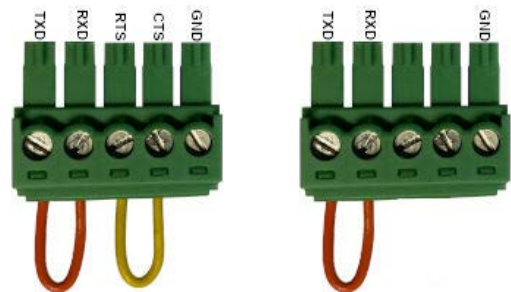
DIAGNOSTICS, CONT.

Comm Ports

With the **Diagnostics Menu** screen displayed, press the Comm Ports menu option, or use the Qwerty keyboard and press the **C** key to select Comm Ports, or use the Navigation Keys to select (highlight) Comm Ports and press the **ENTER** key. The display will change to show the **Test Comm Ports** screen.



IMPORTANT! To test the Comm Ports, a loopback connector is required. Refer to the adjacent illustrations to construct a Comm Port loopback connector.



Test Comm Ports

With the **Test Comm Ports** screen displayed, use the Navigation Keys to select the Comm Port to test and then press the **SPACE** key to toggle the setting between Yes and No.

Use the Navigation Keys to select the Mode for COM 2 and COM 3 and then press the **SPACE** key to toggle the setting between RS232 and RS485.

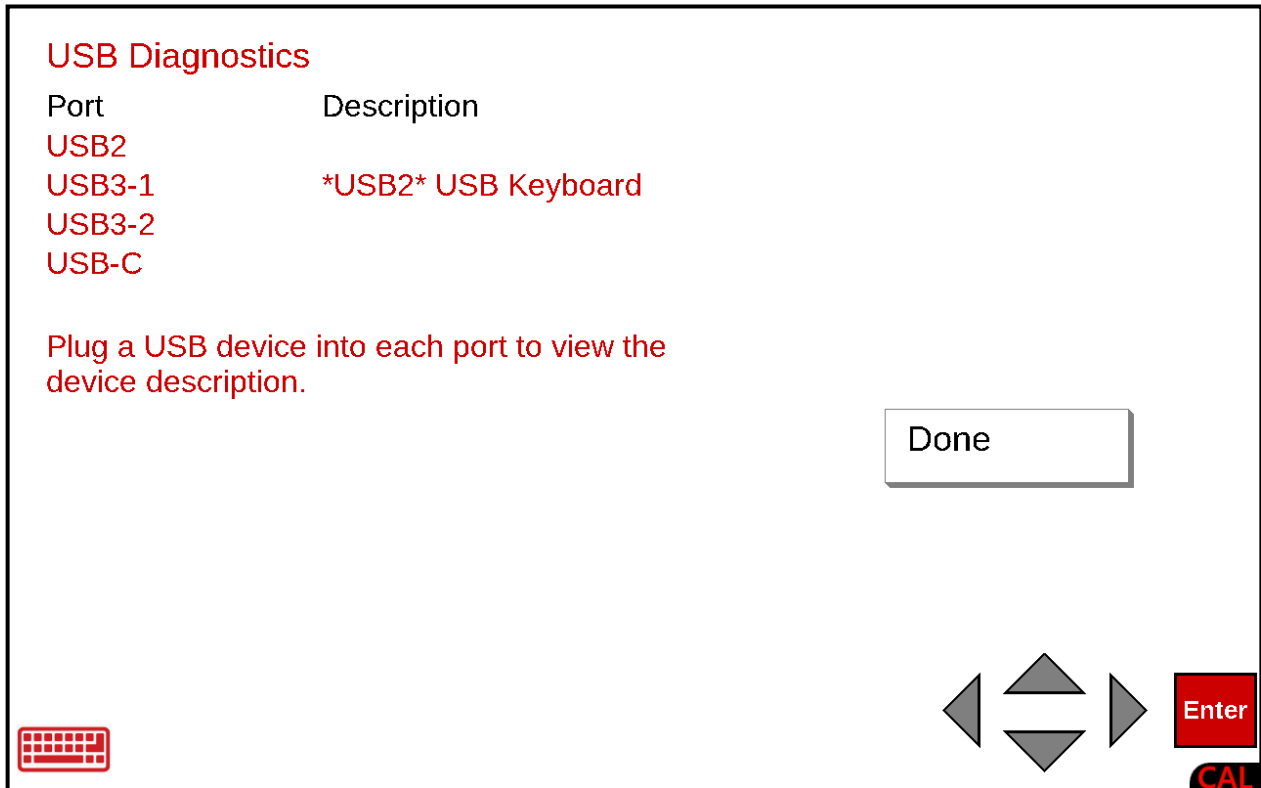
Press the **ENTER** key to begin the test.

After completing the Comm Ports test, press **Done** or **Enter** on the touchscreen, or use the Navigation Keys ◀ Left Arrow to return to the **Test Comm Ports** screen and use the Qwerty keyboard **Esc** key to return to the **Diagnostics Menu** screen.

DIAGNOSTICS, CONT.

USB Ports

With the **Diagnostics Menu** screen displayed, press the Usb Ports menu option, or use the Qwerty keyboard and press the **U** key to select Usb Ports, or use the Navigation Keys to select (highlight) Usb Ports and press the **ENTER** key. The display will change to show the **Test USB Ports** screen.



USB Diagnostics

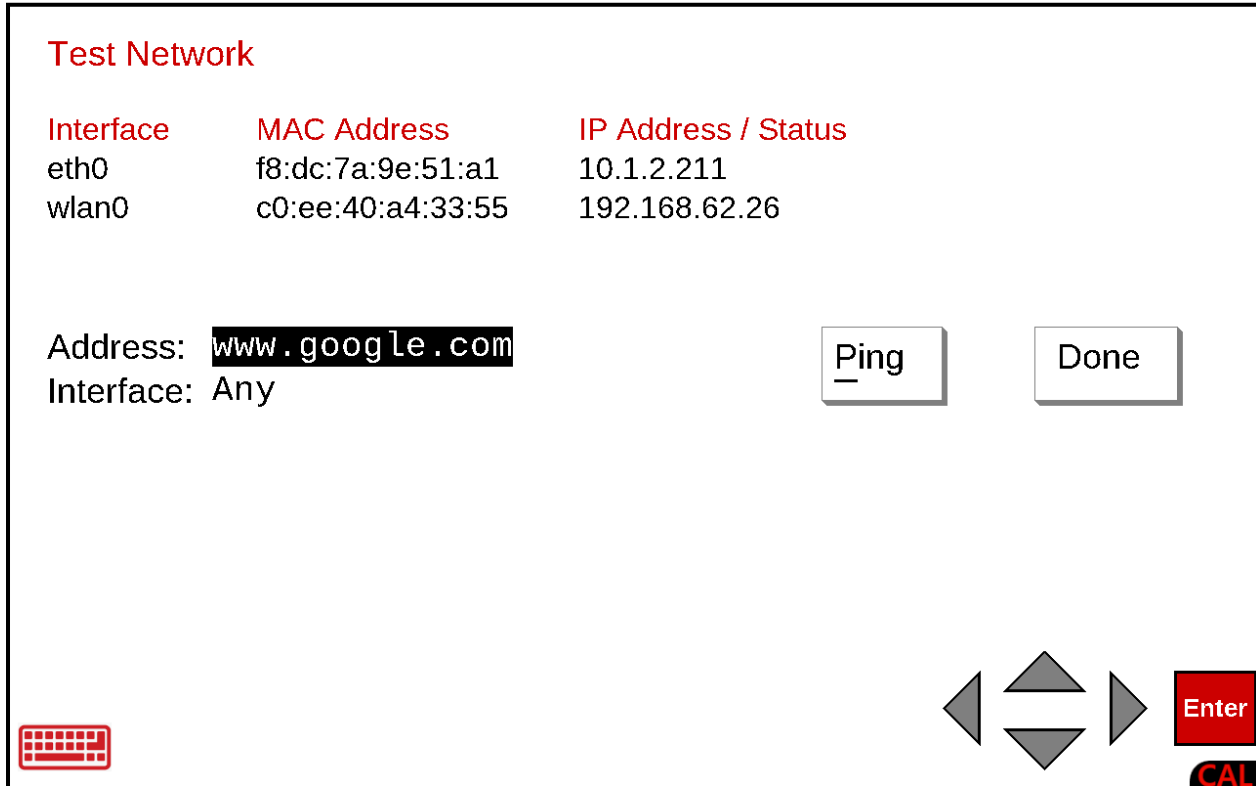
With the **USB Diagnostics** screen displayed, plug a USB device into each port to view the device description.

After viewing the device description of the device plugged into the USB ports, press **Done** or **Enter** on the touchscreen, or use the Navigation Keys ◀ Left Arrow or use the Qwerty keyboard **Esc** key to exit viewing and return to the **Diagnostics Menu** screen.

DIAGNOSTICS, CONT.

Network

With the **Diagnostics Menu** screen displayed, press the Network menu option, or use the Qwerty keyboard and press the **N** key to select Network, or use the Navigation Keys to select (highlight) Network and press the **ENTER** key. The display will change to show the **Test Network** screen.



Address

With the **Test Network** screen displayed, the default address (www.google.com) to Ping to the network will be displayed.

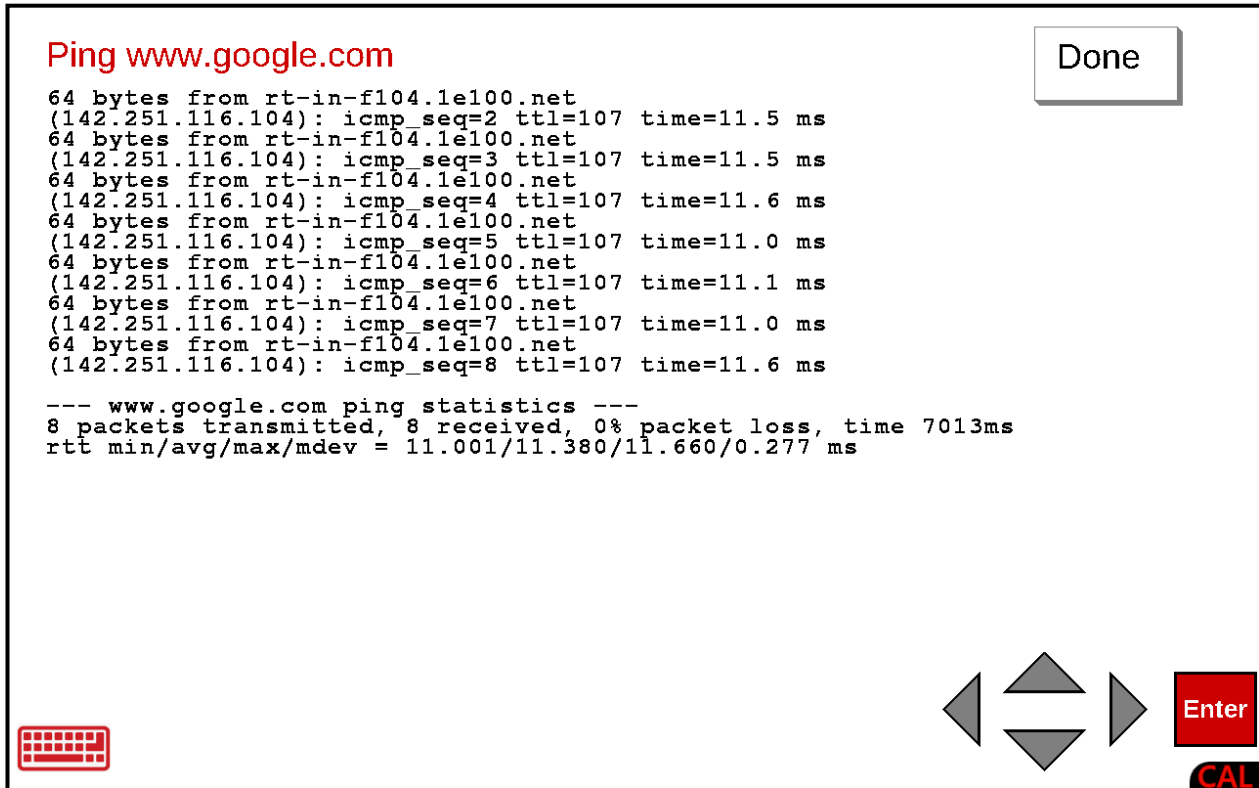
If the setting displayed is acceptable, press the **Ping** key to begin the test (ping the displayed address) to test the network.

If the current setting is not acceptable, use the Qwerty keyboard to enter a different address and press the **Ping** key to begin the test (ping the address entered) to test the network.

NOTE: Refer to the example screen on the next page for an illustration of a completed Network Ping Test.

DIAGNOSTICS, CONT.

Network, Cont.



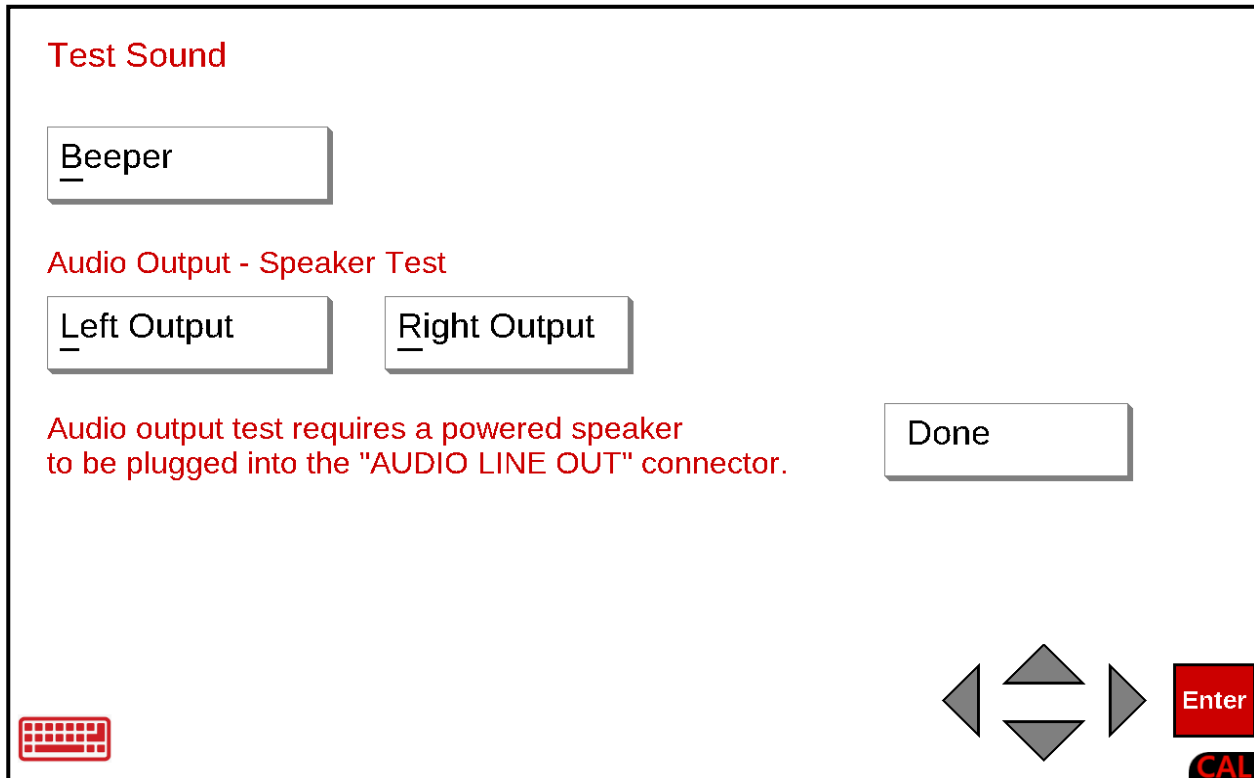
After completing the Network test, press **Done** or **Enter** on the touchscreen, or use the Navigation Keys ◀ Left Arrow to return to the **Test Network** screen.

Press **Done** or **Enter** on the touchscreen or use the Navigation Keys ◀ Left Arrow or use the Qwerty keyboard **Esc** key to return to the **Diagnostics Menu** screen.

DIAGNOSTICS, CONT.

Sound

With the **Diagnostics Menu** screen displayed, press the **Sound** menu option, or use the Qwerty keyboard and press the **d** (lowercase d) key to select **Sound**, or use the Navigation Keys to select (highlight) **Sound** and press the **ENTER** key. The display will change to show the **Test Sound** screen.



IMPORTANT! To test the Sound, a powered speaker must be plugged into the AUDIO LINE OUT connector (J14) on the mainboard. Refer to Figure No. 22 for the location of the audio line out connector J14.

Beeper

With the **Test Sound** screen displayed, press the **Beeper** key on the touchscreen or use the Qwerty keyboard and press the **B** key to test the indicator beeper.

Left Output

With a powered speaker plugged into the audio line out connector J14, press the **Left Output** key on the touchscreen or use the Qwerty keyboard and press the **L** key to test the audio output left channel.

Right Output

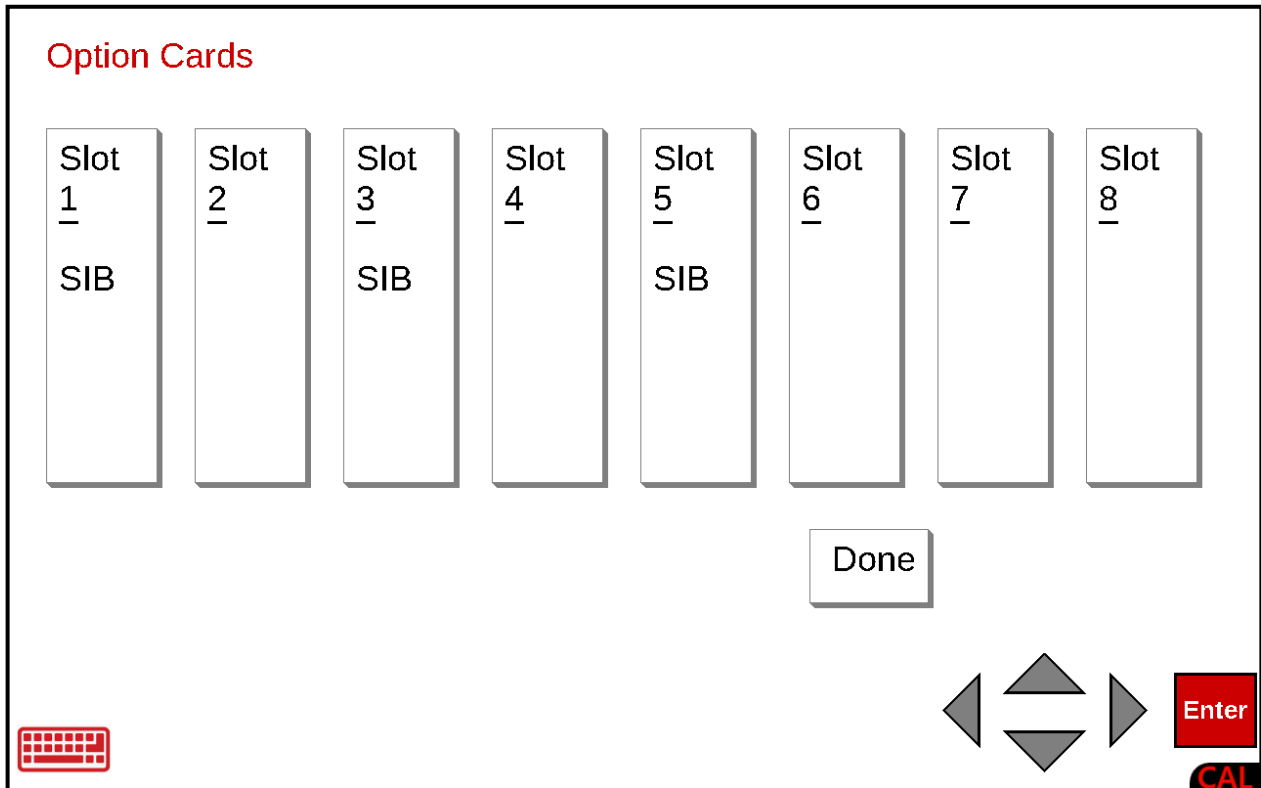
With a powered speaker plugged into the audio line out connector J14, press the **Right Output** key on the touchscreen or use the Qwerty keyboard and press the **R** key to test the audio output right channel.

After completing the Sound test, press **Done** or **Enter** on the touchscreen, or use the Navigation Keys ◀ Left Arrow, or use the Qwerty keyboard **Esc** key to return to the **Diagnostics Menu** screen.

DIAGNOSTICS, CONT.

Option Cards

With the **Diagnostics Menu** screen displayed, press the **Option Cards** menu option, or use the Qwerty keyboard and press the **O** key to select **Option Cards**, or use the Navigation Keys to select (highlight) **Option Cards** and press the **ENTER** key. The display will change to show the **Option Cards** screen.



Option Cards

With the **Option Cards** screen displayed, the cards installed (the card description will be displayed in the slot) will be shown.

Press the Slot on the touchscreen to display the firmware version of the card.

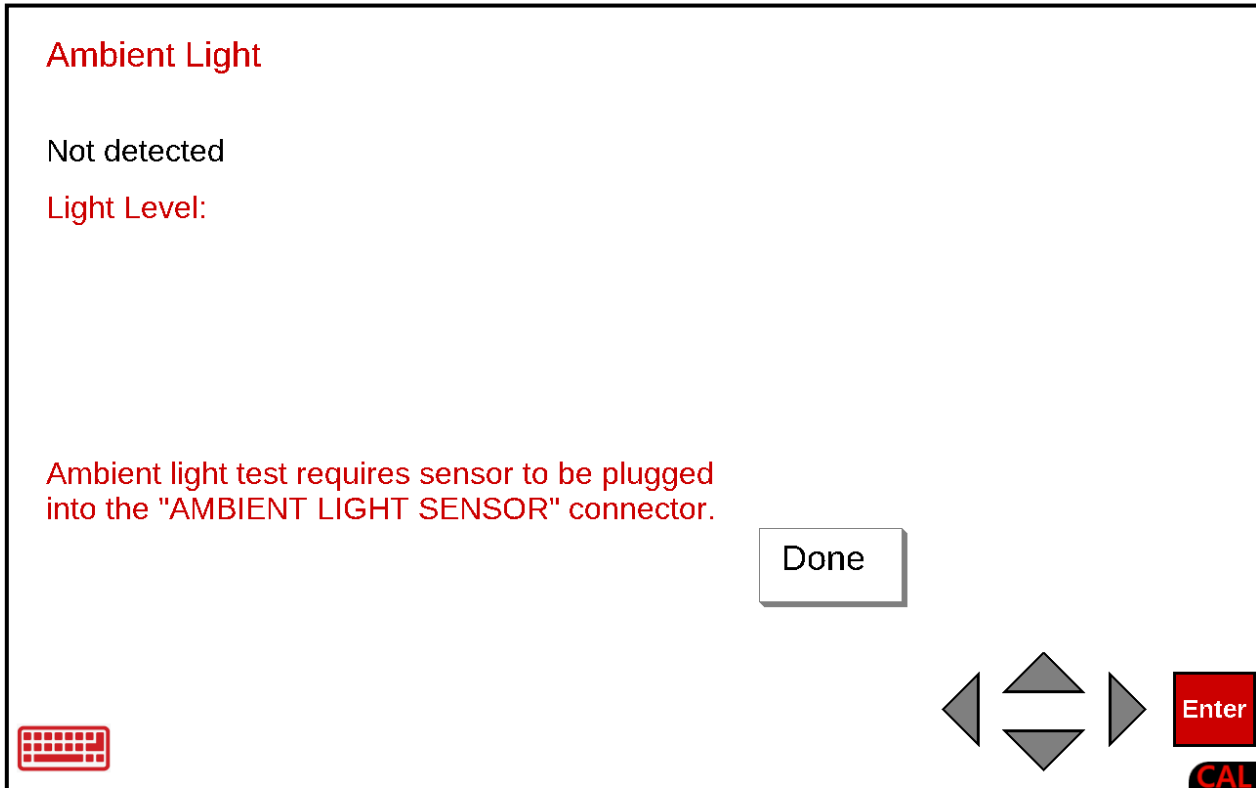
After viewing the option card firmware version, press **Done** or **Enter** on the touchscreen, or use the Navigation Keys ◀ Left Arrow or use the Qwerty keyboard **Esc** key to exit viewing and return to the **Option Cards** screen.

Press **Done** or **Enter** on the touchscreen, or use the Navigation Keys ◀ Left Arrow or use the Qwerty keyboard **Esc** key to exit viewing and return to the **Diagnostics Menu** screen.

DIAGNOSTICS, CONT.

Ambient Light

With the **Diagnostics Menu** screen displayed, press the Ambient Light menu option, or use the Qwerty keyboard and press the **L** key to select Ambient Light, or use the Navigation Keys to select (highlight) Ambient Light and press the **ENTER** key. The display will change to show the **Ambient Light** screen.



IMPORTANT! To test the Ambient Light, a light sensor must be plugged into the AMBIENT LIGHT SENSOR connector (P19) on the mainboard. Refer to Figure No. 22 for the location of the ambient light sensor connector P19.

Ambient Light

After viewing the Ambient Light Level, press **Done** or **Enter** on the touchscreen, or use the Navigation Keys ◀ Left Arrow or use the Qwerty keyboard **Esc** key to exit viewing and return to the **Diagnostics Menu** screen.

DIAGNOSTICS, CONT.

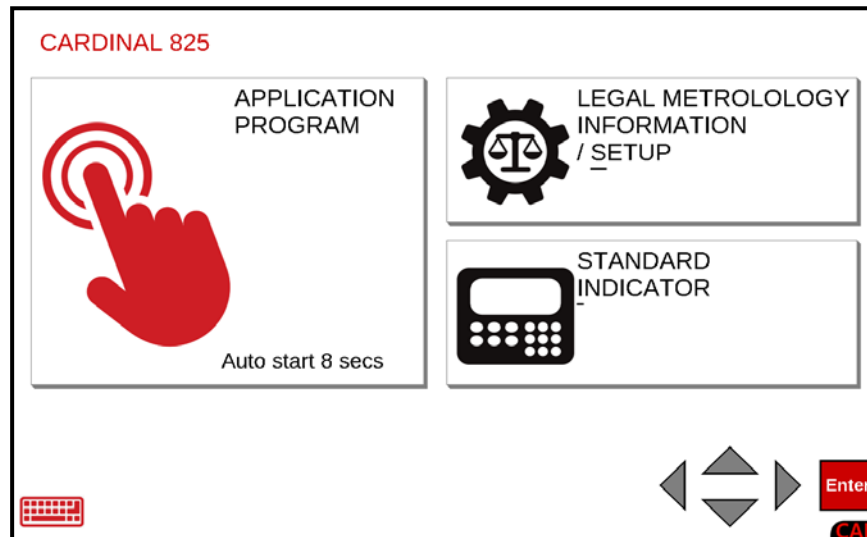
Return to Normal Operations

To return to the Weight Screen and resume normal weighing operations:

With the **Diagnostics Menu** screen displayed, press **Done** or **Enter** on the touchscreen or use the Navigation Keys ◀ Left Arrow or use the Qwerty keyboard **Esc** key to return to the **Setup Menu** screen.

Next, with the **Setup Menu** screen displayed, press the Navigation Keys ◀ Left Arrow or use the Qwerty keyboard **Esc** key to return to the **Legal metrology information / Setup** screen.

Finally, with the **Legal metrology information / Setup** screen displayed, press the Navigation Keys ◀ Left Arrow or use the Qwerty keyboard **Esc** key to return to the **Startup** screen.

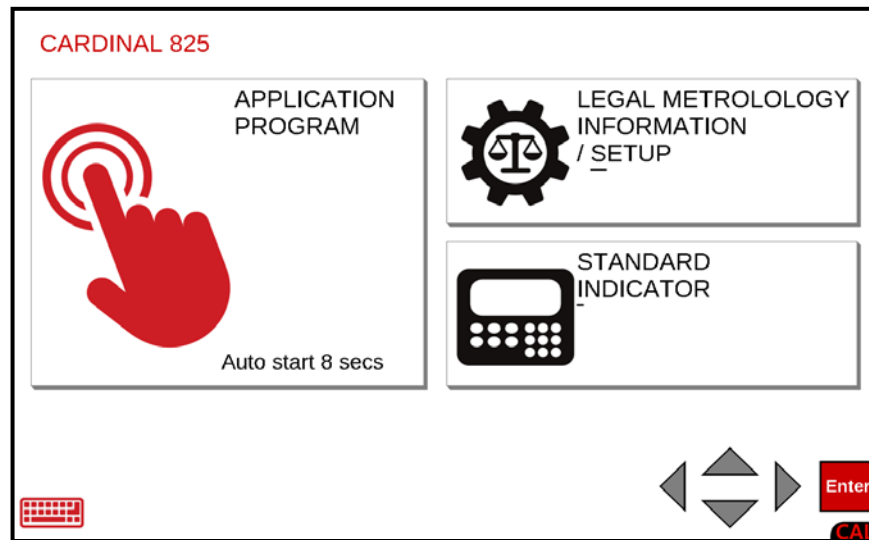


EVENT COUNTERS

A Category 1 Event Counter is provided on the 825 with two counters that increment when a change is made to features that are required by NTEP or OIML to be sealed. One counter is designated for calibration parameters and one is designated for configuration changes as required in NCWM Publication 14, 2007. Each event counter has the capacity to record 999 changes. The data for the counters is maintained in non-volatile memory and can be viewed by a weights and measures inspector. When selected, the display will show the number of changes and the date and time of the last update to the Calibrate and Config counters.

To View the Event Counters

Press the Push Button Power Switch on the rear enclosure (see Figure No. 2) of the 825 to turn it on. The display will perform a short self-test and then change to the **Start-Up** screen.



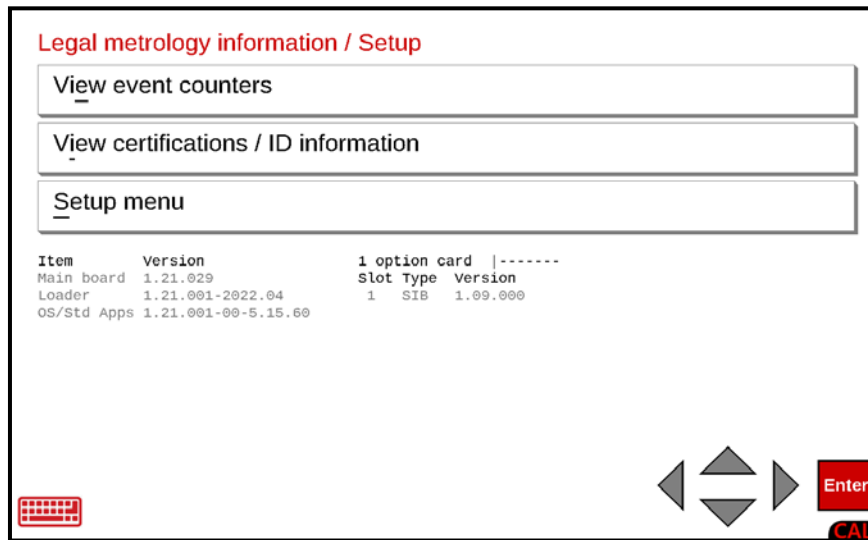
NOTE: When the 825 is initially started, an Auto-start countdown beginning at 8 seconds will appear on the APPLICATION PROGRAM selection. When the countdown is complete, the application program mode will automatically start.

With the **Start-Up** screen displayed, press the LEGAL METROLOGY INFORMATION / SETUP selection on the touchscreen or use the Qwerty keyboard and press the **S** key to select LEGAL METROLOGY INFORMATION / SETUP or use the Navigation Keys ► Right Arrow to (highlight) the selection and press the **ENTER** key.

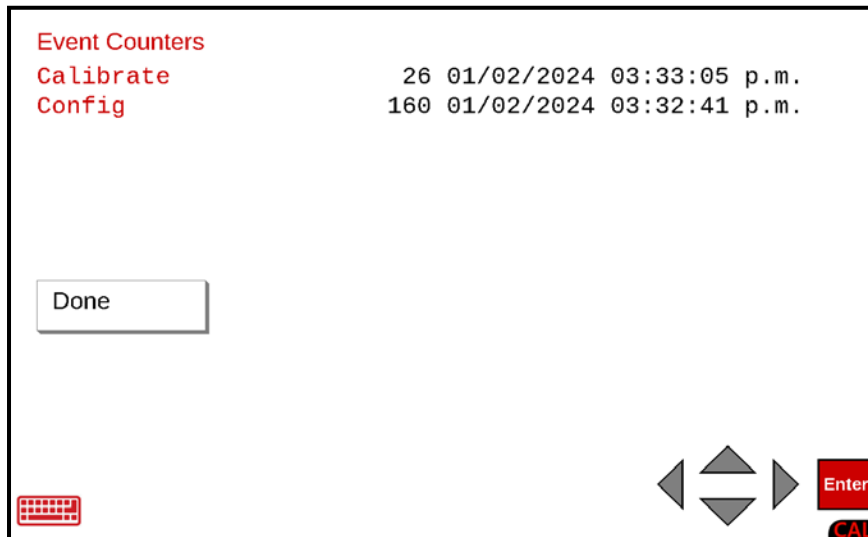
The display will change to show the **Legal metrology information / Setup** screen.

EVENT COUNTERS, CONT.

To View the Event Counters, Cont.



With the **Legal metrology information / Setup** screen displayed, press the “View event counters” selection on the touchscreen or use the Qwerty keyboard and press the **e** key to select the View event counters menu option. The display will change to show the **Event Counters** screen.

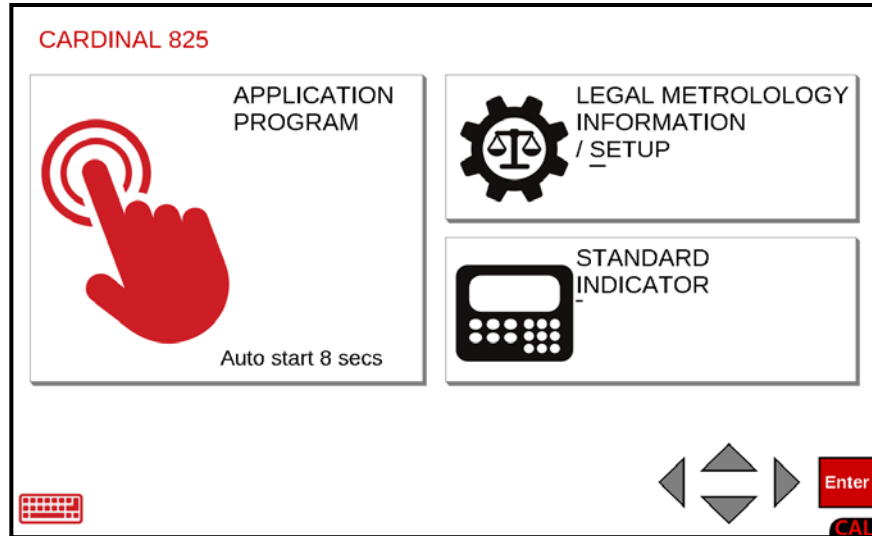


After viewing the Event Counters, press **Done** or **Enter** on the touchscreen, or use the Navigation Keys ◀ Left Arrow or use the Qwerty keyboard **Esc** key to exit viewing and return to the **Legal metrology information / Setup** screen.

EVENT COUNTERS, CONT.

Return to Normal Operations

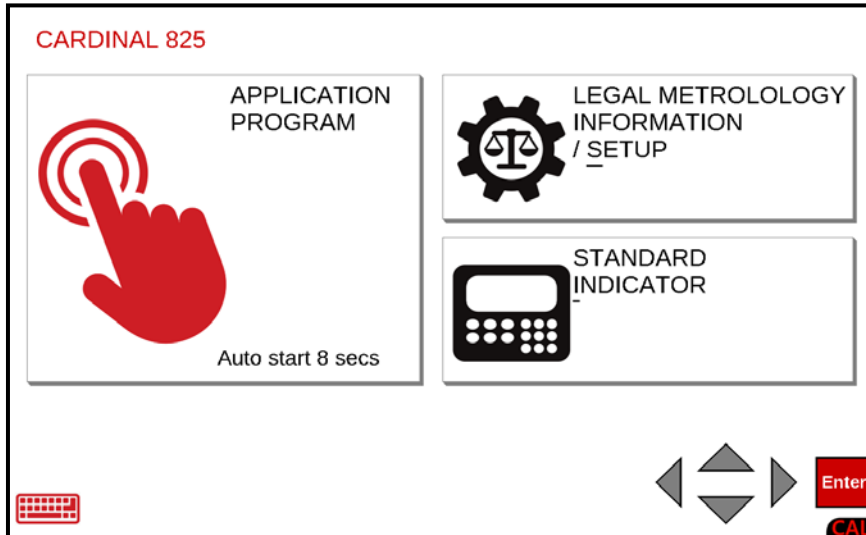
To return to the Weight Screen and resume normal weighing operations, with the **Legal metrology information / Setup** screen displayed, press the Navigation Keys ◀ Left Arrow or use the Qwerty keyboard **Esc** key to return to the **Startup** screen.



CERTIFICATIONS / ID INFORMATION

To View the Certifications / ID Information

Press the Push Button Power Switch on the rear enclosure (see Figure No. 2) of the 825 to turn it on. The display will perform a short self-test and then change to the **Start-Up** screen.



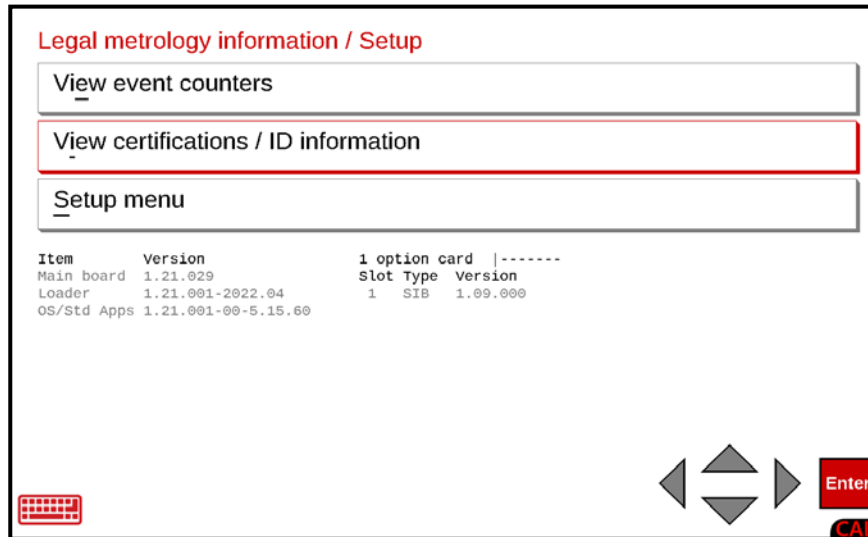
NOTE: When the 825 is initially started, an Auto-start countdown beginning at 8 seconds will appear on the APPLICATION PROGRAM selection. When the countdown is complete, the application program mode will automatically start.

With the **Start-Up** screen displayed, press the LEGAL METROLOGY INFORMATION / SETUP selection on the touchscreen or use the Qwerty keyboard and press the **S** key to select LEGAL METROLOGY INFORMATION / SETUP or use the Navigation Keys ► Right Arrow to (highlight) the selection and press the **ENTER** key.

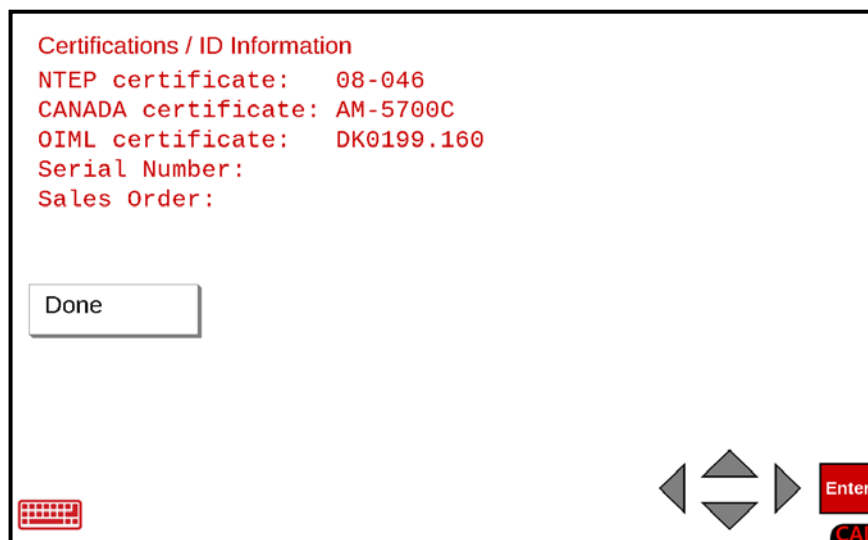
The display will change to show the **Legal metrology information / Setup** screen.

CERTIFICATIONS / ID INFORMATION, CONT.

To View the Certifications / ID Information, Cont.



With the **Legal metrology information / Setup** screen displayed, press the “View certifications / ID information” selection on the touchscreen or use the Qwerty keyboard and press the **i** key to select the View certifications / ID information menu option or use the Navigation Keys to select (highlight) View certifications / ID information and press the **ENTER** key. The display will change to show the **Certifications / ID information** screen.

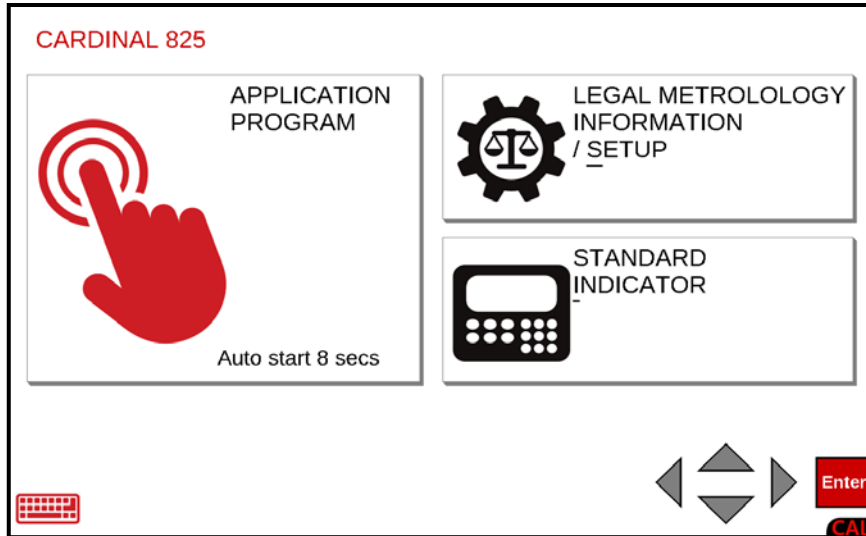


After viewing the Certifications / ID Information, press **Done** or **Enter** on the touchscreen, or use the Navigation Keys **◀** Left Arrow or use the Qwerty keyboard **Esc** key to exit viewing and return to the **Legal metrology information / Setup** screen.

CERTIFICATIONS / ID INFORMATION, CONT.

Return to Normal Operations

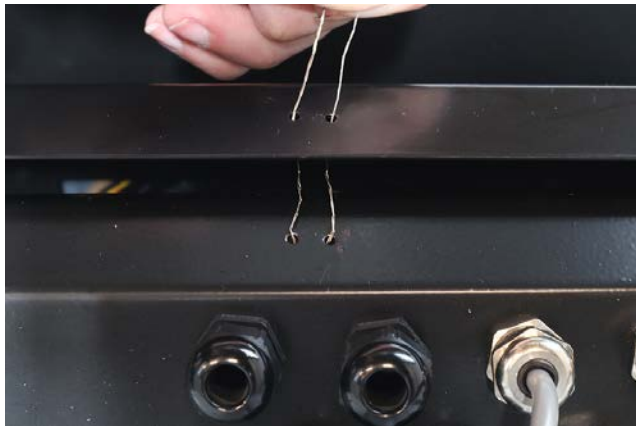
To return to the Weight Screen and resume normal weighing operations, with the **Legal metrology information / Setup** screen displayed, press the Navigation Keys ◀ Left Arrow or use the Qwerty keyboard **Esc** key to return to the **Startup** screen.



LOCK AND WIRE SECURITY SEAL INSTALLATION

If your Model 825 Desktop Weight Indicator is used in a commercial application and your local metrology laws require the use of physical sealing, a lock and wire security seal can be installed to prevent the front panel from being lowered from the main enclosure to gain access to the calibration jumper (J11) thereby preventing unauthorized access to the calibration adjustments. Refer to the instructions below for the installation of the security seal.

1. Remove the two (2) thumbscrews securing the hinged front display panel to the base enclosure. Next, pull forward on the front display panel until it is open enough to insert a wire through the two (2) holes in the base enclosure and up through the hinged front display panel.
2. Next, while holding the wire (to prevent it from falling into the base enclosure) lower the front display panel until it is against the base enclosure.



Step One



Step Two

3. While continuing to hold the wire, install the lock over both ends of the wire.
4. Slide the lock down over the wires until it is against the enclosure and then seal it. Re-install the two (2) thumbscrews remove earlier to secure the hinged front panel to the base enclosure.



Step Three



Step Four

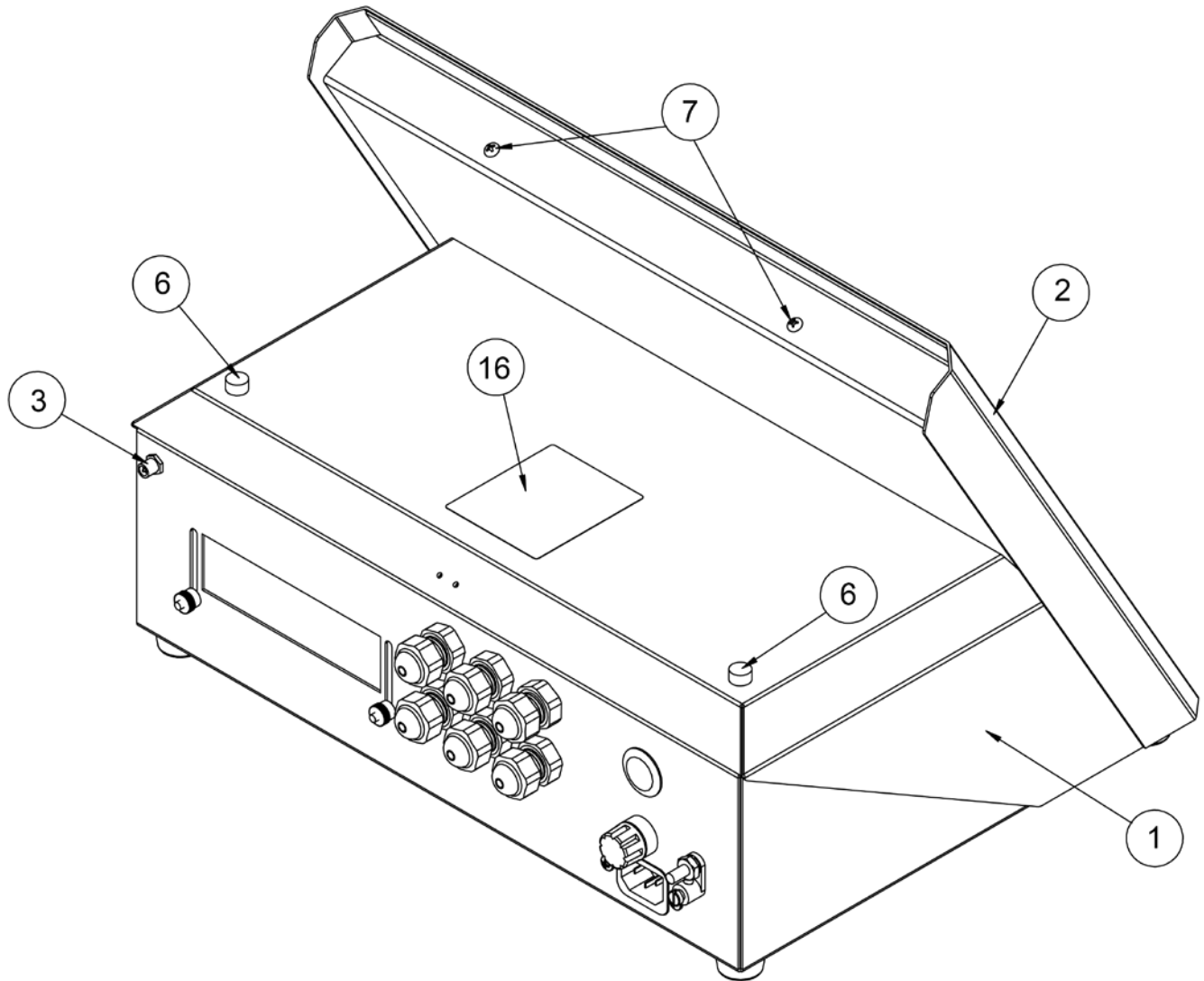
PARTS IDENTIFICATION

Final Assembly Parts List

ITEM NO.	QTY	PART NUMBER	DESCRIPTION
1	1	8545-1180-0A	SUB-ASSEMBLY, REAR ENCLOSURE, 825X-D
2	1	8545-1179-0A	825 DESKTOP, SCREEN ASSEMBLY
3	1	8545-1016-1A	PCB ASSEMBLY, 825 CONTROLLER W/ MODULE
4	1	8545-1051-0A	825 BOARD CHASSIS ASSEMBLY
5	10	6021-0423	SCW, PAN-HEAD, MACHINE-SCW, 04-40 X 0.250
6	2	6021-1065	SCW, THUMB, MACHINE-SCW, 06-32 X 0.375
7	4	6024-1022	WASHER, FLAT, #6 TYPE A, Z-PLATE
8	4	6540-0032	FOOT, RUBBER, 0.88 DIA X 0.40 H, BLACK
9	1	6600-0825	CABLE, ANTENNA, 6" WITH U.FL & SMA CONNECTORS
10	4	6680-0004	WASHER, LOCK, INT TOOTH, #6 TYPE A, Z-PL
11	1	6980-0014	CABLE TIE, 4 IN, WHITE
12	1	8545-C803-0A	PCB, SCALE INPUT, 825 INDICATOR
	1	8545-0880-0A	PCB ASSEMBLY, 825-DLC DIGITAL LOAD CELL INTERFACE
13	4	6013-0039	NUT, #6-32, Z/P
14	4	6021-0106	SCREW, PAN HEAD, SELF TAP, 6-32 X 0.375
15	2	6680-0026	WASHER, LOCK, INT TOOTH, #4 TYPE A, Z-PL
16	1	593GR986	SERIAL TAG ASSEMBLY

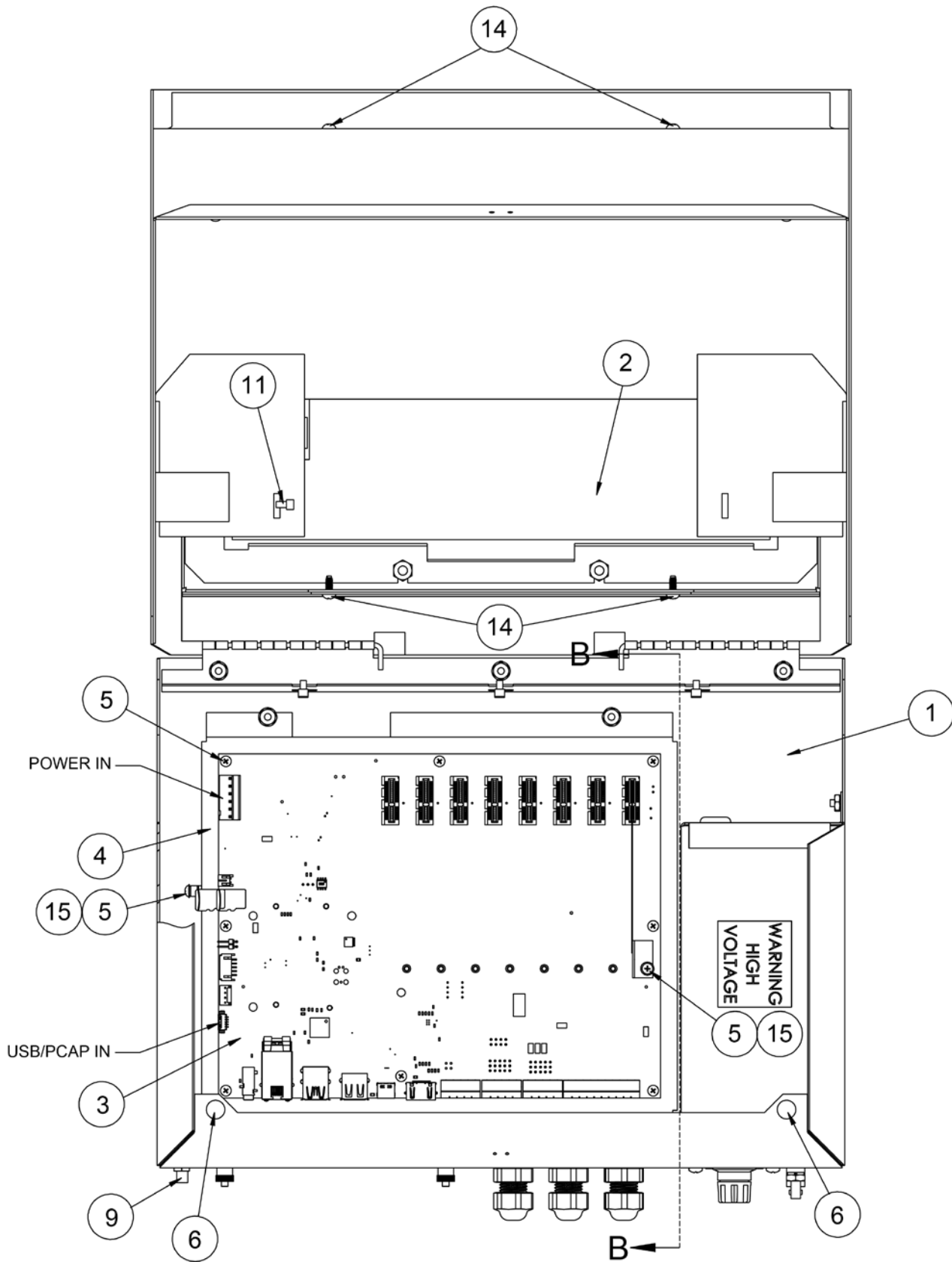
PARTS IDENTIFICATION

Final Assembly – ISO View



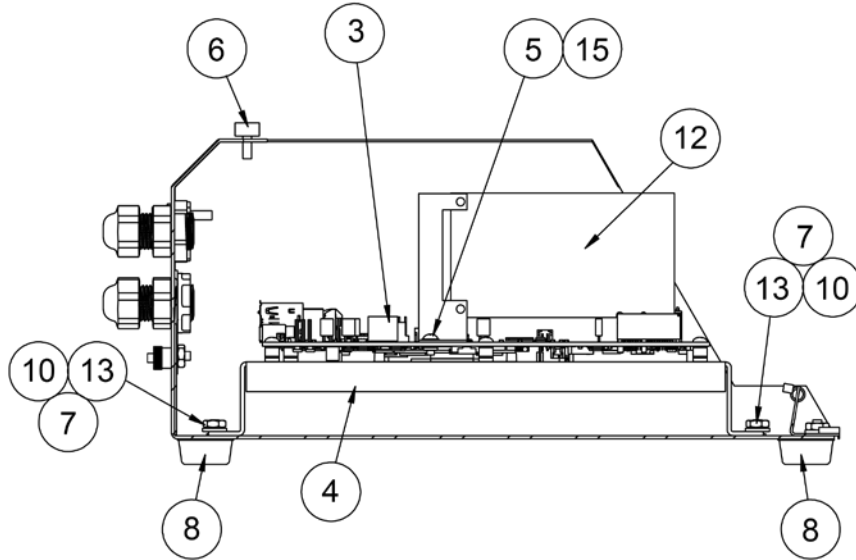
PARTS IDENTIFICATION

Final Assembly – Open Flat View

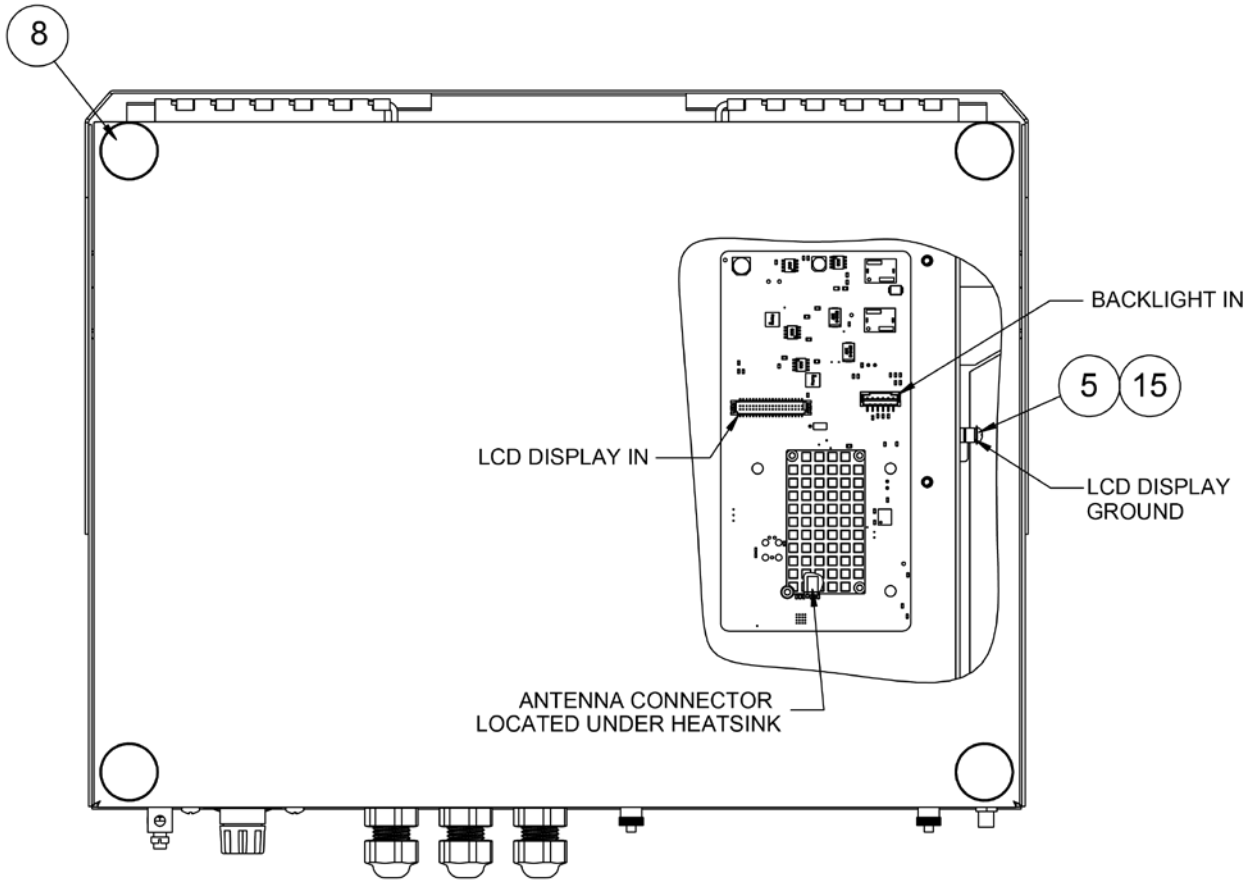


PARTS IDENTIFICATION

Final Assembly – Section B-B View



Final Assembly – Bottom View



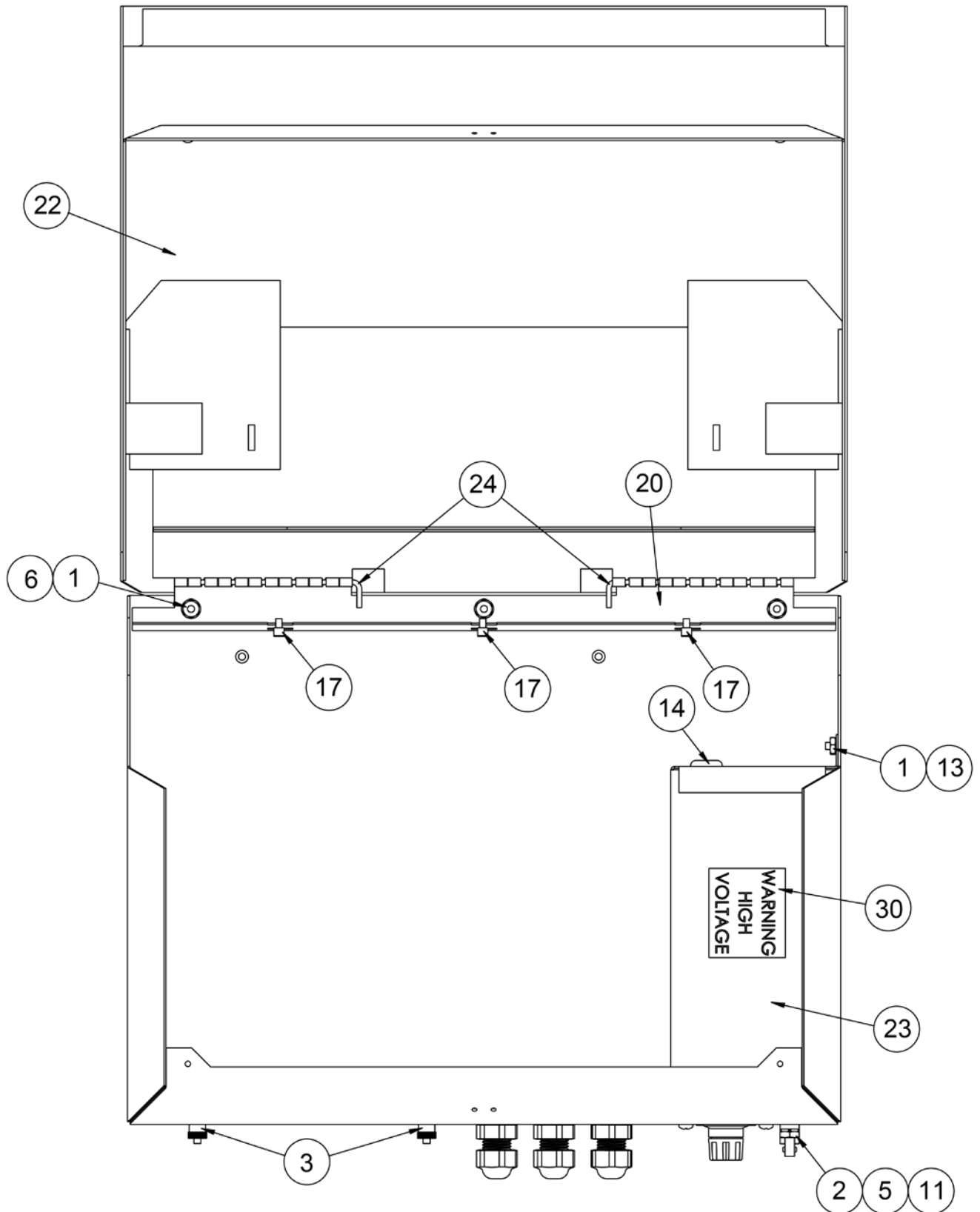
PARTS IDENTIFICATION

Rear Enclosure Parts List

ITEM NO.	QTY	PART NUMBER	DESCRIPTION
1	10	6013-0039	NUT, #6-32, Z/P
2	1	6013-0297	NUT, #10-32, HEX, SS
3	2	6013-0445	NUT, THUMB, KNURLED PLASTIC, #6-32
4	2	6021-0666	SCW, PAN-HEAD, MACHINE-SCW, 06-32 X 0.250
5	1	6024-0037	WASHER, LOCK HELICAL, SP, #10 REG, SS
6	5	6024-1022	WASHER, FLAT, #6 TYPE A, Z-PLATE
7	1	6610-1508	NUT, LOCK, NICKEL PLATED, PG 9 THREAD, 18MM HEX, FOR EMC
8	5	6610-2248	CONN GLAND 0.187 - 0.312 GRIP
9	1	6610-2451	FUSE HOLDER, 3AG 3/16 PUSH-ON-TERMINALS, UL APPROVED
10	1	6610-4004	FUSE, 1 ASB, 3AG
11	1	6610-5002	GROUND LUG, L-35
12	1	6610-5220	CONN GLAND 0.236 - 0.315 GRIP, 0.598 MTG, NICKEL, PG9
13	4	6680-0004	WASHER, LOCK, INT TOOTH, #6 TYPE A, Z-PL
14	1	6680-0067	GROMMET, 1/4 IN ID X 5/8 IN OD, 1/8 IN PANEL
15	1	6680-1107	SPACER, #4-40 X 0.750, 3/16, HEX, ALU., Z/P
16	1	6800-1091	POWER SUPPLY, UNIVERSAL INPUT, 96W 5V/6.0A, 24V/2.0A, 12V/1.5A
17	3	6980-0014	CABLE TIE, 4 IN WHITE
18	1	8544-B032-0A	FILTER ,RFI, ONE-FILTER, 6-AMP, UL APPROVED
19	1	8545-1076-0A	CABLE, SWITCH, A/C POWER
20	1	8545-1117-08	825 DESKTOP, BASE HINGE
21	1	8545-1118-0A	825 DESKTOP, BASE WELDMENT
22	1	8545-1123-0A	825 DESKTOP, LID WELDMENT
23	1	8545-1124-08	825 DESKTOP, POWER SUPPLY COVER
24	2	8545-1125-08	825 DESKTOP, HINGE PIN
25	1	8545-1129-0A	825 DESKTOP, IO COVER WELDMENT
26	2	8545-1165-0A	CABLE, SWITCH, A/C POWER
27	2	8545-1166-0A	POWER CABLE ASSEMBLY 24 IN
28	1	8545-1192-08	825 DESKTOP, POWER SUPPLY BRACKET
29	1	8545-B517-0A	WIRE ASSY, FUSE HOLDER, SWITCH/LINE, FILTR
30	1	8510-C346-0I	LABEL, WARNING HIGH VOLTAGE

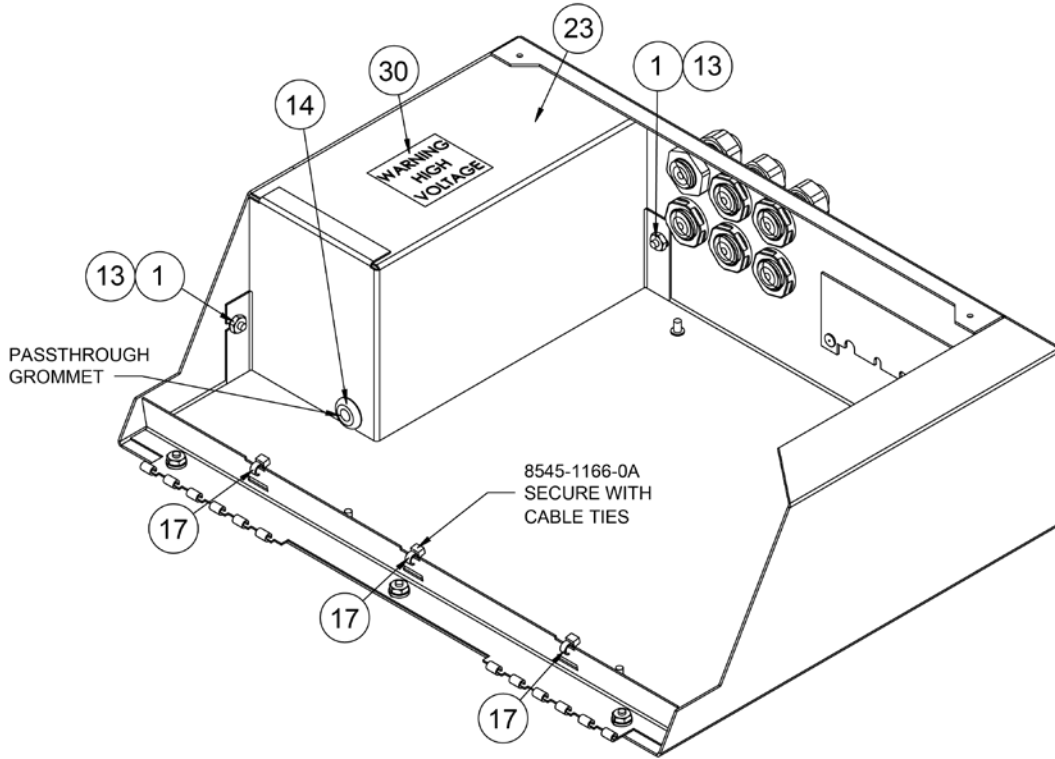
PARTS IDENTIFICATION

Rear Enclosure – Open Flat View

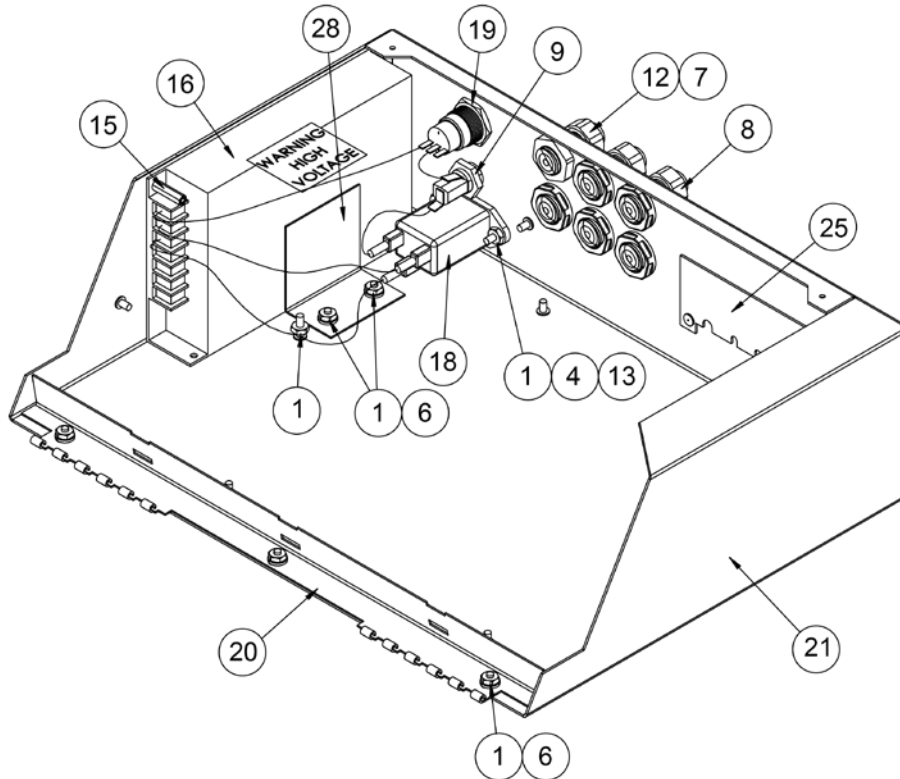


PARTS IDENTIFICATION

Rear Enclosure – Base Assembly, No Lid View



Rear Enclosure – Base Assembly, No Lid, No Power Supply Guard View



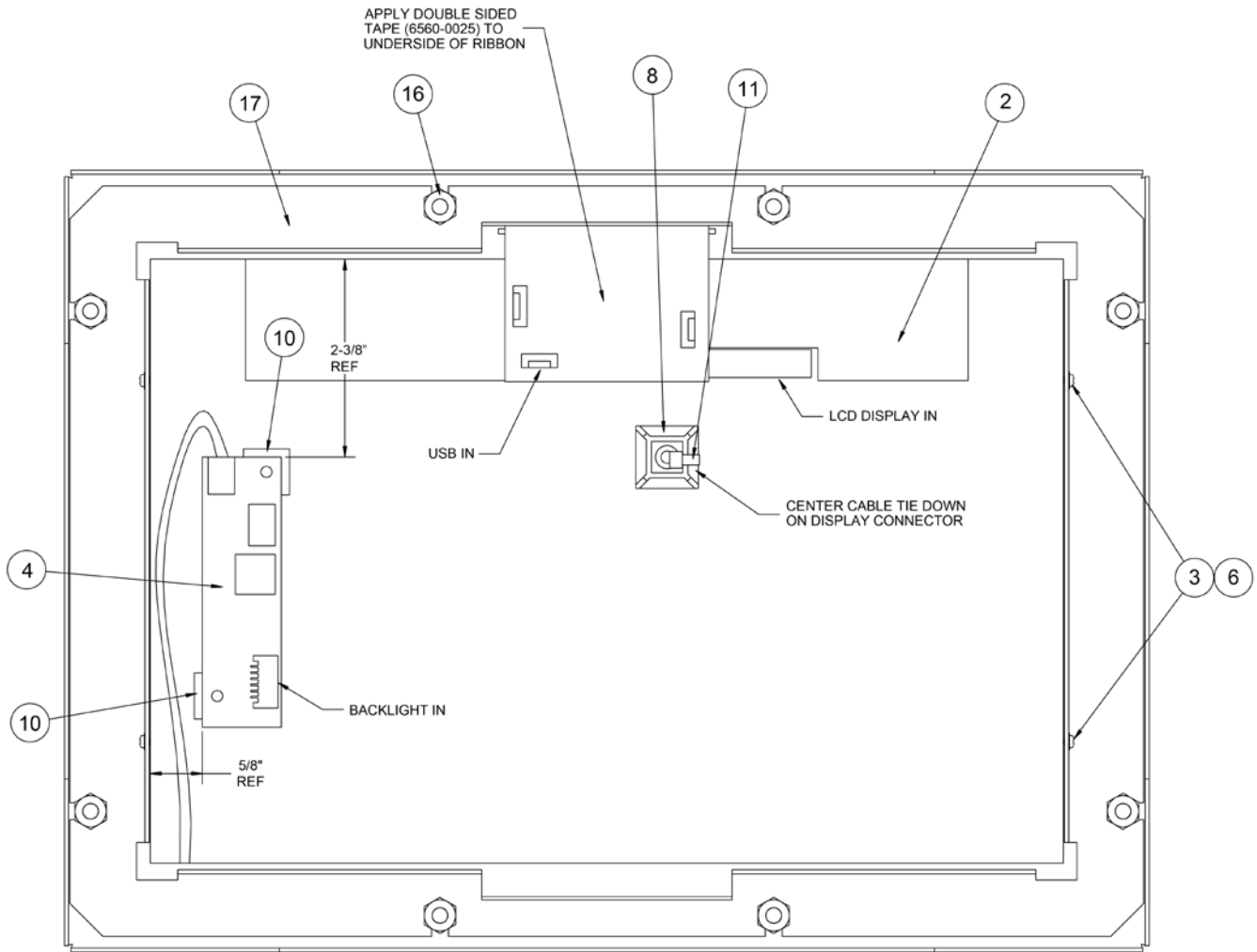
PARTS IDENTIFICATION

Desktop Screen Assembly Parts List

ITEM NO.	QTY	PART NUMBER	DESCRIPTION
1	1	8545-1127-0A	825 DESKTOP, SCREEN PLATE WELDMENT
2	1	6645-2263	DISPLAY, LCD GRAPHIC TFT 12.1 IN, 1280X800, 1000 NIT LED, PCAP TOUCH
3	4	6021-1298	SCW, NARROW CHEESE HEAD PHILLIPS, M2 X 0.4MM X 4MM, 3.8MM HEAD DIA., SS
4	1	6800-1063	LED BACKLIGHT DRIVER FOR 12.1 IN DISPLAY
5	0.02	6710-0086	TAPE, GAFFER'S, 1/2" WIDE X 180 FOOT (ROLL), BLACK
6	4	6024-0202	WASHER, LOCK ,HELICAL SP, M2 REG, SS
7	0.001	6560-0025	TAPE, DBL-SIDED 0.75 IN WIDE, 45 MIL THICK
8	1	6680-0028	CRADLE MOUNT FOR CABLE TIE 3/4 IN X 3/4 IN
9	8	6680-0256	SPACER, 0.192 IN ID X 0.375 IN OD X 0.156 IN LONG, NYLON
10	2	6680-1009	SPACER, SELF-ADHESIVE, PCB - SNAP-LOCK, 0.137 HOLE, 0.138 LENGTH
11	1	6980-0014	CABLE TIE, 4 IN WHITE
12	1	8545-0990-08	12.1 IN LCD PANEL LVDS CABLE
13	1	8545-0993-08	CABLE, TOUCHSCREEN, USB INTERFACE
14	1	8545-1042-08	CABLE, BACKLIGHT INVERTER POWER
15	1	8545-1053-08	825 TS, DISPLAY GASKET
16	8	6013-0295	NUT, #10-32 HEX, Z/P
17	1	8545-1159-08	12.1 TOUCH SCREEN SUPPORT FRAME, COMPACT

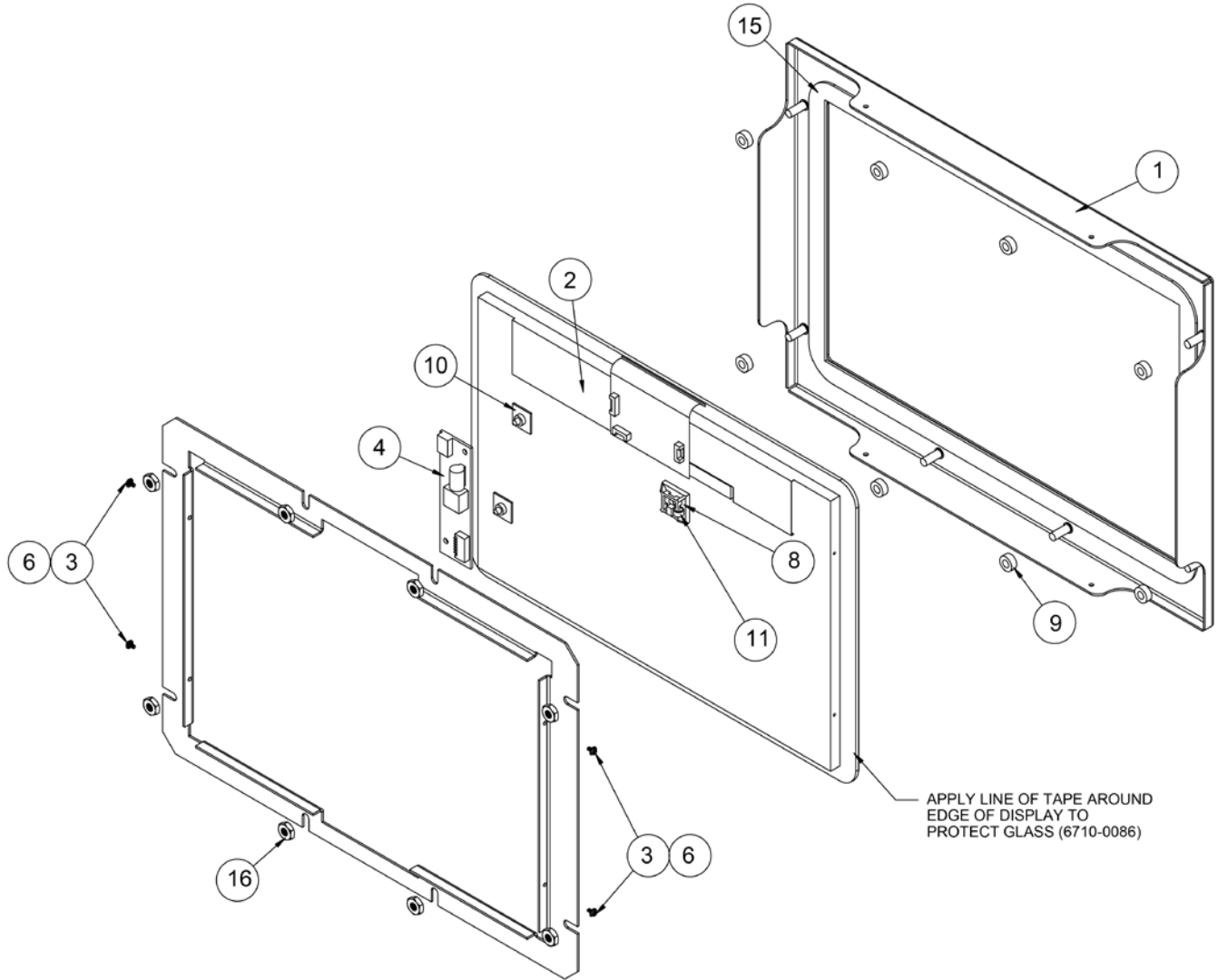
PARTS IDENTIFICATION

Desktop Screen Assembly – Rear View



PARTS IDENTIFICATION

Desktop Screen Assembly – Exploded View



STATEMENT OF LIMITED WARRANTY

WARRANTY TERMS

Cardinal Scale Manufacturing Company warrants the equipment we manufacture against defects in material and workmanship. The length and terms and conditions of these warranties vary with the type of product and are summarized below:

PRODUCT TYPE	TERM	MATERIAL AND WORKMANSHIP	LIGHTNING DAMAGE See note 9	WATER DAMAGE See note 7	CORROSION See note 4	ON-SITE LABOR	LIMITATIONS AND REQUIREMENTS
WEIGHT INDICATORS	90 DAY REPLACEMENT ----- 1 YEAR PARTS	YES	YES	YES	YES	NO	1, 2, 3, 5, 6 A, B, C, D
LOAD CELLS (Excluding Hydraulic)	1 YEAR	YES	YES	YES	YES	NO	1, 2, 3, 5, 6 A, B, C, D
HYDRAULIC LOAD CELLS (When purchased with Guardian Vehicle Scale)	LIFETIME	YES	YES	YES	YES	90 DAYS	1, 5, 6, 8 A, B, C, D
HYDRAULIC LOAD CELLS (When purchased separately)	10 YEARS	YES	YES	YES	YES	NO	1, 5, 6, 8, 9 A, B, C, D
VEHICLE SCALE (Deck and Below Excl. PSC Series)	5 YEARS	YES	YES	YES	YES	90 DAYS	1, 2, 3, 5, 6 A, B, C, D, E
LSC SCALE (Deck and Below)	3 YEARS	YES	YES	YES	YES	90 DAYS	1, 2, 3, 5, 6, 11 A, B, C, D
GUARDIAN FLOOR SCALES	10 YEARS	YES	YES	YES	YES	NO	1, 2, 3, 5, 6, 9, 10 A, B, C, D
ALL OTHER CARDINAL PRODUCTS	1 YEAR	YES	YES	YES	YES	NO	1, 2, 5, 6 A, B, C, D, E
REPLACEMENT PARTS	90 DAYS	YES	YES	YES	YES	NO	1, 2, 4, 5, 6 A, B, C, D
SWIM AND 760 SERIES VEHICLE SCALES	1 YEAR	YES	YES	YES	YES	90 DAYS	1, 2, 5, 6 A, B, C, D
SOFTWARE	90 DAYS	YES	N/A	N/A	N/A	NO	1, 6 B, C, D
CONVEYOR BELT SCALES (including Belt-Way)	1 YEAR	YES	YES	YES	YES	NO	1, 2, 3, 5, 6 A, B, C, D, E, F



CARDINAL

Ph. (800) 441-4237
E-mail: cardinal@cardet.com
102 E. Daugherty
Webb City, MO 64870

04/24
Printed in USA
315-WARRANTY-CAR-M

APPLICABLE LIMITATIONS AND REQUIREMENTS

1. This warranty applies only to the original purchaser. The warranty does not apply to equipment that has been tampered with, defaced, damaged, or had repairs or modifications not authorized by Cardinal or has had the serial number altered, defaced or removed.
2. This warranty is not applicable to equipment that has not been grounded in accordance with Cardinal's recommendations.
3. This equipment must be installed and continuously maintained by an authorized Cardinal / Belt-Way dealer.
4. Applies only to components constructed from stainless steel.
5. This warranty does not apply to equipment damaged in transit. Claims for such damage must be made with the responsible freight carrier in accordance with freight carrier regulations.
6. Warranty term begins with date of shipment from Cardinal.
7. Only if device is rated NEMA 4 or better or IP equivalent.
8. Lifetime warranty applies to damages resulting from water, lightning, and voltage transients and applies only to the hydraulic load cell structure itself (does not include pressure transducers, rubber seals, o-rings, and associated wiring).
9. 10-Year prorated warranty on hydraulic load cells.
10. 1-Year warranty for scale structure.
11. PSC models' warranty coverage applies only to agricultural installations on farms up to 3,000 acres (LSC models not limited in this manner).
12. Load cell kits MUST be installed in accordance with Cardinal Scale instructions. Failure to follow these instructions will void the warranty.

EXCLUSIONS

- A.) This warranty does not include replacement of consumable or expendable parts. The warranty does not apply to any item that has been damaged due to unusual wear, abuse, improper line voltage, overloading, theft, fire, water, prolonged storage or exposure while in purchaser's possession or acts of God unless otherwise stated herein.
- B.) This warranty does not apply to peripheral equipment not manufactured by Cardinal. This equipment will normally be covered by the equipment manufacturer's warranty.
- C.) This warranty sets forth the extent of our liability for breach of any warranty or deficiency in connection with the sale or use of our product. Cardinal will not be liable for consequential damages of any nature, including but not limited to loss of profit, delays or expenses, whether based on tort or contract. Cardinal reserves the right to incorporate improvements in material and design without notice and is not obligated to incorporate said improvements in equipment previously manufactured.
- D.) This warranty is in lieu of all other warranties expressed or implied including any warranty that extends beyond the description of the product including any warranty of merchantability or fitness for a particular purpose. This warranty covers only those Cardinal products installed in the forty-eight contiguous United States and Canada.
- E.) This warranty does not cover paint coatings due to the variety of environmental conditions.
- F.) Do not cut load cell cables on load cells returned for credit or warranty replacement. Cutting the cable will void the warranty.
- G.) Software is warranted only for performance of the functions listed in the software manual and/or the Cardinal proposal.
- H.) The software warranty does not cover hardware. Warranties on hardware are provided from the hardware vendor only.
- I.) The software warranty does not cover interfacing issues to non-Cardinal supplied hardware.
- J.) The software warranty does not include automatic software upgrades unless purchased separately.



Ph. (800) 441-4237
E-mail: cardinal@cardet.com
102 E. Daugherty
Webb City, MO 64870

04/24
Printed in USA
315-WARRANTY-CAR-M

Cardinal Scale Mfg. Co.

102 E. Daugherty, Webb City, MO 64870 USA

Ph: 417-673-4631 or 1-800-641-2008

Fax: 417-673-2153

www.cardinalscale.com

Technical Support: 1-866-254-8261

E-mail: tech@cardet.com

Printed in USA

8545-1151-0M Rev A 06/24